

Arnold Kiv
Serhiy Semerikov
Vladimir Soloviev
Liubov Kibalnyk
Hanna Danylchuk
Andriy Matviychuk
(Eds.)



**Experimental Economics
and Machine Learning for Prediction
of Emergent Economy Dynamics**

**Proceedings of the Selected Papers of the
8th International Conference on Monitoring,
Modeling & Management of Emergent Economy
(M3E2 2019)**

Odessa, Ukraine
May 22-24, 2019

Kiv, A., Semerikov, S., Soloviev, V., Kibalnyk, L., Danylchuk, H., Matviychuk, A. (Eds.): Experimental Economics and Machine Learning for Prediction of Emergent Economy Dynamics, Proceedings of the Selected Papers of the 8th International Conference on Monitoring, Modeling & Management of Emergent Economy (M3E2 2019), Odessa, Ukraine, May 22-24, 2019, CEUR-WS.org, online

This volume represents the proceedings of the selected papers of the 8th International Conference on Monitoring, Modeling & Management of Emergent Economy (M3E2 2019), held in Odessa, Ukraine, on May 22-24, 2019. It comprises 38 papers dedicated to the experimental economics and machine learning that were carefully peer-reviewed and selected from 71 submissions.

Program Committee

Vitalina Babenko, V. N. Karazin Kharkiv National University, Ukraine
Oleksandr Chernyak, Taras Shevchenko National University of Kyiv, Ukraine
Hanna Danylchuk, Bohdan Khmelnytsky National University of Cherkasy, Ukraine
Maryna Drobotova, Bohdan Khmelnytsky National University of Cherkasy, Ukraine
Giedre Dzemydaite, Vilnius University, Lithuania
Irina Georgescu, Academy of Economic Studies, Romania
Lidiya Guryanova, Simon Kuznets Kharkiv National University of Economics, Ukraine
Alexey Hostryk, Odessa National Economic University, Ukraine
Pavlo Hryhoruk, Khmelnytskyi National University, Ukraine
Liubov Kibalnyk, Bohdan Khmelnytsky National University of Cherkasy, Ukraine
Lyudmyla Kirichenko, Kharkiv National University of Radio Electronics, Ukraine
Arnold Kiv, Ben-Gurion University of the Negev, Israel
Konstantin Kovalchuk, National Metallurgical Academy of Ukraine, Ukraine
Oksana Kovtun, Staropolskia Szkoła Wyższa w Kielcach (Centrum kształcenia w Czerkasach), Ukraine
Hanna Kucherova, Classic Private University, Ukraine
Nataliia Maksyshko, Zaporizhzhia National University, Ukraine
Andriy Matviychuk, Kyiv National Economic University named after Vadym Hetman, Ukraine
Tamara Merkulova, V. N. Karazin Kharkiv National University, Ukraine
Nikolaos Passalis, Tampere University, Finland
Lukas Pichl, International Christian University, Japan
Oleg Pursky, Kyiv National University of Trade and Economics, Ukraine
Serhiy Semerikov, Kryvyi Rih State Pedagogical University, Ukraine
Lyudmila Sergeyeva, Zaporizhzhia State Medical University, Ukraine
Yaroslav Shramko, Kryvyi Rih State Pedagogical University, Ukraine
Vladimir Soloviev, Kryvyi Rih State Pedagogical University, Ukraine
Viktoriia Solovieva, Kryvyi Rih Economic Institute of Kyiv National Economic University named after Vadym Hetman, Ukraine
Valdemar Vitlinskyi, Kyiv National Economic University named after Vadym Hetman, Ukraine
Eugene Yakub, Odessa National Economic University, Ukraine
Nataliia Zachosova, Bohdan Khmelnytsky National University of Cherkasy, Ukraine
Pavel Zakharchenko, Berdyansk State Pedagogical University, Ukraine

Local Organization Committee Members

Aleksij Ya. Chebykin, South Ukrainian National Pedagogical University named after K. D. Ushynsky, Ukraine
Oleksandr V. Cherevko, Bohdan Khmelnytsky National University of Cherkasy, Ukraine

Deniss Djakons, Information Systems Management Institute, Latvia

Stanisław Dziekoński, Cardinal Stefan Wyszyński University in Warsaw, Poland

Heinz W. Engl, University of Vienna, Austria

Chaim J. Hames, Ben-Gurion University of the Negev, Israel

Leonid V. Hubersky, Taras Shevchenko National University of Kyiv, Ukraine

Andrei D. Karol, Belarusian State University, Republic of Belarus

Dmytro G. Lukianenko, Kyiv National Economic University named after Vadym Hetman, Ukraine

Andrzej Chochół, Cracow University of Economics, Poland

Yaroslav Shramko, Kryvyi Rih State Pedagogical University, Ukraine

Artūras Žukauskas, Vilnius University, Lithuania

Experimental Economics and Machine Learning for Prediction of Emergent Economy Dynamics

Arnold Kiv

Ben-Gurion University of the Negev, P.O.B. 653, Beer Sheva, 8410501, Israel
kiv@bgu.ac.il

Serhiy Semerikov^[0000-0003-0789-0272], Vladimir Soloviev^{2[0000-0002-4945-202X]}

Kryvyi Rih State Pedagogical University, 54, Gagarin Ave., Kryvyi Rih, 50086, Ukraine
{semerikov, vnsoloviev2016}@gmail.com

Liubov Kibalnyk^[0000-0001-7659-5627], Hanna Danylchuk^[0000-0001-9240-1976]

Bohdan Khmelnytsky National University of Cherkasy, 81, Shevchenko Blvd., Cherkasy,
18000, Ukraine
liubovkibalnyk@gmail.com, abdanilchuk@gmail.com

Andriy Matviychuk^[0000-0002-8911-5677]

Kyiv National Economic University named after Vadym Hetman, 54/1, Peremogy Ave., Kyiv,
03680, Ukraine
editor@nfimte.com

Abstract. This is an introductory text to a collection of selected papers from the M3E2 2019: The 8th International Conference on Monitoring, Modeling & Management of Emergent Economy, which was held in Odessa, Ukraine, on the May 22-24, 2019. It consists of short introduction and some observations about the event and its future.

Keywords: experimental economics, machine learning, prediction of emergent economy dynamics.

1 Introduction

Nowadays in conditions of the world space transformation, the role of individual countries and their groups varies considerably. Priorities for ensuring sustainable growth of the world economy are distributed between countries and their groups unevenly. It is influenced by the global economic situation cycles, by potential and possibilities for realizing the achievements of information and technological progress, by the newest dominant tendencies of geographic and regional development, etc. As a result, some countries are ahead of others in the terms of economic growth. The specificity of the modern world economic system lies in the fact that global economic

growth depends on the implementation of national economic potential, the ability to apply existing and acquired factors of economic dynamics at the level of individual countries.

One of the key characteristics of the structure of the modern world economy is the presence of a group of countries with emergent markets. The established classification of countries with growing (ascending, emergent) markets in the scientific literature is not formed, however, there are several research approaches regarding the content and criteria for identifying this group of countries. According to world-class scientists such as V. Kvint [1], T. Marois [2], M. A. Kose and E. S. Prasad [3], as well as according to international financial institutions, research centers (such as the British company FTSE, the corporation MSCI, the American financial company S&P, the American financial information firm Dow Jones & Company, Frontier Strategy Group, etc.), that deeply studied this problem, the formation of emergent markets in the world is associated with the presence of four main characteristics.

The essence of the first one is that this group includes countries with a large population, resource base and high-volume markets, that are the engines of economic development in different regions of the world. The second feature is the transitive type of society, and specifically – implementation of internal economic and political reforms, the introduction of a policy of “openness” instead of a policy of strong state planning and control. The next feature is high rate of economic growth, as a result of the country’s active participation in international trade process. And the last feature is the significant growth of domestic and foreign investments due to the formation of a favorable environment for conducting business within the country.

At the same time, according to the experts of the Institute of Economics and Forecasting of the National Academy of Sciences of Ukraine, the issues of determining clear criteria for classification of countries belonging to this group remain unsolved, especially with relatively small area of the territory (less than 1 million square kilometers), as well as with limited market liquidity (in particular, Ukraine).

According to their opinion in Ukraine the problems of the intensification of the processes of emergence of the economy are hampered by the problems of low innovation activity of domestic enterprises, the volatility of foreign economic activity and the instability of the political situation. Therefore, we offer some steps towards the formation of well-developed emergency economics in Ukraine. Among them: the financing of technological parks through venture capital funds with a minimum state participation, which should be the guarantor of the reliability of private investment; the creation of a stock market, the forecasts of which will allow you to navigate the dynamics of stock quotes, that in the case of coincidence of real and predicted values will indicate the correctness of the decisions on investing in certain innovative enterprises; commercialization of scientific developments at the expense of enterprises and research institutions entering the international market of innovative technologies by joining the system of technology transfer INDEV of the State Committee for Investment and Development, etc.

Publications in the scientific literature prove a high level of interest in the theoretical and applied developments concerning the peculiarities and dynamics of the development of the countries of the emergent type. However, questions about the

application of modern methods of investigation of the emergent properties of complex systems, sources and methods to the process of formation the emergent strategy of the country as a whole and Ukraine in particular are still remain insufficiently studied.

In modern science, the achievements of modern mathematics, system analysis, decision-making theory, and so on are used to model and analyze the complex systems functioning. At the same time, the processes of globalization and integration, financial and economic instability cause the need to find out new tools that take into account elements of uncertainty, a significant number of risks and promote the efficiency of simulation processes.

The scientific contribution of modern scholars can be a guarantee for the improvement of the activities of various economic actors, the basis for the development of operational and strategic plans and programs of business and government activities. This collection of scientific works includes the research results of scientists aimed at improving the existing and developing new approaches in the modeling, management and monitoring of the emergent economy as a complex system.

2 M3E2 2019 at a Glance

Monitoring, Modeling & Management of Emergent Economy (M3E2) is a peer-reviewed international conference focusing on research advances and applications of nonlinear dynamics methods, econophysics and complex systems methodology of emergent economy.

The M3E2 Conference occupies contributions in all aspects of Computational Finance, Economics, Risk Management, Statistical Finance, Trading and Market Microstructure, (Deep) Machine Learning technologies and tools, paradigms and models, relevant to modern financial engineering and technological decisions in the modern age. There is urgent general need for principled changes in postclassic economy elicited by current models, tools, services, networks and IT communication.

M3E2 topics of interest:

- Complex cyberphysical systems, synergy, econophysics, economy of agents.
- Mathematical methods, models, informational systems and technologies in economics.
- Monitoring, modeling, forecasting and preemption of crisis in socio-economic systems.
- Models of global transformations.
- Experimental economics.
- The dynamics of emergent markets in post crisis period.
- Management of the state's economic safety and economic safety of economic agents.
- Modeling of hospitality sphere development.
- Prioritized ways of formation of the innovation model of Ukrainian economical development.
- The Global Challenges for Economic Theory and Practice in CEE Countries.
- (Deep) Machine Learning for prediction of emergent economy dynamics.
- Risk Management models in emergent economy.

This volume contains the selected papers presented at M3E2 2019: The 8th International Conference on Monitoring, Modeling & Management of Emergent Economy held on May 22-24, 2019 in Odessa, Ukraine.

There were 71 submissions. Each submission was reviewed by at least 3, and on the average 3.1, program committee members. The committee decided to accept 38 papers.

3 Conclusion

The vision of the M3E2 2019 is provides a premier interdisciplinary platform for researchers, practitioners and educators to present and discuss the most recent innovations, trends, and concerns as well as practical challenges encountered and solutions adopted in the fields of emergent economy.

The conference has successfully performing forum to transferring and discussing research result among the researcher, students, government, private sector or industries. Participants and presenters from several countries such as Czechia, Italy, Israel, Lithuania, Poland, Slovenia, Ukraine have attended the conference to share their significant contribution in research related to Monitoring, Modeling & Management of Emergent Economy.

We are thankful to all the authors who submitted papers and the delegates for their participation and their interest in M3E2 as a platform to share their ideas and innovation. Also, we are also thankful to all the program committee members for providing continuous guidance and efforts taken by peer reviewers contributed to improve the quality of papers provided constructive critical comments, improvements and corrections to the authors are gratefully appreciated for their contribution to the success of the conference [4].

We hope you enjoy this conference and meet again in more friendly, hilarious, and happiness of further M3E2 2020.

References

1. Kvint, V.: Strategy for the Global Market: Theory and Practical Applications. Routledge, New York (2016)
2. Marois, T.: Towards a Green Public Bank in the Public Interest. UNRISD Working Paper 2018-3. <http://hdl.handle.net/10419/186113> (2018). Accessed 21 Mar 2019
3. Kose, M.A., Prasad, E.S.: Emerging Markets: Resilience and Growth amid Global Turmoil. Brookings Institution Press, Washington (2010)
4. Semerikov, S., Soloviev, V., Kibalnyk, L., Chernyak O., Danylchuk, H.: M3E2 2019 - Towards a new economy in the public interest. SHS Web of Conferences. **65**, 00001 (2019). doi:10.1051/shsconf/20196500001

Modeling Expectations of Resort-Tourist Market

Pavel Zakharchenko^[0000-0001-5025-797X], Anna Kostenko,
Tatyana Kungurtseva-Mashchenko and Illona Gorbachova

Berdiansk State Pedagogical University, 4, Schmidta str., Berdyansk, 71100, Ukraine
pvzz1957@gmail.com, annkosten@rambler.ru,
tanyakungurtseva2704@gmail.com, azhigir@gmail.com

Abstract. In modern world economy resort recreations is one of the most high-profitable spheres of managing. Ukraine owns the powerful resort and tourist potential, to which effective development can bring a real economic benefit. For this purpose, it is necessary to form of system concept for the development of such systems, which are integral part of the economic transformations. Transformational processes are displayed in shifts in consumption, requirements and ways of their satisfaction. The market environment needs are in the form of demand and ways to meet them mediated by the market in the form of market expectations. They are important for forecasting the behavior of the market of resort and tourist products. As a result, of research was the model of dynamics of trust of the market to transformational changes of the resort and tourist sphere of Ukraine is constructed. Scenarios of change of level of trust at various values of parameters, which correspond to stages of development of transformational economy are received.

Keywords: resort-tourist market, modeling, model of dynamics of trust of the market.

1 Introduction

In the modern world economy resort-recreation and tourism activity is one of highly profitable spheres, as well as one of the most dynamically developing. For many countries this is not only constantly growing a source of financial revenues, but also due to attraction of millions of tourists as a source of infrastructure development for the territories, creating additional jobs.

Ukraine has a powerful resort-recreation and tourist potential, the effective use of which can ensure not only full satisfaction of the needs of the population in such services, but also bring real economic benefits. Therefore resort-recreation and tourism spheres in the process of market transformation of the economy should take one of the leading places in the structure of the economic complex. Such a perspective for national resort and tourist complexes is intended to provide appropriate methodologies for systemic economic transformations, based on modern concepts of research of complex economic systems and, first of all, by methods of system research and economic-mathematical modeling.

The problem of the transformation of economic systems has deep grounds in the problem of general economic theory. The problems of the formation, development, and change of economic systems, which were investigated in the works of many scientists throughout the long period of time, are directly related to it. In the process of the research of economic transformation of resort and tourist systems the authors relied on the theoretical developments which are contained in works of M. Bokov [1], M. Amirkhanov [2], A. William [3], E. Inskeep [4], A. Shekhovtseva [5] and other scientists [6-8].

Researches of accounting for expectations in the economic systems is presented in the writings of J. Keynes [9] and J. Hicks [10], who emphasized that expectations are part of the system, while fulfilling the role of the exogenous factor, but not the element which is formed in the analyzed process.

Historically the first researcher who formulated the hypotheses underlying the theory of rational expectations was J. Muth [11]. His idea was picked up and applied to a large range of economic models by R. Lucas. [12] As a result of it, the principle of rational expectations has been recognized as the theoretical basis for new research, including surveys of the resort and tourist economics.

2 Methodological Aspect of a Research of Expectations of the Resort-Tourist Market

Economic transformations of the resort and tourist economy represent large-scale and deep transformations of a system character. They have their own regularities, the detection of which allows not only to estimate their current state, but also to forecast trends in development. Transformation processes are reflected in shifts in consumption, needs and ways to meet them. In a market environment the needs are in the form of demand, and the ways of their satisfaction are mediated by the market in the form of market expectations.

The concept of “market expectation” was formed on the basis of provisions of probability theory and psychology. It is important for forecasting market behavior, and, consequently, the functioning of the transformational economy. As G. Hodgson [13] noted, the effectiveness of influence of expectations in transformational economies is not lower than in the developed and stable economies. Thus, there is a need of justification of content of expectations, explanations their role as ekzo- and endogenous factors of the economic system and development of the corresponding models of forecasting, in particular for the market of resort and tourist products. Expectations of economic entities are usually not studied as separate objects of analysis, but they are investigated in the form of “embedding” expectations in the transformational functioning of economic systems.

In the modern economic theory [14] allocate two types of expectations: “ex post” and “ex ante”. Expectation of “ex post” is the assessment given by the subjects of the economy after the completion of the considered process. They are accounted for mainly in empirical verification of theoretical concepts or in calculating the actual indicators of economic development based on the system of national account. Expectation of “ex

ante” is future plans and intentions of economic subjects, which define the nature of the decisions which they make. The formation of economic subjects of rational expectations, “ex ante” is of direct interest to the analysis of the transformational processes in the resort-tourism economy as a mechanism for market self-regulation.

The theory of expectations allocates three types of expectations of “ex ante”: static, adaptive, rational.

Static expectations assume that in the future economic subjects are guided by the same parameters of an environment, which take place today. That is the simplest rule in decision-making for economic subjects will work this year as and in previous.

According to the theory of adaptive expectations, economic subjects build the behavior on the basis of past experience, but adjust the expectations, first, taking into account wrong estimates of the past, secondly, taking into account obvious changes of an economic environment.

Rational expectations provide that economic subjects form the plans and build the behavior, proceeding from the analysis of all of information available at the moment. Rationally acting economic subjects not only consider experience past mistakes, but also look in the future. Making the decision, they rely on own representations concerning model of management of economy and attract all available information on the expected events which can affect an economic environment. As a result it turns out that subjects, forming the forecasts, do it in the same way, as well as the market, that is, without allowing systematic mistakes.

One of the most important problems of the transformational economy is the level of confidence in transformational changes by economic agents, since, in case of its absence or low level, they can not achieve their goals [15]. According to the ideas of a number of researchers [16], the market system works to a large extent thanks to trust. In the act of trust, the complexity of the future is minimized. Trusting, the agent acts as if the future provides only strictly certain variants of the development of events. Rational trust: people use their available information to make the forecast, and then on its basis to make a decision. As the analysis of past experience provides risk assessment, formation of expectations generation and focus on future results, allocated strategic or based on knowledge trust (strategic or knowledge based trust) [17]. In this case the decision on trust is taken in the same way as the investment scheme: the efficiency of the decision on trust is determined in the long term by the results of the implementation of economic transformations.

The institute of trust helps subjects of the market to determine institutionally market space that in turn reduces uncertainty level. The level of credibility depends on such circumstances as:

- accounting of economic transformations by economic agents of past experience in sectors of economy;
- stability of national economy;
- international experience of development of economic systems, including, systems of a certain orientation [18].

At the same time it should be noted that the inefficiency of transformational strategy is connected not with a set of these or those tools, and it is caused by reaction of economic

agents to the expected results from these economic transformations. Thus, the trust can be considered as one of the built-in regulating mechanisms of the market and economy in general. It is one of the most important determinants of distribution of investments and consumer demand.

In the relation to the market of resort-recreation products, we will consider a hypothesis of imperfection of information, which consists in recognition of differences in knowledge of agents of price dynamics depending on degree consumption of the corresponding resort products by them. It is supposed that agents are better informed on the prices on resort-recreation products, which they make and sell, than about the prices of other products which they buy. Let's show it on the basis of use "island" models.

The market of each individual resort-recreation product is similar to the island. Each agent, like an islander, does not have complete information about what is happening on other islands (or markets). Therefore, when there is an increase in prices for a resort-recreation product, he does not know exactly the reason for it.

He does not know if there is an increase in prices as a result of increased demand or an increase in the amount of money in circulation. Agents and firms operating in accordance with the concept of rational expectations regard the increase in prices for the resort-recreation market partly as a consequence of overall price increases, and partly as a result of the change in the relative price of the resort-recreation product due to its innovation.

Respectively, even if advance in price of a product it is quite caused by the general rise in prices, then rationally conceiving agent all the same assumes that the relative price of a resort product also grew by a certain size. As a result it expands production, other islanders - agents join it, and in resort-recreation economy rise is observed.

Thus, application of the theory of rational expectations provides attraction of the mechanism of market self-regulation of economy in resort-recreation economy. During the competition all levers of self-regulation are put in action, it is effective self-regulation a resort-recreation system and providing its balance.

Rational expectations promote clearing of the market of resort-recreation products, its reduction to a state when stability of recreational economy as economic agents can react more flexibly to any deviations of an economic environment is provided, work according to the principles of optimization, being guided by real economic indicators and results.

3 Model Expectations of Resort-Tourist Market

An important role in the dynamics of confidence level is played by both the process of natural self-development of trust and the crisis of confidence. Natural self-development of trust arises in the case when the party fulfills its obligations, confidence in it increases; as a consequence, either the demand for the product increases or investment increases. Confidence crisis means a situation in which a party fails to fulfill its obligations; as a result, the trust in it falls sharply [19]. For the analysis of these

processes, we will construct model of the dynamics of trust in the resort and tourist market by transformational changes of the resort and tourism sphere of activity.

Let X be the amount of free capital that can be provided to companies resort and tourism sphere. According to the principle of natural increase of trust, while companies carry out transformation changes in order to produce an innovative resort and tourist product, trust in them is growing. Let Y be the amount of funds for those companies that do not transform changes. Let's describe the dynamics of the change of these variables with the help of the following model

$$\begin{aligned}\frac{dX}{dt} &= \alpha_1 X - \alpha_2 XY \\ \frac{dY}{dt} &= -\beta_1 Y + \beta_2 XY\end{aligned}\tag{1}$$

The parameter α_1 reflects the growth rate to the companies in the tourist and tourist sphere depending on already carried out economic transformations. The value of the parameter α_1 depends on the psychological factors. In particular, the index can be used to determine this parameter: investor confidence indices, consumer confidence indices, consumer expectations indices, consumer confidence indices, etc. In essence, this parameter reflects the trust of a large number of investors. Obviously, the parameter α_1 tends to increase in the case of the effectiveness of transformational changes and to decrease in the absence of them.

The parameter α_2 reflects the intensity of loan of means by inefficient companies, that is such which do not make transformational changes. Gain of loans proportional as quantity Y , since, the larger the resort company, the more it needs the funds to function, and the quantity X – since, the more free capital in the market, the greater the potential for growth of companies that carry out economic transformations.

The parameter β_1 reflects the speed of insolvency of inefficient resort and tourism companies without external financing. As a parameter estimate, you can use the ratio of the following form: “(company’s annual expenses - annual revenue) / (company’s assets)”. For small and medium resort and tourism businesses it makes sense to consider the parameter β_1 close to zero or even in the area of small negative values. The considerable share of growth in small and medium businesses is possible, precisely because it is initially a great deal of trust in it, and it grows on this trust until it becomes ineffective.

The parameter β_2 reflects the speed of growth in the volume of inefficient resort-tourism companies by attracting investment. The increase is proportional as quantity Y , since, the larger the resort company, the more money it can use to grow, and – because X , the more capital on the market, the easier it is to get investment funds.

4 Simulation Results

For computer simulation used software package MathCad. Let's consider different scenarios, obtained as a result of modeling of dynamics of the level of trust at different values of parameters.

Scenario I. Incomplete or ineffective economic transformations in resort and tourist companies.

One scenario obtained when modeling the level of market confidence was a scenario, corresponding to the situation of incomplete or ineffective economic transformations in resort and recreation companies (Fig. 1).

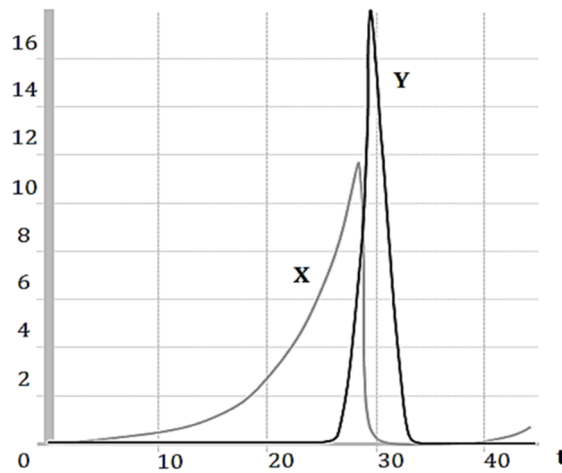

Fig. 1. Results of simulation of the dynamics of trust at $\alpha_1=0.2$, $\beta_1=0.8$, $\alpha_2=0.2$, $\beta_1=0.4$.

As can be seen from Fig. 1, the transformational changes lead to growth of trust of the market, which, accordingly, involves the flow of free capital into the resort and tourist market. Thus, an increase in the parameter X means the period of market growth. To a certain amount of free capital the market is successfully developing, which makes it possible to talk about the transformational rate of growth of resort tourism companies. At some stage (moment of time $t=28$), between peak X and crossing that goes up Y the inefficient companies begin to be formed.

Starting from this moment, the trust of the market falls, and the amount of free capital is decreasing. However, due to the inertia of the economy, this fact is not fixed by indicators, since a significant amount of capital is invested in resort and tourist companies, and in general the capitalization of the resort and tourism sphere grows (growth of value Y). Then comes the situation when the volume of the capital of inefficient companies reaches its peak (peak Y). This happens in the absence of new investments in these companies due to lack of trust. Due to the high importance of inefficiency ($\beta_1=0.8$), resort-tourism companies are rapidly losing profit and are forced to undergo economic transformation. Thus, a new transformation cycle begins.

Scenario II. The growth of completed economic transformations in resort and tourist companies.

Another scenario obtained when modeling trust of the market was a scenario, corresponding to the situation of the growth of the number of completed economic transformations in resort and tourist companies (Fig. 2).

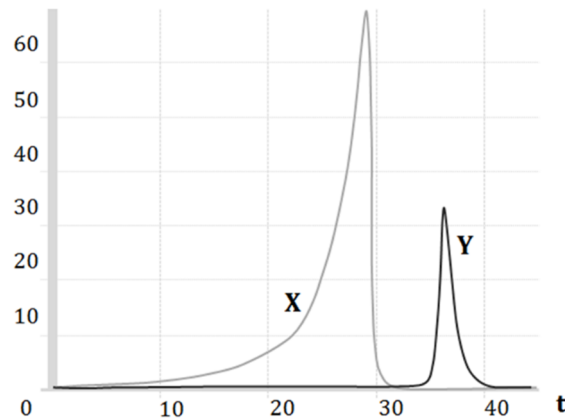

Fig. 2. Results of modeling of dynamics of trust at $\alpha_1=0.2$, $\beta_1=0.8$, $\alpha_2=0.2$, $\beta_1=0.2$.

The scenario is presented on Fig. 2 constructed on a basis the assumption that the volume of investment into ineffective resort-tourism companies will decrease in connection with reduction of trust of the market ($\beta_1=0.1$).

The completion of economic transformations in resort and tourist companies leads to growth of trust of the market and, consequently, an increase in free capital in this market. If, for whatever reason, economic transformations do not fully achieve their goals, then the market is seen as an ineffectiveness of their work. At the same time, the level of trust does not decrease.

Scenario III. Regulations of the market in the conditions of transformational economy.

The scenario presented in Fig. 3 shows a high level of market confidence, which, accordingly, leads to a much larger accumulation of free capital (compared to scenario 1). For modeling of such scenario of trust resort and tourist the market we will reduce some parameters of model. On Fig. 3 the scenario of the regulated market in the conditions of transformational economy is shown.

In the conditions of transformational economy, market regulators seek not to allow a market collapse. It is reached in the different ways, but with one purpose: to prevent the emergence of obviously inefficient resort-tourism companies by reducing the opportunities for attracting investment in such companies. For modeling of such scenario of trust in the resort-tourism market we will reduce some parameters of the model. In Fig. 3 shows the scenario of a regulated market in a transformational economy ($\alpha_2=0.05$, $\beta_1=0.1$, $\beta_2=0.05$).

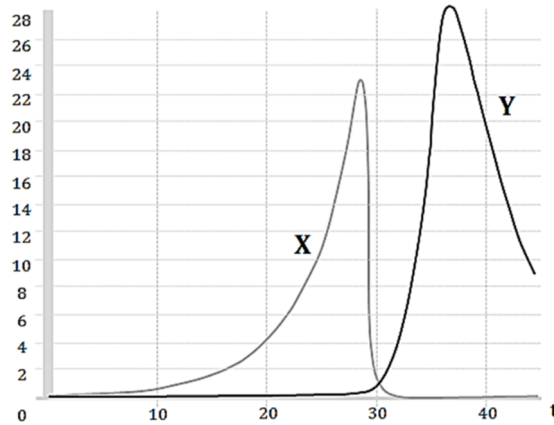

Fig. 3. Results of modeling of dynamics of trust at $\alpha_1=0.2$, $\beta_1=0.1$, $\alpha_2=0.05$, $\beta_2=0.05$.

It should be noted that in case of application to inefficient resort travel agencies decrease in trust, an opportunity to distance the beginning of the following transformational cycle exists the regulator of the market of the corresponding procedures.

The scenario is presented in Fig. 3 shows a high level of market confidence, which, accordingly, leads to a much larger accumulation of free capital (compared to scenario I). However, in this case, starting with a certain amount of free capital (the moment of time $t=30$), there is the emergence and development of inefficient resort and tourism companies. The emergence of such companies is mainly due to the incompleteness of economic transformations or the failure to achieve the objectives of transformational changes. It should be noted that if applied to ineffective resort and tourism companies regulating the market for appropriate procedures for reducing confidence, there is the possibility of delaying the start of the next transformation cycle.

Scenario IV. Weakly regulated or innovative market.

To one more scenario received when modeling trust of the market was the scenario corresponding to the situation of completing economic transformations in resort and tourist companies and transition to release of innovative resort and tourist products (Fig. 4).

The indicated scenario reflects the level of trust of the weakly regulated or innovative market. This market is characterized by a high intensity of loan of means by the inefficient companies ($\alpha_2=0.8$), growth of volume of their means by attraction of investments an ($\beta_2=0.8$), a large inefficiency of inefficiency ($\beta_1=0.5$), which constantly enters new investors ($\alpha_1=0.5$). The analysis of the scenario demonstrates the frequent change in market advantages at the expense of the high “growth rate of trust”, as well as the fact that the amplitude of the cyclical changes for X and Y is low. Consequently, the level of market trust is distributed between transformational and inefficient resort and tourism companies and there is no accumulation of free capital in certain companies.

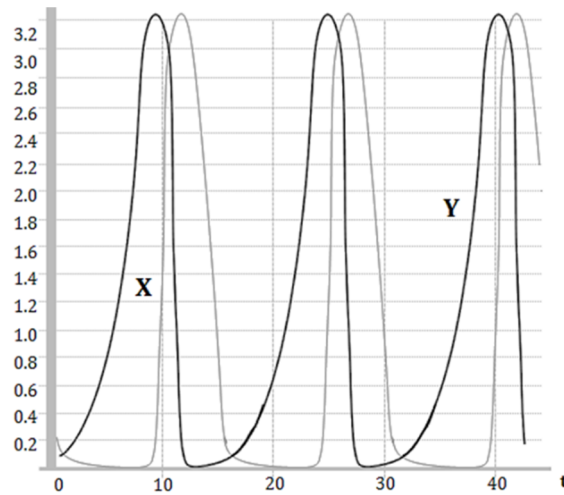

Fig. 4. Results of modeling of dynamics of trust at $\alpha_1=0.5$, $\beta_1=0.5$, $\alpha_2=0.8$, $\beta_2=0.8$.

5 Conclusions

The complex analysis of the role and place of resort-recreations in the development of the national economy and trends in changing their state in the process of European integration of the Ukrainian economy has been carried out. It has been shown that, as in many developed countries, this activity can be one of the most profitable and most dynamically developed spheres of the national economy. It also to be among the primary budget forming branches in case of transformation of management of economic processes on the basis of modern European paradigms and modern tools of their analysis.

An analysis of the current state and trends in the development of the world and domestic resort-recreation sphere has made it possible to conclude that the management of the economic development of the resort-recreation sphere in the present conditions should be based on the consideration of the nonlinear, stochastic nature of the flow of economic processes, both external and internal environment, inherent in the European. It is advisable to research these processes on the basis of innovation activity. It allows researching the development of complex socio-economic systems in the conditions of high degree of uncertainty of the external environment; systems of universal, general theoretical, specific principles and a set of basic concepts.

Thus, the analysis of the results of the modeling of the dynamics of confidence at different values of the parameters allows us to conclude that the level of trust in transformational changes by economic agents is one of the most important parameters for forecasting the behavior of the market, and, consequently, the functioning of the transformational economy as a whole. Market expectations in the course of the transformation cycle should be in line with the second scenario of the model, that is, the growth of completed economic transformations in resort and tourist companies. In

this case, there is a significant increase in free capital in this market, which leads to an increase in demand for resort and recreational products.

References

1. Bokov, M.: Strategic management of recreational enterprises in conditions of transitional economy. National Institute for Strategic Studies, Kyiv (2011)
2. Amirkhanov, M., Tatarinov, A.: Economic problems of development of recreation regions. Helios, Kyiv (2017)
3. William, A.: Recreation and the Local Economy an Input-Output Model of a Recreation-Oriented Economy. Graduate School of Business University of Wisconsin-Madison (2012)
4. Inskip, E.: National and Regional Tourism Planning: Methodologies and Case Studies. Polact, New York (2014)
5. Shekhovtseva, A.: Competitiveness of the region: the factors and method of creating. Marketing in Russia and abroad. 4, 11–15 (2010)
6. Galasyuk, S.: Analysis of level of competitiveness of regional market of tourist services. Bull. Khmel'nitsk National University. 2, 89–93 (2010)
7. Malinetskii, G.: Mathematical Foundations of Synergetics: Chaos, structures, computational experiment. URSS, Moscow (2015)
8. Mikulsky, K.: Problem of transformation and transition to a regular market economy. Economic, Moscow (2012)
9. Keynes, D.M.: The General Theory of Employment, Interest and Money. Palgrave Macmillan, London (2007)
10. Hicks, J.: Automatists, Hawtreys and Keynesians. Journal of Money Credit and Banking. 2, 311–323 (2009)
11. Muth, J.: Rational Expectations and the Theory of Price Movements. Journal of Econometric. 29, 315–335 (2011)
12. Lucas, R., Sargent, J.: Rational Expectations and Econometric Practice. Allen & Unwind, London (2011)
13. Hodgson, G.M.: Economics and Institutions: A Manifesto for a Modern Institutional Economics. Polite Press, Cambridge (1988)
14. Dovbenko, M., Osyk, Yu.: Modern economic theories in the works of Nobelians. National Institute for Strategic Studies, Kyiv (2011)
15. Seligman, A.B.: The Problem of the Trust. Princeton University Press, Princeton (2000)
16. Stiglitz, J.E.: The Roaring Nineties: Seeds of Destruction. Allen Lane, London (2013)
17. Sangnier, M.: Does trust favor macroeconomic stability. Journal of Comparative Economic. 41(3), 653–668 (2013)
18. Nunkoo, R., Ramkissoon, H., Gursoy, D.: Public trust in tourism institutions. Journal of Annals of Tourism Research. 39(3), 1542–1544 (2012)
19. Khoskynh, D.: Economy of trust. Nedotorkannyj zapas. 5, 21–29 (2017)
20. Zakharchenko, P., Kostenko, A., Kungurtseva-Mashchenko, T., Gorbachova, I.: Modeling expectations of resort-tourist market of Ukraine. SHS Web of Conferences. 65, 05001 (2019). doi: 10.1051/shsconf/20196505001

The Price Competition Simulation at the Blended Trading Market

Oleg Pursky^[0000-0002-1230-0305], Tatiana Dubovyk^[0000-0001-9223-4629],
Iryna Moroz^[0000-0003-3689-6235], Iryna Buchatska^[0000-0003-2413-7370] and Anastasiia Savchuk

Kyiv National University of Trade and Economics, 19, Kyoto Str., Kyiv, 02156, Ukraine
Pursky_O@ukr.net, tatiana_dubovik@i.ua, iomoroz200@gmail.com,
ira_buchatska@ukr.net, tatianavdubovik@gmail.com

Abstract. In the present work, an attempt has been made to apply economic and mathematical methods for the simulation of electronic trading market operation based on price competition between e-trade companies and traditional trade enterprises. The developed price competition model based on the concept of symmetric product differentiation. The results obtained in the present investigation demonstrate that in a mixed strategy, firms sell products at different prices, depending on the price strategy or the volume release strategy. The company that sets the volume, sells more, but at a lower price than its competitor which sets prices. The influence of strategic output exceeds price influence. Thus, the company that sets prices, falls into an unfavorable situation and receives lower profits compared with its competitor with the strategy for the volume of production. The company that has decided to introduce electronic trading technology initially will bear losses.

Keywords: price competition, e-trade, oligopolistic market, price and production volume strategy.

1 Introduction

Modern world economic conditions, economy globalization, acceleration of market development processes, information technologies, sociopolitical factors demand from the trading enterprises new approaches to consumer demand and supply formation, the development of adequate methodological solutions and tools in the field of management of the trade activity, especially it concerns new forms of trading, such as e-trade [1]. Companies today are working in a turbulent environment facing continuous change because of hyper-competition, changing demands of customers, regulatory changes and technological advancement [2].

E-trade, as compared to traditional business, has substantial advantages. In particular, the use of new electronic communication channels significantly reduces costs related to organization and support business infrastructure, and the possibilities of e-commerce allow re-designing business strategy at any moment. The functions of modern e-trade market mechanisms are not limited by a small number of fields, such as, for example, automated reservation systems in tourism, financial sector operations

and electronic supermarkets in the retail sector, the range of today's e-trade markets is far larger according to the range of applications. New products and services and innovative trade mechanisms have appeared on e-trade markets: communications that facilitate news outsourcing, ratings, forecasts, services and the implementation of innovative ideas have been developed. As a result, e-trade has become a very profitable form of relationship with the buyer who is developing, not seeking to replace it with other forms of trade contacts and connections. Economic properties and peculiarities that have emerged in the process of becoming e-trade have not only provided it with the possibility of a competitive global existence in the world of modern global business, but also created the prerequisites for quite optimistic forecasts of its future [3].

New features of computer and information technology affect both the production and distribution of goods and services. E-trade allows firms and companies to sell their products without the use of traditional sales channels [4]. The use of electronic trading changes both the production process and the sales process in two main directions [5, 6]:

1. electronic trading reduces the time between production and sales, as flexible technologies allow firms to create goods and services in accordance with their demand;
2. restrictions on production are decreasing, as new technologies allow for almost unlimited duplication of informational products with extremely low costs.

Effective management of e-trade development, as well as the processes of the economy informatization as a whole, is impossible without a full and comprehensive economic and mathematical research of the whole complex of problems, including, on the one hand, the activities of enterprises in the field of electronic commerce, and, on the other, the use of information technology in enterprises and organizations of all branches of economy [7-9]. Due to the wider introduction of electronic trading technologies, the scientific development of methods of applying economic and mathematical methods in the research of the state and prospects of electronic trading development has significantly intensified and, most importantly, has increased their demand for practical work. The application of economic and mathematical methods to solve many specific problems can increase the efficiency of economic entities that actively use electronic trading in their activities. In general, we are talking about a toolkit developing that can be used to analyze the complexities of e-commerce, and which will be the basis for developing effective mechanisms for effective governance and decision-making [10-14].

In the presented research, an attempt has been made to apply economic and mathematical methods for the model development of electronic trading market operation based on price competition mechanisms between electronic trading actors. Suppliers who have already adopted electronic technology, act as competitors for the price, because they may not link themselves with the volume of output. Other firms that continue to use the usual technology of production and sales should increase or decrease their production capacity before starting production. Thus, they compete in terms of output. Considering the various reasons for competition in price and quantity while moving towards the electronic trading and trading firms set of strategies in the

oligopolistic market, it is worth mentioning the following provisions. A trading company can choose a strategy for output, if it needs to make a managerial decision on the volume of production before or after the production commencement, in which case the company must make irreversible investments. The price strategy and the product-oriented strategy can be interpreted as extreme cases of an elastic or inelastic output function and depend on the different angles of inclination of the marginal cost function [15]. While the extremely low costs lead to price strategies, product launch strategies meet the high marginal costs associated with inflexible technologies.

2 Results and Discussion

2.1 Model

Prices play an essential role in any market and understanding how they are fixed is a fundamental part of the Economic Science. However, complex problems such as social networks or the launching of new digital platforms can set new challenges in understanding how those prices are fixed [16].

Oligopolistic markets are known to be associated with a high degree of price and output rigidity. This is due to mutual interdependencies among firms in the market with regard to price and production [17]. An oligopoly represents a market where power is concentrated among a small number of firms. The exact number of firms is not important; what matters is that a few firms produce most of the market's output. The barriers to entry for an oligopolistic market are high as a result of the scale of the incumbent firms and the competitive advantages that are derived from that scale. Moreover, unlike perfect competition, monopoly, and monopolistic competition, it is most useful to study an oligopoly in terms of the interdependence and rivalry among its firms. Given that the primary characteristic of any oligopoly is the interdependence and rivalry among its firms, any firm in an oligopoly that ignores the critical nature of its interdependence with its competition places its share of the market and its capacity for profits at risk [17].

Let us consider a market in which part of firms moved to e-trading technology, while others use traditional, that is, there is a market with firms competing for the price and volume of manufactured products. As a base one we apply the concept of symmetric differentiation of goods [18]. In the assumption of profit maximization [19], we will construct the general curves of responding firms that choose a pricing strategy or a strategy focused on the issue for determining the equilibrium, and consider the impact of switching to e-trading to choose a strategy firm, in particular: how the change of technology will affect the own production of the company, its competitors, market efficiency and investment.

Let's construct a model that uses the concept of symmetric product differentiation. In this case, N - is the number of firms using linearhomogeneous technology that creates individual and constant C_i - expences - for the production of a limited variety of symmetrically differentiated product x_i , that is sold at a price p_i . The functions of demand for products of the company are the typical consumer with linear quadratic utility [20]:

$$u(x_1, \dots, x_N) = \sum_{i=1}^N x_i - \frac{1}{2} \left(\sum_{i=1}^N x_i^2 + b \sum_{i=1}^N \sum_{i \neq j} x_i x_j \right) - \sum_{i=1}^N p_i x_i \quad (1)$$

where the inverse functions of demand:

$$p_i = 1 - x_i - b \sum_{i \neq j} x_j \quad (2)$$

Parametric variable b evaluates the degree of substitution between any two products. If $b=1$, the products are complete counterparts, while all firms make different products if $b=0$. We assume that n is the number of firms ($i=1, \dots, n$) that follow the strategies in terms of production volume, that is specify the volume of output, while $\{N-n\}$ is the number of firms ($i=n+1, \dots, N$) that follow the pricing strategy. The distribution of external and internal prices and volumes of output, leads to such demand for the company j , which sets the volume of production, and the company k , which sets the price, respectively:

$$p_j = 1 - b \sum_{i=1, i \neq j}^n x_i - b \sum_{i=n+1}^N x_i - x_j = 1 - b \sum_{i=1}^n x_i - b \sum_{i=n+1}^N x_i - (1-b)x_j \quad (3)$$

$$p_k = 1 - b \sum_{i=1}^n x_i - b \sum_{i=n+1, i \neq k}^N x_i - x_k = 1 - b \sum_{i=1}^n x_i - b \sum_{i=n+1}^N x_i - (1-b)x_k \quad (4)$$

From the equation (4), we obtain the direct demand function for production:

$$x_k = \frac{1 - b \sum_{i=1}^n x_i - b \sum_{i=n+1}^N x_i - p_k}{1 - b} \quad (5)$$

By summing up the $(N-n)$ demand function of firms that use price strategies and making the corresponding transformations, we obtain the total output of products made by firms which set the price:

$$\sum_{i=n+1}^N x_i = \frac{(N-n) \left(1 - b \sum_{i=1}^n x_i \right) - \sum_{i=n+1}^N p_i}{1 + b(N-n-1)} \quad (6)$$

Substituting the formula (6) into the equations (3) and (5) and marking the choice of price $\sum_{i=1+n}^N p_i$ and output volume $\sum_{i=1}^n x_i$ through R and X , respectively, we obtain the functions of demand in this form:

$$p_j = \frac{1-b}{1+b(N-n-1)} - (1-b)x_j - \frac{b(1-b)X}{1+b(N-n-1)} + \frac{bP}{1+b(N-n-1)} \quad (7)$$

$$x_k = \frac{1}{1+b(N-n-1)} - \frac{p_k}{1-b} - \frac{bX}{1+b(N-n-1)} + \frac{bP}{(1+b(N-n-1))(1-b)} \quad (8)$$

Thus we obtained a system of two equations that can be solved on the basis of balance state conditions [20, 21]. The market activity of firms j with strategy on the volume of production, so firms k with the pricing strategy designed to maximize profits Pr [20]:

$$\max Pr_j(x_j, P, X) = p_j(x_j, P, X) - C_j x_j \quad (9)$$

$$\max Pr_k(p_k, P, X) = p_k x_k(p_k, P, X) - C_k x_k(p_k, P, X) \quad (10)$$

That is, the company j is looking for the opportunity to maximize its own profits by choosing the volume of output x_j , taking for it the total output of products manufactured by competitors ($X-x_j$). While company k determines the influence of the decision on its own price on aggregate P , assuming instead of it the established X and the established aggregate prices of competitors ($P-p_k$).

Solving the equations (7) and (8), the substitution function [22] $\mu_i(X, P)$ for company j and for company k will look like:

$$x_j = \mu_j(X, P) = \frac{1-b-b(1-b)X+bP-(1-b+b(N-n))C_j}{(1-b)(2-b+2b(N-n))} \quad (11)$$

$$p_k = \mu_k(X, P) = \frac{1-b-b(1-b)X+bP-(1-2b+b(N-n))C_k}{2-3b+2b(N-n)} \quad (12)$$

Unlike the reaction function, μ_i does not describe the optimal response of the market participant (x_i, p_i) to the strategic choice of its competitor (that is $X-x_j$ or $P-p_k$, respectively), but describes the reaction to the total X or P , which include its own strategic level.

Using the fact that in the [23] the general reaction corresponds to the aggregate strategic choice, herewith $\sum_{i=1}^n \mu_i(X, P) = X$, and $\sum_{i=n+1}^N \mu_k(X, P) = P$, we can find a strategic issue and a total strategic price:

$$X = \frac{(1-b)n+bnP-(1-b+b(N-n))\sum_{i=1}^n C_j}{(1-b)(2-b+b(2N-n))} \quad (13)$$

$$P = \frac{(1-b)(N-n)(1-bX)}{2-3b+b(N-n)} + \frac{(1-2b+b(N-n))\sum_{i=n+1}^N C_k}{2-3b+b(N-n)} \quad (14)$$

2.2 Simulation

The decision on the total output of products X depends on aggregate prices and turnover. Accordingly, equations (13) and (14) can be regarded as collective reaction functions. Figure 1 shows the calculated by the formulas (13) and (14), depending on the reaction of firms that set the price and volume of output. It should be noted that in order to describe the mechanisms of the e-trade markets operation, in this case, the calculations are performed by dividing all market participants into the corresponding number of market participants with a start-up on the production volume and price strategy. Thick (black) lines describe the behavior of market participants with two firms with a strategy on the production volume and three firms with a pricing strategy at zero marginal costs and $b=0.5$.

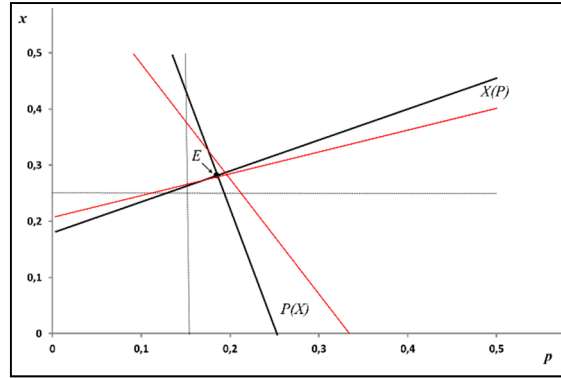

Fig. 1. Dependence of the market participants general reaction with different trading strategies.

The intersection of the lines (point E), in our case, indicates a mixed equilibrium. Thin (red) lines indicate the behavior of market participants $n=3$ and $N-n=2$. Dotted lines on the graph show the results for firms with market participants with the same strategies, they are designed for comparison with mixed strategies. Figure 1 illustrates the relationship between the strategic aggregate price and aggregate issue: if prices rise, then the firms, which set prices, implement a less aggressive strategy, and market participants with a strategy for the volume of production will react to an increase in output. As X grows in P , it becomes a strategic complement to the aggregate price of P . On the other hand, the firms, which set prices, will lower their prices if the firms, which set the output, act more aggressively. Consequently, the firms' prices with price strategy is a strategic supplement to the cumulative output X .

For the system of equations (13) and (14) there is an appropriate analytical solution. It is seen that both of the response functions are linear with respect to P i X , that is, there is a single solution of this system of equations:

$$P^* = \frac{1}{(1-b)z} \left((N-n)(1-b)(2-b+2b(N-n)) + \alpha \sum_{i=1}^n C_i + \beta \sum_{i=n+1}^N C_i \right) \quad (15)$$

$$X^* = \frac{1}{(1-b)z} \left(n(1-b)(2+b(2N-2n-1)) + \gamma \sum_{i=1}^n C_i + \delta \sum_{i=n+1}^N C_i \right) \quad (16)$$

where

$$\begin{aligned} z &= (1-b)(4+b(6N-4n-4)) + b^2(2N(N-n)-N-1), \\ \alpha &= b(N-n) + b^2(N-n-1), \\ \beta &= (1-b)(2+b(4n-3n-3)) + b^2((2N-n)(N-n)-(N+1)), \\ \gamma &= (1-b)(2+3b(N-n-1)) + b^2((N-n)^2-(N-n)), \\ \delta &= bn + b^2(N-n-2). \end{aligned}$$

Values α , β , δ , γ , and z are positive for any $n < N$, $n \in N$, and $0 < b < 1$.

Substituting (15) and (16) in (11) and (12), we obtain the balance state [23, 24] of the price and output for company j , which uses the strategy for the volume of output, and the company k , which sets prices:

$$\begin{aligned} x_j &= \frac{(1-b) \left[4 + 8b(N-n-1) + b^2(2(N-n)-1)(2(N-n)-3) \right]}{z(1-b)(2-b+2b(N-n))} \\ &+ \frac{\varepsilon \sum_{i=1}^n C_i + (\varepsilon - b^3) \sum_{i=n+1}^N C_i - \eta C_j}{z(1-b)(2-b+2b(N-n))} \end{aligned} \quad (17)$$

$$\begin{aligned} p_j - C_j &= \frac{(1+b(N-n)(1-b)) \left[4 + 8b(N-n-1) + b^2(2(N-n)-1)(2(N-n)-3) \right]}{z(1+b)(N-n-1)(2-b+2b(N-n))} \\ &+ \frac{(1+b(N-n)) \left[\varepsilon \sum_{i=1}^n C_i + (\varepsilon - b^3) \sum_{i=n+1}^N C_i - \eta C_j \right]}{z(1+b)(N-n-1)(2-b+2b(N-n))} \end{aligned} \quad (18)$$

$$\begin{aligned} x_k &= \frac{(1-b) \left[4 + 8b(N-n-1) + b^2(2(N-n)-1)(2(N-n)-3) \right]}{z(2-3b+2b(N-n))} \\ &+ \frac{\varepsilon \sum_{i=1}^n C_i + (\varepsilon - b^3) \sum_{i=n+1}^N C_i - \eta C_k}{z(1-b)(2-b+2b(N-n))} \end{aligned} \quad (19)$$

$$\begin{aligned} p_k - C_k &= \frac{(1+b(N-n-2)(1-b)) \left[4 + 8b(N-n-1) + b^2(2(N-n)-1)(2(N-n)-3) \right]}{z(1-b)(1+b(N-n-1))(2-3b+2b(N-n))} \\ &+ \frac{(1+b(N-n-2)) \left[\varepsilon \sum_{i=1}^n C_i + (\varepsilon - b^3) \sum_{i=n+1}^N C_i - \eta C_k \right]}{z(1-b)(1+b(N-n-1))(2-3b+2b(N-n))} \end{aligned} \quad (20)$$

where $\varepsilon = (1-b)[2b + b^2(4N-4n-3)] + b^3[2(N-n)^2 - (N-n)]$,
 $\eta = (1-b)[4 + b(10N-8n-8) + b^2(4(2N-n)(N-n) - 8(N-n) - 3(N-1))] - b^3[N(2N-n)^2 - (N-n) - (N-n)]$. The coefficients ε and η are positive for all admissible N , n , and b .

The analysis of the formulas (17-20) shows that the output and increase in production costs will decrease, with the increase in the number of companies in the market (see increase z). The increase in the cost of firm's own production has the same effect, while the rising costs of competitors lead to the opposite: the own increase and the issue in this case are increasing.

Using the obtained results, we can approach to the research of the strategic impact of electronic trading on market functioning. The use of economic and mathematical methods to describe the mechanisms of development and electronic trading markets operation is based on the point of view that the main factors and trends of past periods persist and during the periods of development of the investigated area of economic activity, that is, there is a possibility to reasonably take into account the direction of future changes not only qualitatively but quantitatively.

The e-trading markets operation is implemented in accordance with the laws of a market economy, so when attempting to assess the future reaction of market participants to one or another process that occurs within the framework of the electronic trading markets operation, causal relationships should be considered in the form of rules, regularities and generally accepted mechanisms of decision-making in the processes of market operation. It is clear that in this case there is a certain inertia of social and economic systems.

To simplify the analysis, assume that production has no expenses, regardless of which technology is used, that is: $C_j=C_k=0$. Thus, any impact of costs associated with other technologies is ignored. In fact, technological innovation can change the structure of the company's costs, but reducing costs by changing technology is not the goal of this study.

Consider the market situation of the market participant with the strategy for the volume of production and compare it with the position of the company using electronic trading technology, and act as a company that sets the price.

The question arises: which of the firms setting the price or volume of output, appears in a profitable strategic situation. First of all, we will analyze the consequences of technological changes, that is, the transformation of the company into a strategy for the volume of issue in the market participant with the price strategy, in particular, determine whether it is profitable to introduce electronic trading technology from the company from a strategic point of view? Thus, the company must take into account the impact of its own technological innovation on market participants. After technological changes, there is in one traditional supplier less on the market, but another company is added to the electronic trading market.

In a mixed strategy [25], market prices set by market participants with a price strategy are higher than the prices of market participants with a strategy for output at equal low (zero) marginal costs. Figure 2 shows the difference in the demand of two types of market participants.

Analytical calculations presented in Figure 2, was made on the basis of formulas (17-20); in the calculations, the emphasis is was made on the company's transition from traditional technology to the price strategy with electronic trading technology. In addition, the number of companies with a strategy for the production volume contains one less market participant, compared with competing firms which set prices. For this

reason, the demand function is more elastic for companies with a strategy for volume output. If this company acts more aggressively, it can capture all the demand from the firm, moving to electronic trading with the price strategy. As a result, the marginal profit from lowering the price will be higher for companies with a strategy for output, and they will sell products at lower prices rather than their competitors with the price strategy. For confirming this conclusion, let us find the relation between equations (20) and (18) with the same marginal cost $C_j=C_k=0$, which shows the relationship between the prices of goods of two firms operating on the market with different trading strategies:

$$\frac{p_k}{p_j} = \frac{(1+b(N-n-1))(2-b+2b(N-n))}{(1+b(N-n))(2-3b+2b(N-n))} \quad (21)$$

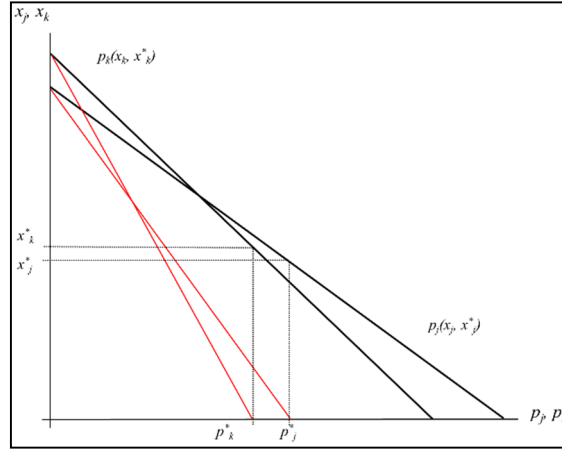

Fig. 2. Differences in demand between company j , which uses the strategy for the volume of production, and company k with the price strategy.

The right-hand side of the ratio has the form $(AB-b)/(AB-2Ab)$, where $A=1+b(N-n)$, $B=2-b+2b(N-n)$, $b>0$. The numerator exceeds the denominator, since $B<2A$. Hence $p_k>p_j$, that is, market participants with a strategy for the release sell products at lower prices than firms with a price strategy.

Now compare the marginal revenue of firms with market participants with different strategies. Using equations (9), (10), (21) and arguments of equations (17-20) we obtain:

$$Pr_j = \frac{(1-b)(1+b(N-n))}{(1+b(N-n-1))} x_j^2 \quad (22)$$

$$Pr_k = \frac{(1+b)(N-n-2)}{(1-b)(1+b(N-n-1))} (p_k - c_k)^2 \quad (23)$$

$$\frac{Pr_k}{Pr_j} = \frac{(1+b(N-n-2))(2-b+2b(N-n))^2}{(1+b(N-n))(2-3b+2b(N-n))^2} \quad (24)$$

The ratio (24) has the form: $((A-2b)B^2)/(A(B-2b))^2$. These data indicate that the denominator is greater than the numerator, if $2Ab-B(2A-B)>0$. This condition is always satisfied with positive A , B , and b , since $B<2A$ and $2A-B=b$. Thus, market participants with a strategy focused on the volume of production receive more profit compared with firms with the price strategy: $Pr_j>Pr_k$.

The conducted study of the e-trading market operation leads to the following results:

1. In a mixed strategy, firms sell products at different prices, depending on the price strategy or the production volume strategy. The company that sets the production volume sells more, but at a lower price than its competitor which sets prices;
2. While analyzing the enterprise economic activity it is necessary to take into account that the strategic output influence exceeds the pricing influence. Thus, the company that sets prices falls into an unfavorable situation and receives lower profits compared to its competitor with the strategy for the volume of production.

It is also worth mentioning that the company with a price strategy receives lower profits, but sets higher prices than a competitor with a strategy for the volume of production, so its volume of sales is lower.

3 Conclusion

On the basis of results obtained in the present investigation it seems justified to conclude that firm, which has decided to introduce an e-trade technology it will initially incur losses. It is necessary to consider that changing their own technologies affect the overall market structure: number of firms, which set prices, increases to $(N-n+1)$, at a time when the number of firms with a production volume strategy in the market is reduced to $(n-1)$. However, the influence of strategy changes on other companies that set prices and on the operation of e-trading market as a whole is not entirely clear, the result of close substitutes ($b>2/3$), at the same time, sales of competitors with the production volume strategy in this case are being reduced. Through a feedback effect of enhanced aggressiveness of firms which set the prices – there is a significant impact on the participants, which establish the production volume. The decline of the number n may even lead to higher profits of firms with pricing strategy, while firms with a production volume strategy will receive less income. This raises the question – do consumers benefit from the introduction of electronic trade? At least this model gives a positive answer on this question.

General decline in prices caused by changes in technology of trading, loosening the restraints of a typical consumer's budget. In this regard, real consumer welfare increases. While the firms that implemented e-trade technology, get a strategically disadvantageous situation, consumers will benefit from the introduction of the new

electronic production and marketing. In such a situation, market efficiency increases whereas the price of allowances at zero marginal costs decrease.

Further research should endeavour to a complete and comprehensive economic and mathematical research of the whole complex of problems, including, on the one hand, the activities of enterprises in the field of e-trade, and, on the other, the use of information technology in these enterprises and organizations. In general, we are talking about a toolkit developing that can be used to analyze the complexities of e-trade, and which will be the basis for developing mechanisms for effective governance and decision-making at the e-trade enterprises level.

4 Acknowledgements

This study was supported by the Ukrainian Ministry of Education and Science, Project No. 0117U000507, “Modeling the mechanisms of international e-commerce operation”.

References

1. Belew, S., Elad, J.: *Starting an Online Business All-in-One for Dummies*. 3rd edn. For Dummies, New Jersey (2017)
2. Raman, A., Bharadwaj S., Mukherjee, J.: Developing SOA-enabled service agility capabilities: case studies in services industry. *Int. J. Business Information Systems*. **27**(1), 21–44 (2018)
3. Pursky, O.I., Grynyuk, B.V., Shestopal, D.A.: Planning of advertising costs and vendor number at e-trade market. *Actual Problems of Economics*. **177**(3), 407–413 (2016)
4. Schneider, G.: *Electronic Commerce*. 12th edn. Cengage Learning, Boston (2016)
5. Laudon, K.C., Traver, C.G.: *E-commerce: Business, Technology, Society*. 8th edn. Pearson, Boston (2012)
6. Chaffey, D.: *E-business and E-commerce Management*. 5th edn. Prentice Hall/Financial Times, New Jersey (2011)
7. Wiśniewski, J.W.: *Correlation and Regression of Economic Qualitative Features*. Lambert Academic Publishing, Saarbrücken (2013)
8. Rima, I.H.: *Development of Economic Analysis*. 6th edn. Routledge, Abingdon-on-Thames (2000)
9. Choo, E., Shum, M.: *Structural Econometric Models (Advances in Econometrics)*. Emerald Group Publishing Limited, Bingley, West Yorkshire (2013)
10. Cerreia-Vioglio, S., Marinacci, M., Vigna, E.: *Principles of Mathematics for Economics*. 1st edn. Springer, Heidelberg (2019)
11. Bloxham, E.: *Economic Value Management: Applications and Techniques*. 1st edn. Wiley, Hoboken, New Jersey (2002)
12. Bergstrom, A.R.: *The Construction and Use of Economic Models*. 1st edn. English Universities Press, London (1967)
13. Basu, D.R.: *Economic Models: Methods, Theory and Applications*. World Scientific Publishing Company, Singapore (2009)
14. Davis, J.B., Hands, D.W., Maki, U.: *The Handbook of Economic Methodology*. Edward Elgar Publishing, Camberley (1998)

15. Jehle, G.A., Reny, P.J.: *Advanced Microeconomic Theory*. 3rd edn. Pearson Education Limited, Edinburgh Gate, Harlow, Essex (2011)
16. Sanchez-Cartas, J.M.: Agent-based models and industrial organization theory. A price-competition algorithm for agent-based models based on Game Theory. *Complex Adapt. Syst. Model.* **6**(2), 1–30 (2018)
17. Rosenberg, S., O'Halloran, P.: Firm behavior in oligopolistic markets: Evidence from a business simulation game. *Journal of Business Case Studies.* **10**(3), 239–254 (2014)
18. Thomson, S.B.: *Symmetric Properties of Real Functions*. 1st edn. CRC Press, Boca Raton (1994)
19. Nash, J.F.: Noncooperative games. *Annals of Mathematics.* **54**(2), 286–295 (1951)
20. Becker, G.S.: *Economic Theory*. 2nd edn. Transaction Publishers, Piscataway, New Jersey (2007)
21. Von Stackelberg, H.: *Market Structure and Equilibrium*. Springer-Verlag, Heidelberg (2011)
22. Tirole, J.: *The Theory of Industrial Organization*. 1st edn. The MIT Press, Cambridge (1988)
23. Abramovich, Y., Dillmann, R.: *Functional Analysis and Economic Theory*. 1st edn. Springer-Verlag, Heidelberg (2012)
24. Bjonnes, R.: *Principles for a Balanced Economy: An Introduction to the Progressive Utilization Theory*. Prout Research Institute, Caracas (2012)
25. Siegel, D.: *Futurize Your Enterprise: Business Strategy in the Age of the E-customer*. 1st edn. Wiley, Hoboken (1999)
26. Pursky, O., Dubovyk, T., Moroz, I., Buchatska I., Savchuk, A.: The price competition simulation at the trading market in the presence of electronic and traditional trade. *SHS Web of Conferences.* **65**, 04001 (2019). doi: 10.1051/shsconf/20196504001

Assessment of the Economy Structural Changes Based on the Consistency

Oksana Kovtun

Cherkasy Education Center of Old Polish University in Kielce, Cherkasy, 18000, Ukraine
kovtun.oa71@gmail.com

Alla Opalenko^[0000-0001-8783-2149]

Cherkasy State Technological University, 460, Shevchenko Blvd., Cherkasy, 18000, Ukraine
seyalla@ukr.net

Oksana Ivanylova

University of Educational Management, 52A, Sichovykh Striltsiv Str., Kyiv, 02000, Ukraine
oksi_iv@i.ua

Abstract. This article deals with the assessment of the structural changes of the national economy of Ukraine, which proposed to implement by applying the integrated index of structural changes, assessment of the structural changes of the sectoral structure of GDP, at determining the weighting coefficients and construction which uses the “golden ratio” rule. This approach is based on the theoretical completion of the economics as for the progressive development and transformation of society and the economy of the country according to the technological criterion, as well as the sectoral division of the national economy. The choice of components of the integrated index for structural changes is due to the sectoral division of GDP into industry, agriculture and services, and further distribution according to the sectoral structure of the national economy. The proposed integrated index reflects the consistent (ideal) GDP structure inherent in the post-industrial economy, while the deviation of the values in the real structure shows structural changes in the national economy of Ukraine and 28 countries of the European Union. The research justifies the weighting coefficients for the selected sectors of the economy, depending on the technological complexity of the process of producing goods (works, services). The article deals with the results of the calculation of the integrated index of the structural changes in the sectoral structure of GDP and its structural elements, as well as the analysis of the reasons for the deviations of real indicators from the consistent ones. The calculations show the crisis phenomena in both the Ukrainian economy and the EU countries, which are explained by the debt crisis in the EU in 2013 and the release of the UK with the EU. The domestic economy shows significant deviations in virtually all sectors, indicating a low level of economy, a non-conformity between supply and demand in the labor market, a low level of innovation, and the inertia of transformational processes in the transition to the post-industrial stage of production. The application of the proposed methodology

will allow us to identify strategic directions for the development of sectors of the national economy and develop projection scenarios

Keywords: structural changes, integrated index, assessment, consistent structure, postindustrial economy, sector of national economy, the “golden ratio” rule.

1 Introduction

In the conditions of post-industrial economy, globalization transformations and informatization of society, there is a significant change, firstly, of the nature of labor, where intellectualization and the ability to work with large volumes of information are at the top, and secondly, the division of production activity by the sectoral principle being the basis for the new intellectual and creative sector, and thirdly - the change of the vector of satisfaction of material needs to the cultural and personal [1], and hence the change of the person's motivational complex [2]. As a result of these processes, structural changes in the economy are observed, which in turn requires the development and implementation of a methodology for evaluating structural changes in order to reduce their negative impact, developing scenarios for the development of the national economy and the satisfaction its needs by highly qualified specialists. On that basis, it became necessary to realize this research.

The terms “structure” and “structural changes” are widely used in the economics of foreign and domestic scholars, although they give them different definitions and interpretations. In researches on economic development and economic history, structural changes (changes) are usually understood as “... mechanisms of production activity in the national economy and the distribution of the inputs between sectors of the economy, professions, geographic regions, product types, etc. ...” [3, p. 76].

The concept of structural changes directly relates to the definition of models for the development of the national economy, one of which is sectoral, it reflects the progressive development and transformation of society and economy according to the technological criterion. By the definition of A. Chuhno specified model is based on the separation of sectors of the economy and the establishment of regularities in changing the structural relations between them, and the prevailing role of a particular sector at a particular stage of socio-economic development [4, p. 73-83].

Proceeding from the postulates of the theory of post-industrial society, each of the sectors of public production dominates at a particular stage. According to A. Chuhno, “In the post-industrial society, the sphere of services is dominant, and industry and agriculture (material production), while preserving and even increasing production volumes, occupy an entirely ratio” [4, p. 83]. According to L. Sergeeva, any structure is an inertial component of complex socio-economic systems, which is also economic, it determines the scenarios of its development in the long-term perspective and allows to create strategic directions of its development [5].

A lot of works are devoted to the analysis of structural changes in the economy, in particular, in the work of S. Kuznets, the redistribution of capital from agriculture to industry, and then to the sphere of services is investigated. He recognizes the

productivity and profitability of capital and labor [6]. Structural changes and their consequences, as well as prospects for the development of the national economy, are researched in the works of foreign authors – V. Inozemtceva [2], S. Glazieva [7], and Ukrainian authors, namely – V. Heiets [8], A. Chuhno [4], L. Sergeeva [5], O. Kuzmin [9], O. Pyroh [10], I. Pasinovych [11].

The bulk of the researchers relies on statements about the relationship between technological change and structural changes. In the article I. Pasinovych examines the cycle of structural development of the Ukrainian economy and substantiates the existence of structural changes as a mandatory stage, defines them as a change in the proportions of the structure arising as a result of the accumulation of structural changes [11, p. 83]. A. Kramarenko proves that there is a correlation of technological and economic development, as evidenced by the development of civilization is the UK economic system based on scientific and technological progress and definition of driving and leading industries. The author argues that after analyzing the tendency and changes in the economic structure, it is possible to predict the directions of further progressive development of national economies [12]. N. Pogorzelskaia concluded that the sustainable development of socio-economic systems is determined by the tendencies of structural transformations of the economy under the influence of technical and technological potential, as well as the correlation between the genesis of technological patterns and patterns of structural development, taking into account the shallow water theory [13].

Sufficient attention in the scientific developments of domestic researchers is devoted to the analysis of structural changes in certain industries of the economy, namely: O. Kyrychenko, on the basis of analysis of world trends of industrial structural changes, concludes that their main directions are connected with the development of high-tech industries, the latest telecommunication technologies and expansion assortment of services for business and society [14, p. 30]; the authors' research is devoted to the problem of structural transformation of employment in Ukraine in the areas of economic activity [15], it revealed significant negative deviations in the structure of employment from the EU, which is explained by the backwardness of the domestic economy by technological indicators and ineffective state policy. In the article of H. Miliutin it was found that the structural changes in energy and electricity generation in Ukraine in 2000-2016 were low, with the most structural changes in power and electricity output for the analyzed period occurred in renewable energy sources, and a significant negative structural change is in the production of electricity at thermal power plants, which is explained by outdated and power generation technologies [16].

In relation to the research of the sectoral model of the development of the national economy in conditions of a post-industrial society, we should highlight the work of O. Kuzmin and O. Pyroh. They proposed an economic and mathematical model that takes into account the structural and technological requirements of the post-industrial stage of the development of the world economy, as well as predicted a sectoral model of the development of the national economy for the long-term period to achieve the level of development of the EU-27 and Poland, according to which Ukraine should increase the ratio of quaternary and quinary sectors in reducing the primary and tertiary sectors [9].

Consequently, structural changes mean changes in the sizes of the sectors of the national economy, as evidenced by such macroeconomic indicators as the structure of GDP and employment, the level of technological productivity of the industry (the percentage of high-tech, medium and low technological production), innovation of the economy, etc.

However, despite such a powerful array of scientific achievements in this regard, significant gaps in our opinion, is the lack of modern techniques of reasonable assessment of structural changes in the national economy in that sectors that will allow Ukraine in the future to move to a higher level of technological complexity and to solve the problem of forming the labor market structure that corresponds to the post-industrial stage of the national economy.

2 Research Methodology

The methodological basis for the assessment of the structural changes in the national economy of Ukraine is based on the rules of mathematical consistency, namely the “golden ratio”, which allows to determine the “ideal” structure and calculate its deviations. Such an approach is proposed by a team of authors [17] and L. Sergeeva [5]. They indicate that deviations from the consistent structure lead to the emergence of specific structural risks and crisis phenomena. The author [5] determined by the consistent structure of the economy, which characterized the post-industrial stage, in the following proportion: services sector (which dominates in the structure) – 62 %, industrial sector – 24 %, agriculture – 14 %, which determined the basic coefficients in the integrated index of the assessment of the changes in the sectoral structure of GDP by the three-sector model.

In the formalized form, according to the classical approaches of the theory of post-industrial society and the “golden ratio” rules, it has next form:

$$S_{GDP} = |0,62 - S_{Serv}| + |0,24 - S_{Ind}| + |0,14 - S_{Agr}|, \quad (1)$$

S_{GDP} – valuation of integrated index ($0 < S_{GDP} < 1$);

S_{Serv} – share of service sector in GDP;

S_{Ind} – share of industry in GDP;

S_{Agr} – share of agricultural industry in GDP.

But, given the current state and trends in the development of world and national economies, scientists also distinguish a five-sector model [4, 8-10]. Therefore the detailed structure of the integrated index based on the technological complexity and intensity of production, using the rules of the “golden ratio” is proposed:

$$S_{GDP} = |0.24 - S_{4,1}| + |0.14 - (S_{4,2} + S_{4,3})| + |0.15 - (S_{5,1} + S_{5,2} + S_{5,3} + S_{5,4})| + |0.09 - (S_{5,5} + S_{5,6} + S_{5,7} + S_{5,8})| + |0.15 - S_2| + |0.09 - S_3| + |0.09 - S_{1,1}| + |0.05 - S_{1,2}| \quad (2)$$

where S_{GDP} value of integral index ($0 < S_{GDP} < 1$).

Designation of sector quota in GDP:

S_1 – agriculture, forestry and fisheries ($S_{1,1}$), mining and quarrying ($S_{1,2}$) – a sector

related to the production of raw materials for other industries;

S_2 – processing industry ($S_{2.1}$), production and supply of electricity, gas, steam and air conditioning ($S_{2.2}$); construction ($S_{2.3}$) – industries that convert raw materials into ready-to-use product (commodity);

S_3 – water supply, sewage, waste management ($S_{3.1}$); wholesale and retail trade ($S_{3.2}$); repair of motor vehicles and motorcycles ($S_{3.3}$); transport, warehousing, postal and courier activities ($S_{3.4}$) – a part of the service sector that is not related to the production and use of intellectual capital;

S_4 – information and telecommunications ($S_{4.1}$); financial and insurance activities ($S_{4.2}$); real estate transactions ($S_{4.3}$) – a part of the service sector that requires the provision of highly qualified specialists capable of producing an intellectual product of high quality;

S_5 – professional, scientific and technical activities ($S_{5.1}$); public administration and defense ($S_{5.2}$); education ($S_{5.3}$); health care and social assistance ($S_{5.4}$) – a part of the service sector S_5 , which provides activities for the production, processing and dissemination of knowledge; administrative and support services ($S_{5.5}$); compulsory social insurance ($S_{5.6}$); art, sports, entertainment and recreation; ($S_{5.7}$) provision of other types of services ($S_{5.8}$) – a part of the service sector S_5 , which performs functions of supporting the activities of economic entities and cultural and creative components of life and personality development.

The visually detailed consistent structure of the index highlights in Fig 1.

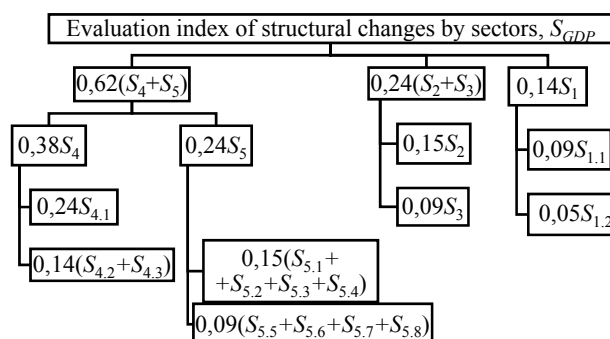

Fig. 1. Consistent structure of the integrated index of the assessment of changes in the sectoral structure of GDP.

In determining the integrated index of the assessment of changes in the sectoral structure of GDP, it should be taken into account if this index $S_{GDP} \rightarrow 1$ indicates that the structure of the sectors of the national economy does not correlate with the consistent structure as much as possible, and if $S_{GDP} \rightarrow 0$, then the structure is harmonious. The base factors used in formula (2) have the following justification: the service sector S_4 consists of indicators of economic activity, such as information and telecommunications, its share is 0.24 as the global development of information and telecommunication technologies is the basis for the emergence of new communications,

programs the processing of large amounts of data, the means of human existence in society, that is, there are qualitative changes in the structure of needs and demand, having a non-material character – recognition in society, self-realization of intellect the intellectual and creative potential of the individual. Regarding financial and insurance activities, as well as real estate transactions, the share of the sectors ($S_{4.2}+S_{4.3}$) is 0.14 because of the fact that with the development of information and communication technologies, the process of providing these services to a significant extent will adopt an electronic form. For example, Estonia has a powerful e-government system – e-tax department (submission and control of tax and customs declarations), e-notary (notary services, documentation, notary accounts), e-depository (central securities register and portfolio management of legal bodies and individuals); e-pension (self-service of individuals: applications, selection and management of funds, reporting), e-receipt (the portal for communication with banks and sellers only) [18].

The share of the part of services of the fifth sector ($S_{5.1}+S_{5.2}+S_{5.3}+S_{5.4}$) related to the knowledge economy is 0.15, because the ability of people to produce and learn new technologies, to develop high-tech products and services leads to new technological developments and occupations. The other component of the sector ($S_{5.5}+S_{5.6}+S_{5.7}+S_{5.8}$) has a share 0.09, because, first of all, the social structure of the economy of developed countries of the EU acquires a social service that allows a person to organize their leisure and protect it in society, and secondly – the receiving of the qualitative diverse services are not included in other sectors.

Relatively to industry, due to the high level of technology development in material production, there is a decrease in the resources needed to support its functioning. That's why the sector S_2 has a value 0.15.

In order to ensure its effective functioning, it is necessary for the development of services related to the development of science-intensive technologies, the latest sources of energy, robotics, etc., as the needs of companies have grown for high-quality business services connected with the diverse and complex problems of their restructuring and development.

Relatively to the utilities industry, trade, repair and maintenance of vehicles, postal services S_3 , its share is 0.09, as the development of these parts of economic activities depends directly on the previous ones – the Internet and commercial electronic platforms, the application of artificial intelligence technologies for the provision of certain types of utility and transport services.

In the primary sector, agriculture have top priority $S_{1.1}$ (share 0.09), which is associated with the problem of food security, the development of molecular and biotechnology, and the production of organic products, is a priority for agriculture, which will ensure the ecological and socially balanced development of the agro-industrial complex. Due to the development of alternative energy sources (green technologies, biofuels, wind energy, the sun, etc.), as well as with the exhaustion of natural resources, the share of extractive industry is decreasing, which has led to the allocation of a weighting coefficient of 0.05 to this sector.

Consequently, the proposed integrated index of the assessment of the structural changes in the sectoral structure of GDP, which is constructed in proportion to the «golden ratio», allows state authorities, through the calculation of deviations of

individual objective indicators, to determine strategic directions for the development of promising sectors and creation of the projected scenarios.

3 Research Findings

In accordance with the methodology for the assessment of the structural changes in the sectoral structure of GDP as above, calculations of the integrated index of deviations from the consistent structure for 2010-2017 in Ukraine and the European Union (28 countries) were made. The data of calculations of components of the index and their dynamics changes are given in table 1.

Table 1. Data for calculating structural changes in the economy of Ukraine and the EU (28 countries) over 2010-2017.

Year	Ukraine					European Union				
	S_1	S_2	S_3	S_4	S_5	S_1	S_2	S_3	S_4	S_5
2010	0.011	0.068	0.167	0.221	0.026	0.117	0.082	0.081	0.165	0.118
2011	0.031	0.059	0.181	0.232	0.037	0.114	0.083	0.080	0.165	0.117
2012	0.018	0.061	0.162	0.225	0.017	0.115	0.079	0.079	0.163	0.119
2013	0.024	0.040	0.162	0.217	0.009	0.127	0.034	0.004	0.269	0.433
2014	0.034	0.049	0.157	0.219	0.021	0.116	0.078	0.079	0.162	0.121
2015	0.058	0.045	0.157	0.224	0.036	0.119	0.082	0.080	0.163	0.120
2016	0.063	0.054	0.149	0.231	0.035	0.120	0.084	0.079	0.165	0.121
2017	0.051	0.053	0.153	0.236	0.020	0.119	0.086	0.081	0.169	0.121

Source: calculated by the author according to [19-20]

According to the methodology of the assessment of the structural changes in the economy of the European Union, a significant deviation of the integrated index in 2013 (Figure 2) should be noted, in our opinion it is due to the debt crisis in the EU and the fact that this year the UK announced its intention the exit from the European Union, and in 2016 – the Brexit process began, which in the opinion of G. Soros would lead both to the political and economic crisis – the pound fell to its lowest level for more than three decades, the financial markets entered the period of turbulence, there was an outflow of capital and labor from the real economy to the service sector [21].

For the structure of the national economy of Ukraine there is a significant deviation of the components of the integrated index S_3 and S_4 over 2013-2017. Since S_3 is the service sector, not related to the production and usage of intellectual capital (water supply, sewage, waste management, etc.), it should be noted that for Ukraine its state significantly deviates from the values of the index of the ideal structure during the investigated period. Firstly this is a outcome of the ineffective functioning and usage of outdated technologies, equipment in the system of centralized water supply and drainage, this industry needs to be re-equipped and carried out of restoration works. And secondly, such services as trade, move from classical to e-business, and therefore require very different resources (not shopping areas, but internet platforms, non-sellers,

and universal consultants (which can be replaced by special programs in the future), as well as, for example, logistics specialists – to develop the best routes for delivering goods in order to reduce overheads, specialists in site development and product rendering, etc.). That is, the prospect of the development of this service sector is the diversification of the methods of providing services using modern technologies.

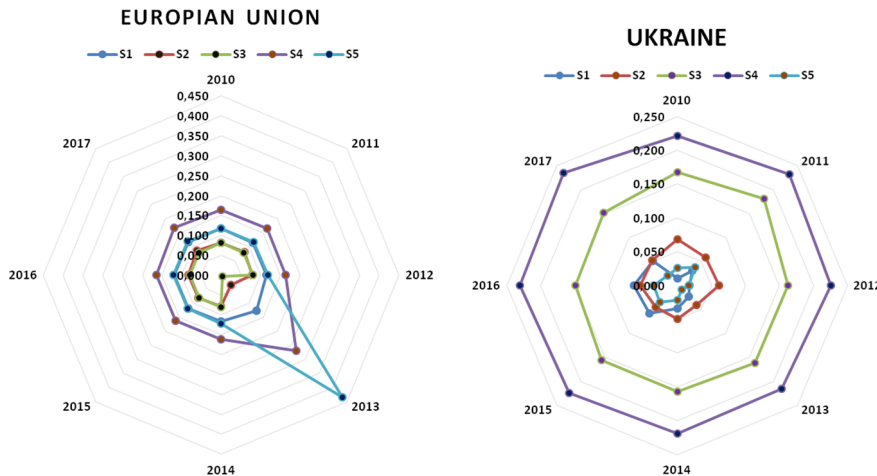

Fig. 2. Deviation of the integrated indexes for Ukraine and the European Union countries over 2010-2017. *Source:* calculated by the author according to [19-20]

The maximum deviations of the structure in Ukraine over 2010-2017 are also observed in the sector S_4 , which indicates that the domestic economy needs the provision of this sector by highly skilled specialists capable of producing an intellectual product of high quality – that is, there is a demand for specialists of certain specialties, and a training institute such personnel practically does not take into account the future needs of the market, releasing specialists, the demand for which will be practically absent in the future. That is, the higher education works with the “lag” from the needs of the post-industrial economy. It should be noted that for the European Union, sectoral deviations for S_4 are significant during the research period as compared to others, also there is a similar tendency for these industries to attract additional investment and regulatory influence from the state (EU governing bodies) for their development. The smallest deviations of the integrated index for the EU countries illustrate S_2 and S_3 (0.0179-0.081), which are the reflection of effective measures to develop high-tech and green technologies, artificial intelligence and other high-tech industries. Regarding the Ukrainian economy, the primary sector is the least deviation, due to the inertial effects of the sectoral structure, as well as the sector S_5 whose development is provided with high scientific and technical potential of Ukraine.

According to the formula (2) authors calculated the integrated index S_{GDP} for the economies of Ukraine and countries of the European Union (Fig. 3, 4).

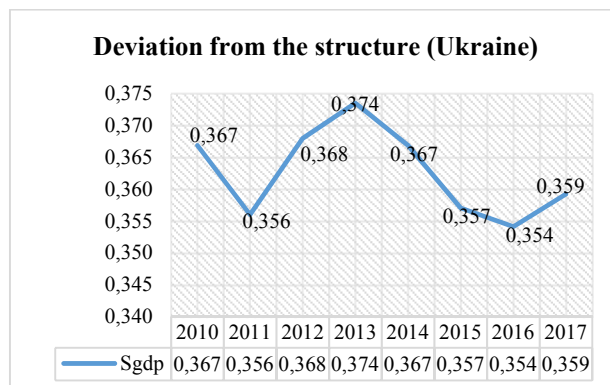

Fig. 3. Integrated index S_{GDP} of Ukraine.

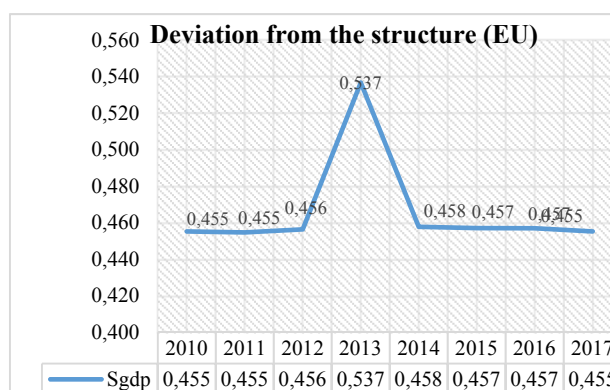

Fig. 4. Integrated index S_{GDP} of the European Union.

The calculations of the integrated index of the assessment of structural changes in the sectoral structure of GDP showed that in 2011 the Ukrainian economy was negatively affected by the cyclical economic downturn among the countries of the EU, with which Ukraine is tied to close economic ties. In 2013, both in Ukraine and in the EU countries there are significant changes in the structure of GDP, indicating the onset of crisis phenomena, which led to a sharp decline in production and redistribution of capital in the service sector. In other years, the structure of GDP in the EU countries illustrates a steady dynamic, indicating a balanced and gradual policy of the European Union regarding the sectoral development inherent in the post-industrial economy. In the Ukrainian economy, the process of transformation from the industrial stage to the post-industrial is at an initial phase, so there are significant deviations from the consistent structure in almost all selected sectors.

The reasons for the inhibition of this process are the prevalence of low-level technologies in the industry, unfavorable investment climate, political and debt crises, lack of effective policies for the development of medium and small businesses, inconsistencies in labor supply with producer needs, lack of sound public policies and

development strategies for certain industries, etc.

4 Conclusions

The calculations of the integrated index of the assessment of structural changes in the sectoral structure of GDP, which are constructed in proportion to the “golden ratio”, and its deviations over a certain period, demonstrate the crisis phenomena that took place in the economic systems of Ukraine and the EU countries at certain period. The trend of structural transformations in the Ukrainian economy indicates a gradual transition from the industrial stage of production to the post-industrial, which in turn leads to a change in the quality of capital and labor. The calculation of the degree of approximation of the existing sectoral structure of GDP to the ideal allows to develop effective scenarios for the development of the national economy firstly, and secondly, to neutralize the negative impact of crisis phenomena and reduce their consequences for the economy and society.

Also, the proposed approach to the assessment of the structural changes in the economy allows the state authorities to determine the strategic directions of development of certain sectors of the economy and to develop projected scenarios by the calculation of the deviations of the individual objective indicators of the integrated index of the assessment of structural changes in the sectoral structure of GDP.

References

1. Huntington, S.P.: *The clash of civilizations and the remaking of world order*. New York (1996)
2. Inozemtcev, V.L.: *Sovremennoe postindustrialnoe obshchestvo: priroda, protivorechia, perspektivy* (Modern Post-Industrial Society: Nature, Contradictions, Perspectives). Logos, Moskva (2000)
3. Machlup, F.: *Economic semantics*. Transaction Publishers, New Brunswick (1991)
4. Chuhno, A.A.: *Informatsiina postindustrialna ekonomika: teoriia i praktyka* (Information Post-Industrial Economics: Theory and Practice). In: Chuhno, A.A.: *Writings*, vol. 2, Kyiv (2006)
5. Sergeeva, L.N.: *Strukturnye sdvigi v postindustrialnoi ekonomike* (Structural Changes in the Post-Industrial Economy). *Models Management in a Market Economy*. 34, 60–67 (2011)
6. Kuznets, S.: *Modern Economic Growth: Rate, Structure and Spread*. Yale University Press, New Haven (1976)
7. Glaziev, S.Iu.: *Novyi tehnologicheskii uklad v sovremennoi mirovoi ekonomike* (New Technological Pattern in the Modern World Economy). *International Economics*. 5, 5–27 (2010)
8. Heiets, V.M. (ed.): *Strukturni zminy ta ekonomichni rozvytok Ukrainy* (Structural Changes and Economic Development of Ukraine). Kyiv (2011)
9. Kuzmin, O.Y., Pyroh, O.V.: *Sektorna model rozvytku natsional'noho hospodarstva Ukrainy v umovach postindustrialnoho suspilstva* (Sector Model of Development of the National Economy of Ukraine under Post-Industrial Society Conditions). *Business Inform.* 7, 8–13 (2013). http://nbuv.gov.ua/UJRN/binf_2013_7_2. Accessed 04 Mar 2019

10. Pyroh, O.V.: Ekonomichnyi rozvytok natsionalnoho hospodarstva Ukrainy: osoblyvosti ta modeli v umovach postindustrialnoho suspilstva (Economic Development of the National Economy of Ukraine: Features and Models in a Post-Industrial Society). Lviv (2013)
11. Pasinovykh, I.I.: Strukturnyi rozvytok ekonomiky ta suchasni vyklyky strukturnoi transformacii v Ukraini (Structural Development and Modern challenges of Ukrainian Economy Transformation). Socio-Economic Problems of the Modern Period of Ukraine. 1, 82–87 (2016). http://nbuv.gov.ua/UJRN/sepspu_2016_1_21. Accessed 24 Feb 2019
12. Kramarenko, A.: Strukturni zrushennia u svitovomu hospodarstvi v protsesi evoliutsii tekhnologichnykh ukladiv (Structural Changes in the Global Economy under Process of Technological Evolution). Investments: practice and experience. 1, 47–51 (2011). http://nbuv.gov.ua/UJRN/ipd_2011_4_14. Accessed 20 Feb 2019
13. Pogorzhelskaia, N.V.: Tekhnologicheskie uklady kak factor strukturnogo razvitiia sotcialno-ekonomicheskikh sistem (Technological Way as a Factor of Structural Development of Socioeconomic Systems). Economics. 13(1), 93-100 (2017). http://donnasa.ru/publish_house/journals/esgh/2017-1/11_pogorzhelskaya.pdf. Accessed 13 Feb 2019
14. Kyrychenko, O.M.: Strukturni zrushennia v haluziakh ekonomiky: svitovi tendentsii (Structural Changes in the Spheres of Economy: World Trends). Formation of market relations in Ukraine. 2(141), 27–31 (2013). http://nbuv.gov.ua/UJRN/frvu_2013_2_8. Accessed 10 Feb 2019
15. Antoniuk, V.P., Shchetinina, L.V.: Transformaciia zainiatosti za vydamy ekonomichnoi diialnosti yak indyikator strukturnykh zrushen v ekonomitsi Ukrainy (Transformation of Employment by Types of Economic Activity as an Indicator of Structural Changes in the Economy of Ukraine). The problems of economy. 4, 62–70 (2017). http://nbuv.gov.ua/UJRN/Pekon_2017_4_10. Accessed 09 Feb 2019
16. Miliutin, H.V.: Stan i strukturni zrushennia v enerhetychnomu sektori Ukrainy (The Condition of and Structural Changes in the Energy Sector of Ukraine). The problems of economy. 4, 125-137 (2017). http://nbuv.gov.ua/UJRN/Pekon_2017_4_17. Accessed 01 Feb 2019
17. Kriuchkova, I.V. (ed.): Strukturna harmonizatsiia ekonomiky Ukrainy yak chynnyk ekonomichnoho zrostantia (Structural Harmonization of the Ukrainian Economy as a Factor of Economic Growth). Express, Kyiv (2007)
18. Matviichuk, L.: E-uradiuvannia krain Baltii: dosvid dlia Ukrainy (E-government in the Baltic States: experience for Ukraine). Public administration and local government. 2(25), 159–168 (2014). http://nbuv.gov.ua/UJRN/dums_2015_2_18. Accessed 03 Feb 2019
19. Derzhavna sluzhba statystyky Ukrainy: Valovy vnutrishnii produkt vyrobnychym metodom ta valova dodana vartist za vydamy ekonomichnoii diialnosti (Gross domestic product by production method and gross value added by type of economic activity). http://ukrstat.gov.ua/operativ/operativ2008/vvp/vvp_ric/vtr_u.htm (2019). Accessed 10 Feb 2019
20. Eurostat: National accounts aggregates by industry. http://appsso.eurostat.ec.europa.eu/nui/show.do?dataset=nama_10_a64&lang=en (2019). Accessed 12 Feb 2019
21. Soros, G.: Brexit and the Future of Europe. <https://www.project-syndicate.org/commentary/brexit-eu-disintegration-inevitable-by-george-soros-2016-06?barrier=accesspaylog> (2019). Accessed 10 Mar 2019
22. Kovtun, O., Opalenko A., Ivanylova, O.: Assessment of the structural changes of the national economy of Ukraine based on the consistency. SHS Web of Conferences. 65, 04002 (2019). doi: 10.1051/shsconf/20196504002

Models of Fraud Detection and Analysis of Payment Transactions Using Machine Learning

Viktor Shpyrko^[0000-0003-4955-2685] and Bohdan Koval

Taras Shevchenko National University of Kyiv, 60, Volodymyrska Str., Kyiv, 01033, Ukraine
viksh@bigmir.net, thekovalbohdan@gmail.com

Abstract. The work's aim is to research a set of selected mathematical models and algorithms that examine the data of a single payment transaction to classify it as fraud or verified. Described models are implemented in the form of a computer code and algorithms, and therefore can be executed in real-time. The main objective is to apply different methods of machine learning to find the most accurate, in other words, the one in which the cross-validation score is maximal. Thus, the main problem to resolve is the creation of a model that could instantly detect and block a given fraudulent transaction in order to provide better security and user experience. At first, we determine the classification problem: which initial data we have, how we can interpret it to find the solution. The next part is dedicated to presenting the methods for solving the classification problem. In particular, we describe such approaches as Logistic Regression, Support Vectors Method (SVM), K-Nearest neighbours, Decision Tree Classifier and Artificial Neural Networks; provide the notion of how these methods operate the data and yield the result. At the end, we apply these methods to the provided data using Python programming language and analyze the results.

Keywords: machine learning, classification problem, fraud, payment systems, neural networks.

1 The Notion of Classification Problem and its Characteristics

1.1 The Definition of Classification Problem

The classification problem is a formalized task, which contains a set of objects (situations), divided in a certain way into classes. There is specified a finite set of objects, and we know to which classes each of them belongs. This set is called a sample. There is no info about other objects, so we do not know to what class they belong. The aim is to create an algorithm that will be able to classify an arbitrary object from the initial set.

To classify an object means to indicate the number (or name) of the class to which this object belongs.

The classification of an object is the number or class name, issued by the classification algorithm because of its application to this particular object [1].

In mathematical statistics, the classification problems are also called as the problems of discrete analysis. In machine learning, the classification problems can be solved with the help of artificial neural network methods, particularly by staging an experiment in the form of training with a teacher.

Let X be a set of object descriptions, Y is a plurality of numbers (or names) of classes. There is an unknown target dependence – mapping (1) – whose values are known only for elements of a finite learning sample (2). The aim is to construct an algorithm (3) capable of classifying any arbitrary object $x \in X$ [2].

$$y^* : X \rightarrow Y \quad (1)$$

$$X^m = \{(x_1, y_1), \dots, (x_m, y_m)\} \quad (2)$$

$$a : X \rightarrow Y \quad (3)$$

The probabilistic definition of the problem is more general. It assumes that the set of pairs “object-class” $X \times Y$ is a probabilistic space with an unknown probabilistic degree P . There is a finite study sample of observations (2) generated in accordance with the probabilistic degree P . The aim is to construct an algorithm (3), capable of classifying arbitrary object $x \in X$.

1.2 The Concept of Characteristics in the Tasks of Classification

The characteristic is the mapping (4), where D_f – the set of permissible values of the characteristic.

$$f : X \rightarrow D_f \quad (4)$$

If the characteristics f_1, \dots, f_n are given, then the vector (5) is called the characteristic description of the object $x \in X$.

$$\mathbf{x} = (f_1(x), \dots, f_n(x)) \quad (5)$$

Characteristics can be identified with the objects themselves. In this case, the set (6) is called the space of characteristics.

$$X = D_{f_1} \times \dots \times D_{f_n} \quad (6)$$

Depending on the D_f set, the characteristics are divided into the following types:

- Binary characteristics: $D_f = \{0, 1\}$;
- Nominal characteristics: D_f – finite set;
- Sequence characteristics: D_f – finite ordered set;
- Quantitative characteristics: D_f – the set of real numbers.

And into the following classes:

- Two-class classification, which technically is the easiest case, and serves as the basis for solving more complex tasks;

- Multiclass classification. The number of classes reaches thousands (for example, when recognizing hieroglyphs or fused speech), the task of classification becomes significantly more difficult;
- Non-overlapping classes;
- Ordinary classes. An object may belong to several classes at a time;
- Fuzzy classes. It is necessary to determine the degree of belonging of the object to each of the classes, usually it is a valid number from 0 to 1 [2].

In our case, we are interested in the binary characteristic of the set with a two-class specification.

1.3 Publications Dedicated to the Fraud Detection Problem

Bertrand Lebuchot and Yann-Ael Le Borgne have researched the problem in the “Deep-Learning Domain Adaptation Techniques for Credit Cards Fraud Detection” publication [3].

They worked on the design of automatic Fraud Detection Systems (FDS) able to detect fraudulent transactions with high precision and deal with the heterogeneous nature of the fraudster behavior. Indeed, the nature of the fraud behavior may strongly differ according to the payment system (e.g. e-commerce or shop terminal), the country and the population segment.

The another publication is “Improving Card Fraud Detection Through Suspicious Pattern Discovery” by Olivier Caelen and Evgueni N. Smirnov [4]. They proposed a new approach to detect credit card fraud based on suspicious payment patterns. According to their hypothesis fraudsters use stolen credit card data at specific, recurring sets of shops. They exploited this behavior to identify fraudulent transactions.

Also the problem was mentioned in “Calibrating Probability with Undersampling for Unbalanced Classification” article by Andrea Dal Pozzolo, Olivier Caelen, Gianluca Bontempi [5]. In this paper, they study analytically and experimentally how undersampling affects the posterior probability of a machine learning model. They formalize the problem of undersampling and explore the relationship between conditional probability in the presence and absence of undersampling. They use Bayes Minimum Risk theory to find the correct classification threshold and show how to adjust it after undersampling.

2 Methods of Solving the Classification Problem

2.1 Regression Methods in Solving Classification Problems

Logistic regression is suitable for solving the classification problem. This is a statistical regression method used in the case when the dependent variable is categorical, so it can acquire only two values (or, more generally, a finite set of values) [6].

Let some set Y have only two values, which are usually indicated by numbers 0 and 1. Let this value depend on some set of explanatory variables (7).

$$x = (1, x_1, x_2, \dots, x_k) \quad (7)$$

The dependence of Y on x_1, x_2, \dots, x_k can be determined by adding an additional variable y^* , where (8).

$$y^* = \theta_0 + \theta_1 x_1 + \dots + \theta_k x_k + u \quad (8)$$

Then (9):

$$Y = \begin{cases} 0, & y^* \leq 0 \\ 1, & y^* > 0 \end{cases} \quad (9)$$

The next tool is the method of support vectors – a data analysis method for classification and regression using models with controlled training with associated learning algorithms, which are called support vector machines.

For a given set of training samples, each of which is marked as belonging to one or other of the two categories, the training algorithm of the SVM builds a model that relates new samples to one or another category, making it an incredible binary linear classifier. The SVM model is the representation of samples as points in space, displayed in such a way that samples from individual categories are separated by a blank space that is most extensive. New samples then appear to the same space, and predictions about their belonging to the category are based on which side of the gaps they fall.

In addition to performing a linear classification, the SVM can effectively perform a nonlinear classification in the application of the so-called core trick, implicitly displaying its inputs to the spaces of attributes of high dimensionality.

Formally, the support vector machine builds a hyperplane, or a set of hyperplanes in a space of high or infinite dimensionality that can be used for classification, regression, and other tasks. Intuitively, good separation is achieved by a hyperplane that has the greatest distance to the nearest points of the training data of any of the classes (so-called functional separation) [7].

2.2 Discrete Methods in Solving Classification Problems

The next method for solving the problems of classification uses a slightly different approach. The method of k -nearest neighbours is a simple nonparametric classification method, where the distances (usually Euclidean) used to classify objects within the space of properties, counted among all other objects. The objects to which the distance is the smallest are selected, and they are allocated in a separate class.

The basic principle of the method of the closest neighbours is that the object is assigned to that class, which is the most common among the neighbours of this element. Neighbours are taken on the basis of a set of objects whose classes are already known, and based on the key for the given method, the value of k is calculated on which class is the most numerous among them. Each object has a finite number of attributes (dimensions). It is assumed that there is a certain set of objects with an already existing classification [7].

The next method for solving the classification tasks is the decision tree, which is used in the field of statistics and data analysis for predictive models.

The tree structure contains the following elements: “leaves” and “branches”. On the edges (“branches”) of decision trees, attributes are written, on which the target function

depends, in the “leaves” the values of the target function are written, while in other nodes there are attributes that distinguish the cases. To classify a new case, we must go down the tree to the letter and give the corresponding value. Similar decision trees are widely used in intelligent data analysis. The goal is to create a model that predicts the value of the target variable based on multiple input variables [7].

Each leaf represents the value of the target variable, changed in the course of movement from the root to the letter. Each internal node corresponds to one of the input variables. A tree can also be “studied” by dividing the output sets of variables into subsets that are based on the testing of attribute values. This process is repeated on each of the received subsets. Recursion ends when the subset in the node has the same value as the target variable, so it does not add value to the predictions. The process of going from top to bottom, TDIDT, is an example of an absorbing “greedy” algorithm, and is by far the most widespread decision tree for data, but this is not the only one possible strategy.

The decision trees used in Data Mining are of two main types:

- Analysis of the classification tree when the predicted result is a class to which the data belongs;
- Regression analysis of a tree when the predicted result can be considered as a valid number (e.g. house price, or length of stay of a patient in a hospital) [8].

In the context of the current task, we are interested in the first type of decision tree for solving classification issues.

2.3 Artificial Neural Networks in Solving Classification Problems

Artificial neural networks can also be used to solve classification problems. An artificial neural network is a network of simple elements called neurons that receive input, change their internal state (activation) according to this input, and produce an output that is dependent on input and excite. The network is formed by connecting the outputs of certain neurons with inputs of other neurons with the formation of a directed weighted graph. Scales, as well as functions that calculate excitement, can change with the process called learning, which is guided by the rule of learning [7].

Components of the artificial neural network:

1. Neurons

The neuron with the label j , which receives input $p_j(t)$ from the neuronal predecessors, consists of the following components:

- Activation $a_j(t)$, which depends on the discrete time parameter;
- The threshold θ_j (for binary neuron), which remains unchanged, if it does not change the learning function;
- Activation functions f , which calculates the new activation at the given time $t+1$ from $a_j(t)$, θ_j and the network input $p_j(t)$, giving as a result the relation (10). The function is applied to all layers except the last one (where the output function is applied). Each intermediate connection has its own activation function.

$$a_j(t+1) = f(a_j(t), p_j(t), \theta_j) \quad (10)$$

— Output functions f_{out} , which calculates the exit activation: (11)

$$o_j(t) = f_{out}(a_j(t)) \quad (11)$$

The output function is often just the same function. The input neuron has no predecessors, but serves as the login interface for the entire network. Similarly, the exit neuron has no successors, and thus serves as an interface for the output for the entire network.

2. Connections and weights

The network consists of connections, each of which transmits the output of the neuron i to the input of the neuron j . In other words, i is the precursor (parent) of j , and the j is the successor (child) of i . Each such connection is assigned w_{ij} weight.

3. Distribution Functions

The distribution function calculates the input $p_j(t)$ to the neuron j from the outputs of $o_i(t)$ of the precursor neurons and usually has the form: (12)

$$p_j(t) = \sum_i o_i(t)w_{ij} \quad (12)$$

4. The rule of training

Training rule is a rule or algorithm that changes the parameters of the neural network so that the given input to the network produces a suitable output. This learning process usually involves changing the weights and thresholds of the network variables [7].

There are three main paradigms of learning, each of which corresponds to a particular learning objective. They are guided learning, spontaneous learning, and training with reinforcement [7]. We are interested in the first paradigm, because it is used to solve classification problems.

Guided learning uses a set of examples of pairs (x, y) , $x \in X$, $y \in Y$, and has the purpose of finding a function (13) in a permitted class of functions that corresponds to these examples.

$$f: X \rightarrow Y \quad (13)$$

In other words, we want to display a reflection on which this data hints; the cost function is connected to the discrepancy between our reflection and the data, and it implicitly contains a priori knowledge of the subject domain. The tasks that fit into the guided learning paradigm are pattern recognition (also known as classification) and regression (also known as approximation of functions). A guided learning paradigm is also applicable to sequential data (for example, to the recognition of manual writing, speech and gestures). It can be seen as learning with a “teacher” in the form of a function that provides a constant feedback on the quality of the solutions obtained so far.

3 Practical Example of the Transaction Analysis and Fraud Detection Using Machine Learning

3.1 Overview and Description of the Transaction Database

To investigate this problem and find a solution, a database [9] of the payment system with transactional accounts was obtained. The database reflects transactions executed within 2 days, generally containing 284,807 transactions, of which 492 are fraud (0.172%). The dataset was gathered by Worldline and ULB (Université Libre de Bruxelles) and prepared by them using various approaches: their private software algorithms, manual testing, customers' feedback. That resulted into the merged dataset. The database consists only of numerical data. For confidentiality, the field of the database is anonymized. Because of this, it is not possible to specify a description of one or another peculiarity for which the field corresponds, and to give a more precise description of the data from an economic point of view.

All 28 parameters (V1, V2, ..., V28) were obtained using the main component method – principal component analysis method – a statistical procedure that uses an orthogonal transformation to convert a set of observations of possibly correlated variables (entities each of which takes on various numerical values) into a set of values of linearly uncorrelated variables called principal components. This transformation is defined in such a way that the first principal component has the largest possible variance (that is, accounts for as much of the variability in the data as possible), and each succeeding component in turn has the highest variance possible under the constraint that it is orthogonal to the preceding components. The resulting vectors (each being a linear combination of the variables and containing n observations) are an uncorrelated orthogonal basis set.

The only 2 fields that have not been transformed are “time” and “quantity”. The “time” value shows the number of seconds that passed between this transaction and the first transaction. The “quantity” field shows the amount of money that went through the transaction.

All other fields have no marks or legend because of security and privacy reasons. The bank decided to not share what exactly these fields are, giving only their transformed numerical values.

The data set is very unbalanced, since the target class – fraudulent transactions – is only 0.17% of all transactions (Figure 1). If we use them to construct models, we will probably get a lot of false classifications due to overtraining of the model. The resulted model will assume that the transaction is likely to be a verified one, since almost all of the data set consists of such transactions.

3.2 Initial Analysis of the Transaction Database

We need to create a balanced subset of data with the same frequency of fraudulent and verified transactions, which will help further algorithms to show more accurate results.

What will be a subset of data? In our case, this will be a dataset with a ratio of 50/50 verified and fraudulent operations. The number of fraudulent and normal operations will be the same.

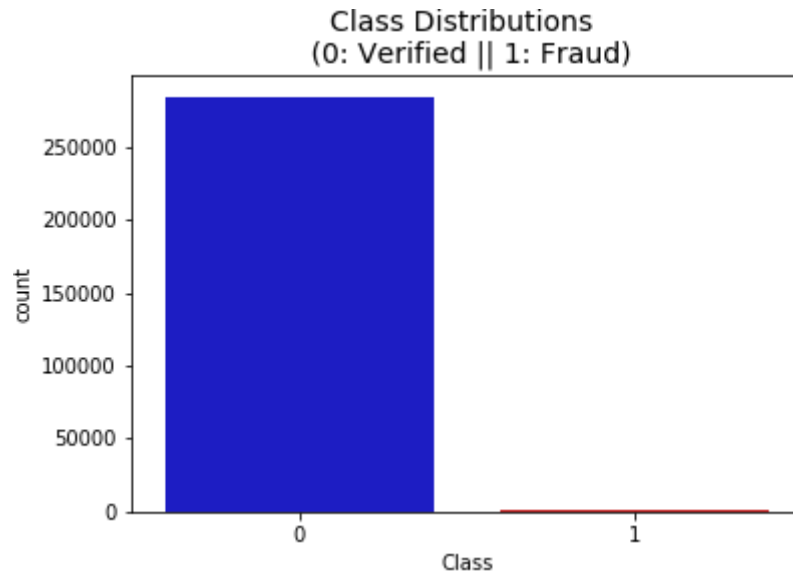

Fig. 1. Distribution of the initial transactions database by classes.

Why create a subset of data? We found that the initial set of data is very unbalanced. Its use can create the following problems:

- Overtraining. Since almost all records are verified, our model will empirically assign almost every transaction as non-fraudulent.
- Wrong correlation. Although we do not know what exactly corresponds to the “V” field, it will definitely be useful to understand how each of them affects the target function. Again, having an unbalanced set of data, the correlation matrix will be fuzzy and shifted toward non-fraud transactions [8].

Before applying random subsampling to the training set of data, we must divide the initial set of data into the training set and test set. Applying data balancing techniques (over-sampling or sub-sampling) should be done only on a training set of data in order to create a model, but the model testing should be done on the initial dataset.

In the next step, we will apply the technique of random over-sampling, which is about removing those entries from the set of data, which count is bigger. Thus, we achieve a ratio of 50/50 by excluding verified transactions (Figure 2).

Correlation matrixes are the basis for understanding the data. It is interesting for us to understand which arguments significantly affect the classification of the transaction. Particularly indicative is matrix comparison for balanced and unbalanced data sets (Figure 3).

Correlation matrix analysis:

- negative correlation: V10, V12, V14, V17. The smaller the value of these variables is, the more likely the transaction will be fraudulent.

- positive correlation: V2, V4, V11, V19. The larger the value of the variable is, the more likely the operation is fraudulent [8].

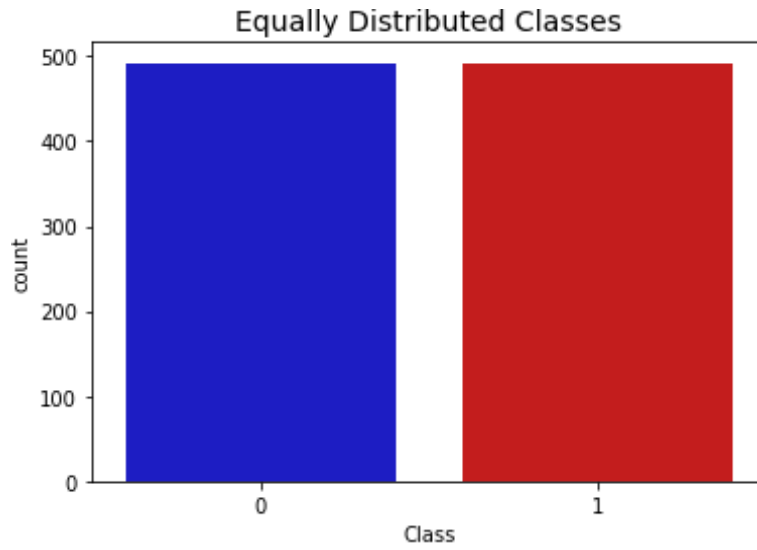

Fig. 2. Histogram of equally distributed classes after sub-sampling.

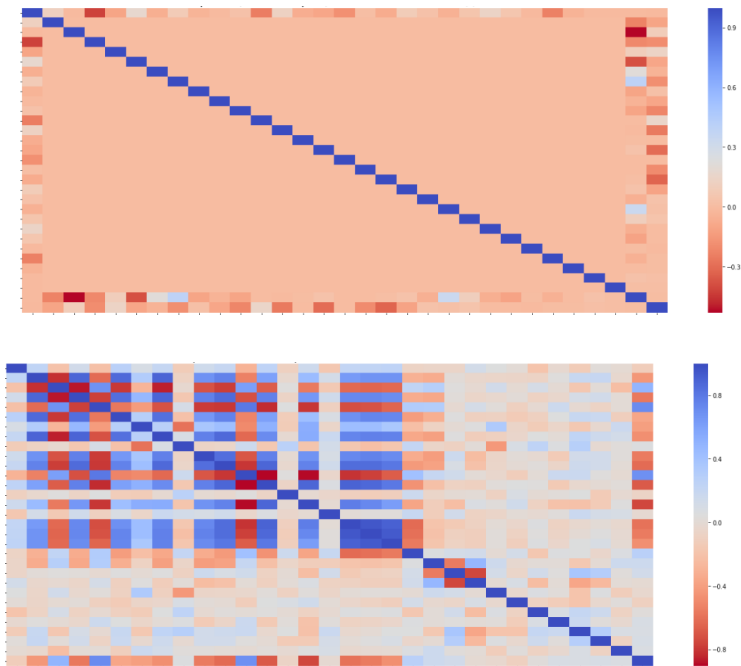

Fig. 3. Correlation matrixes of unbalanced (top) and balanced (bottom) data.

3.3 Creation and Evaluation of the Fraud Detection Classifiers

Before we begin, we need to divide our data into training and test subsets.

Of course, computing of large volumes of data and deducting the result, and, most importantly, high-speed computing, requires the use of computing machines. In practice, there are many tools and technologies for data processing, but the most popular are Python and R. What language to use is completely up to a user, the mathematical and statistical methods described above are implemented in both environments. In the given work will work in Python [10], but all the same techniques and methods are implemented in R.

We will use such libraries [11]:

- Pandas – for easier data processing;
- Matplotlib – for visualization;
- NumPy and SciPy – for scientific calculations;
- Seaborn – for visualization of statistical data;
- Sklearn – machine learning library;
- Tensorflow – machine learning library.

For each classifier, we build a model and find its accuracy [12].

After lets analyze and compare learning curves for all 4 models (Figure 4 – Figure 7):

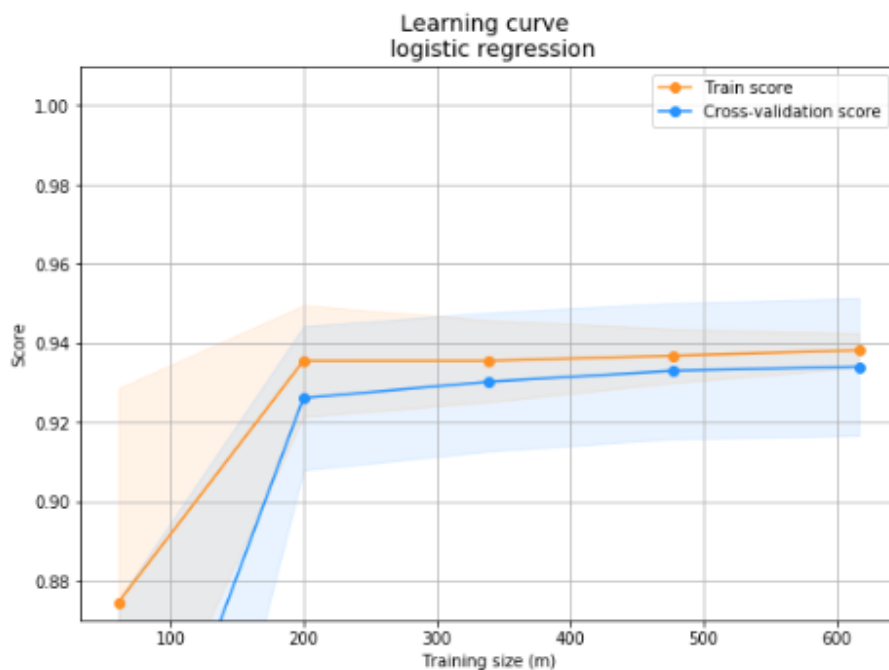

Fig. 4. Logistic regression learning curve.

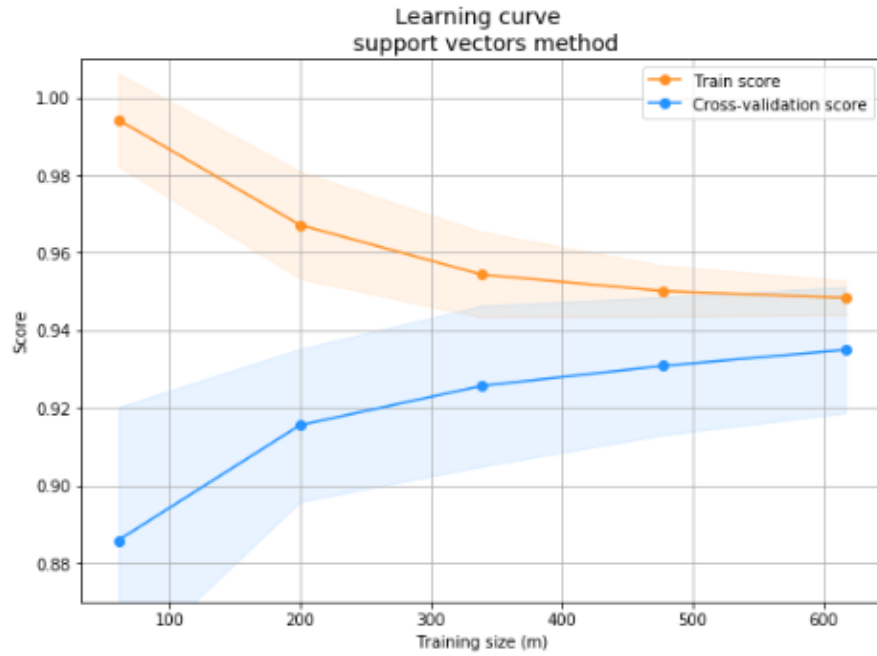

Fig. 5. Support vectors learning curve.

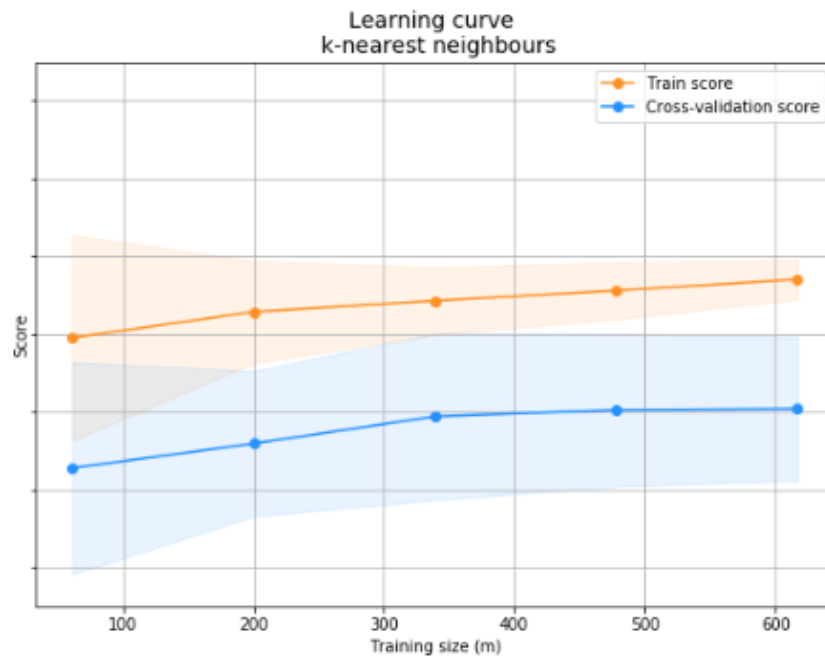

Fig. 6. K-nearest neighbours learning curve.

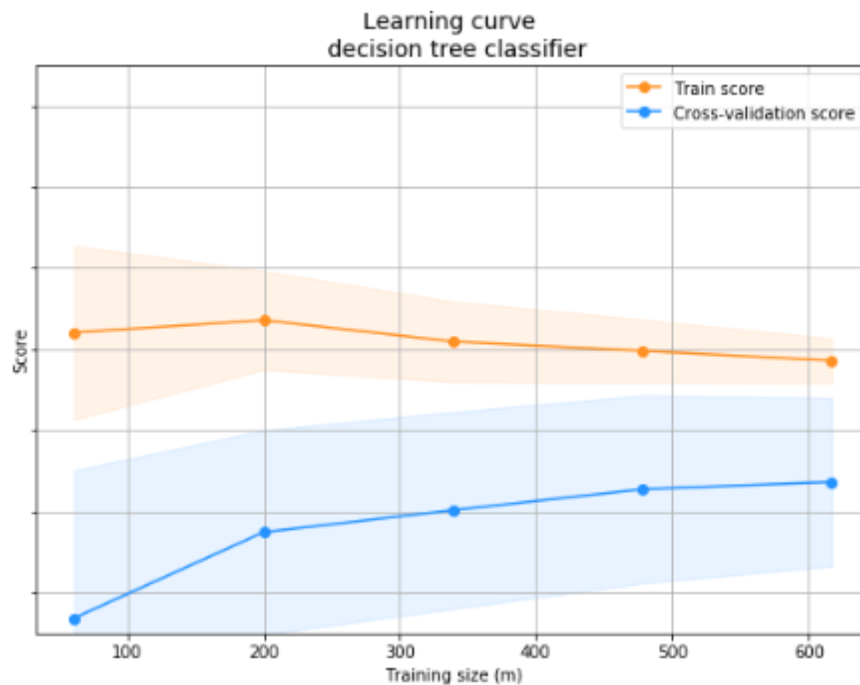

Fig. 7. Decision tree classifier learning curve.

Logistic regression showed the best accuracy with an estimate of 94%. This is a training result that was obtained from an assessment of how precisely the model determines fraud in the training sample. For a more accurate result, check the resulting models on the test sample (remember that this is still a balanced sample, so the result will still be inaccurate).

As we see from the obtained results, the logistic regression method was best demonstrated with a result of 94% on the training sample and 93.52% on the test sample (the best result was evaluated as the maximum arithmetic mean of the data of 2 indicators [13]). The method of k-nearest neighbors and the method of support vectors also showed a fairly precise result, and the support vectors method showed even better results on the test sample than the logistic regression – 93.78%.

For a more detailed demonstration of the results, we output a confusion matrix [14] for logistic regression method. In the upper left and lower right squares (yellow) the correct results are placed, in other squares (black) wrong results are places.

As we see from Figure 8, this method correctly detected $96 + 89 = 185$ transactions. The other 8 transactions fell into inappropriate groups, so they were not predicted correctly. Remember, the above results was obtained on sub-sampled test dataset.

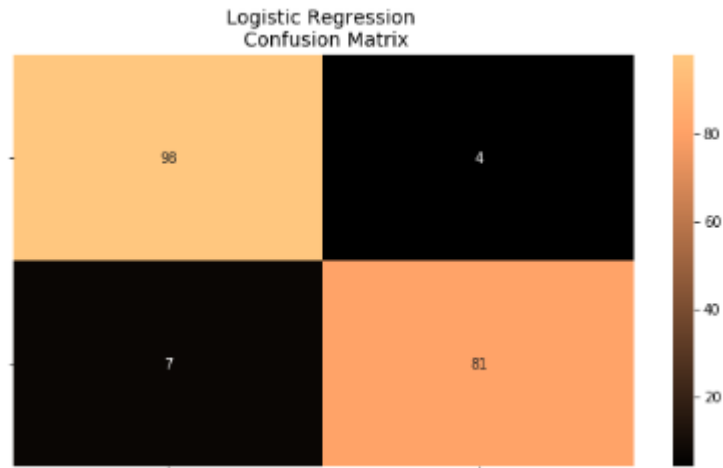

Fig. 8. Logistic regression results' confusion matrix.

3.4 Fraud Detection Using Neural Networks

To create the neural network, the same Python software package, based on the Tensorflow, was used.

The structure of the neural network: a simple model that consists of one input layer, one hidden layer of 32 nodes, and one output layer that can take one of two possible values: 0 or 1.

We will supervise two studies of the neural network: the first by means of sub-sampling, and the other by means of over-sampling. In the first case, we will narrow our data to a ratio of 50/50, so we will randomly drop a significant portion of the verified transactions. During the over-sampling, we will expand our data by adding new records of fraudulent data that will be generated basing on the existing records of the fraudulent data.

To supervise the neural network, 20 iterations were performed on the corresponding data set. After performing the neural network training, we evaluate it on the original data set and compare the results between the neural networks itself and the best classifiers.

As we see from Figure 9, the neural network on the sub-sampled data classified a significant part of the verified transactions (Y-axis) in the class of fraudulent, but only 1 fraudulent transaction passed. In general, the score of the neural network was 93.1%.

Over-sampling (data expansion) showed the best result (Figure 10) among both neural networks and all models in general, having demonstrated 99.9% of the correct classifications. However, it should be noted that 24 fraudulent transactions have passed, and therefore the percentage of blocked fraudulent transactions is lower.

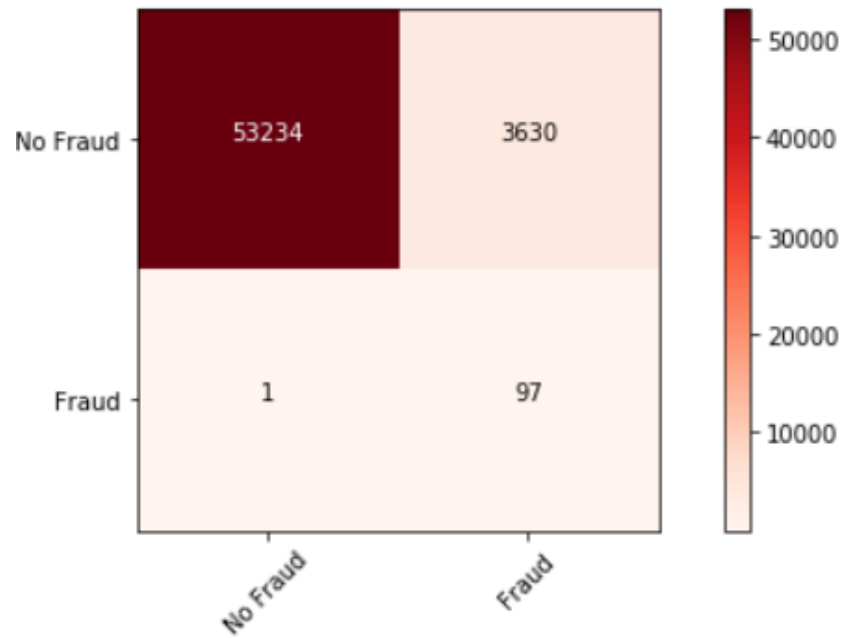

Fig. 9. Confusion matrix for the neural network, trained on sub-sampling.

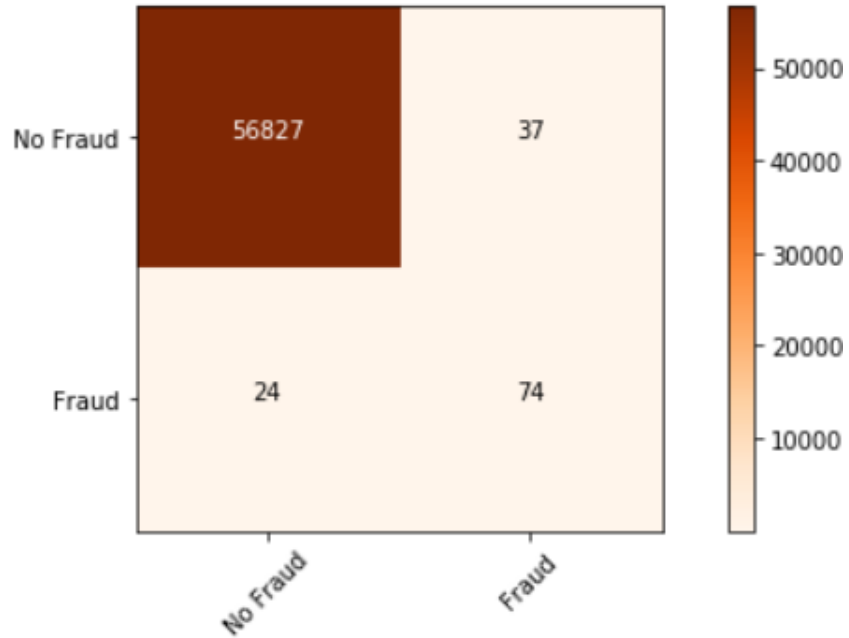

Fig. 10. Confusion matrix for the neural network, trained on over-sampling.

4 Conclusion

The logistic regression reaches up to 94% of the correct classifications, while the neural network on the sub-sampled data shows a result of 93.1%, and over-sampled data shows as much as 99.9%, but misses a significant amount of fraudulent operations.

On the one hand, the accuracy of the neural network on the over-sampling is higher, but on the other hand, it misses most of the fraudulent operations, although it better classifies the verified ones. Logistic regression showed average accuracy, but also missed a significant part of fraudulent transactions. Although the neural network on the sub-sampling showed the worst overall result of 93.1%, but it prevented the biggest amount of the fraud transactions.

In general, the use of one or another model depends on the specific situation: whether clients are ready sometimes get denial of the transaction, but to be sure that their funds will not be obtained by fraud, or they are more interested in easy of use, and security is not that important.

References

1. Ajvazyan, S.A., Buxshaber, V.M., Enyukov, Y.S., Meshalkyn, L.D.: *Prykladnaya statystyka – klasyfikatsiya i snyzhenye razmernosti (Applied Statistics – Classification and Reduction of Dimensionality)*. Finansy i statistika, Moscow (1989)
2. Hastie, T., Tibshirani, R., Friedman, J.: *The Elements of Statistical Learning: Data Mining, Inference, and Prediction*. Springer, Heidelberg (2009)
3. Lebichot, B., Le Borgne, Y.-A.: *Deep-Learning Domain Adaptation Techniques for Credit Cards Fraud Detection*. In: Oneto, L., Navarin, N., Sperduti, A., Anguita, D. (eds.) *Recent Advances in Big Data and Deep Learning*, pp. 78–88. Springer, New York (2019)
4. Caelen, O., Smirnov, E.N.: *Improving Card Fraud Detection Through Suspicious Pattern Discovery*. In: Benferhat, S., Tabia, K., Ali, M. (eds.) *Advances in Artificial Intelligence: From Theory to Practice*, pp. 181–190. Springer, New York (2017)
5. Pozzolo, A.D., Caelen, O., Bontempi, G., Johnson, R.A.: *Calibrating Probability with Undersampling for Unbalanced Classification*. Paper presented at the 2015 IEEE Symposium Series on Computational Intelligence, Cape Town, South Africa, 7-10 December 2015
6. Chernyak, O.I., Komashko, O.V., Stavyckyj, A.V., Bazhenova, O.V.: *Ekonometryka (Econometrics)*. Vydavnycho-polihrafichnyi tsentr “Kyivskiyi universytet”, Kyiv (2010)
7. Mitchell, T.: *Machine Learning*. McGraw Hill, New York (1997)
8. Shlezynher, M., Hlavach, V.: *Desyat lekcyj po statystycheskomu y strukturnomu raspoznavanyyu (Ten lectures on statistical and structural recognition)*. Naukova Dumka, Kyiv (2004)
9. Transactions database. ULB, Belgium. <http://mlg.ulb.ac.be/> (2016). Accessed 2 June 2018
10. McKinney, W.: *Python for Data Analysis*. O’Reilly Media, Sebastopol (2016)
11. Idris, I.: *Python Data Analysis Cookbook*. Packt Publishing, Birmingham (2016)
12. Michie, D., Spiegelhalter, D.J.: *Machine Learning, Neural and Statistical Classification*. University of Leeds, Leeds (1994)
13. Nilsson, N.J.: *Introduction To Machine Learning*. Stanford University, Stanford (1997)
14. Miller, J.D.: *Big Data Visualization*. Packt Publishing, Birmingham (2017)

15. Shpyrko, V., Koval, B.: Fraud detection models and payment transactions analysis using machine learning. SHS Web of Conferences. **65**, 02002 (2019). doi:10.1051/shsconf/20196502002

Assessment of Trends in the Development of the Ukrainian Economy Based on the Structural Shifts Analysis

Liudmyla Serhieieva^[0000-0003-3207-0698]

Zaporozhzhia State Medical University, 26, Mayakovsky Ave., Zaporozhzhia, 69000, Ukraine
sergieeva@optima.com.ua

Galyna Us, Iia Chudaieva

East European University of Economics and Management, 16, Nechuya-Levitskogo Str.,
Cherkasy, 18036, Ukraine
{us_galina, iiaandia}@ukr.net

Olena Makarenko

Zaporizhzhia National University, 66, Zhukovskogo Str., Zaporizhzhia, 69600, Ukraine
olenamak@gmail.com

Abstract. The article elaborates upon development trends in the economy of Ukraine taking into account structural shifts. Herewith it is proposed a stagewise procedure for the analysis of development trends of the country's economy taking into account structural changes in industry and employment by sectors of economic activity. The authors present an indicator of structural shifts and evaluate efficiency of structural changes in the Ukrainian economy. In general, the structural shifts efficiency estimation shows that they are not effective in the Ukrainian economy, as the share of the services sector is increasing, while the productivity is growing more rapidly in the industry. The use of the presented analysis procedure will allow enhance efficiency of the strategies formulation of the country's economic development.

Keywords: analysis, indicator, parameters of the economic development, structural shifts, efficiency.

1 Introduction

Country's economy is a complex economic system (CES), which comprises interrelated elements with their own characteristics and exists for a certain purpose. There are ordered and established relations between the CES elements [1]. Since the CES functions within a time interval, then in the course of time it survives changes affected by the global economy's development, i.e. the economy change from industrial to postindustrial one leads to the change in the development priorities. A commonly

recognized in the global economy is the division of economic activities into industry, agriculture, and services.

Economic activity is heterogeneous in its essence, for example, an implementation of modern technologies in manufacturing can increase the efficiency of production by reducing material costs. In construction, the use of modern technology can reduce the cost of the building and time for its development. Further, modern technologies implementation into the services sector will also lead to enhanced activity efficiency, but, for instance, by reducing the time of service provision.

Dynamics of the Ukrainian gross domestic product (GDP) structure by sectors of economic activity for the period from 2001 to 2017 is presented in Fig. 1.

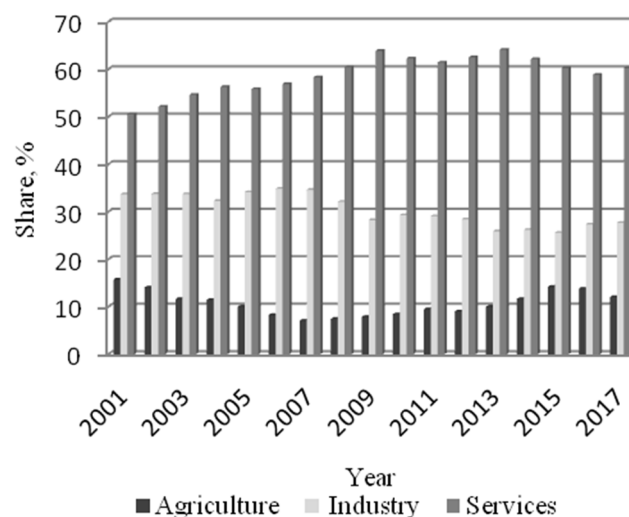

Fig. 1. Dynamics of the GDP structure by sectors of economic activity in Ukraine [2].

According to the State Statistics Service of Ukraine [2], in 2001 industry (mining, processing industry, electricity, gas, water, construction) amounted to 33.7% of GDP, services sector – 50.6%, agriculture – 15.7%. In 2017, the Ukrainian GDP structure by sectors of economic activity changed, the share of services increased by 9.7%, the share of industry decreased by 6%, and the share of agriculture decreased by 3.6% as well. Consequently, in the period from 2001 to 2017, structural changes took place in the Ukrainian economy: the share of productive industry decreased, and the non-productive increased.

The same structural changes took place in other countries. Thus, in 2012, the share of agriculture in the Germany's GDP amounted to 0.87%, industry – 26.15%, services – 72.98%. In 2018, the share of agriculture in the GDP of Germany was 0.75%, industry – 25.8%, services – 73.45% [3]. In comparison with Germany the structural shifts in the Ukrainian economy demonstrate higher rates. However, the analysis of the dynamics of the structure of world GDP shows that this structure is stable and almost unchanged, for example, in 2009, in the structure of world GDP, the share of services ranged from

63.4%, industry – 30.6%, agriculture – 6%. In 2017, the share of services was 63.6%, industry – 30%, agriculture – 6.4% [4].

According to the studies by O. Memedovik [5], the services sector has already started dominating in 1970 and accounted for 52% of world production, and in 2005 it reached 68%, the share of agriculture was 10% in 1970, in 2005 – 3.6%, the share of industry decreased from 38% to 29%. Consequently, structural changes in the global economy were subject to changes in the global economic development towards accelerated development of services.

The CES structure is the most inertial of its component. Researching the economic system structure change, that is, structural economic shifts, is an important scientific and empirical task, since the structure of a country's economy determines direction and efficiency of its development. Economy development trends evaluation based on the analysis of structural shifts should be carried out with the help of the methods of economic and mathematical modeling.

2 Analysis of the Latest Researches

Structural changes in the economy have been studied by many researchers. With the change in economic structure, priority directions of the study of structural changes also changed. A. Smith believed that the level of economic development determines the structure of the economy. D. Ricardo considered that the required condition for the economy growth was the structural change of the manufacturing system. Structural changes in time, taking into account the importance of the various sectors, were researched by N. Chenery, M. Syrquin [6]. Over time, the structure of the economy changes due to, for example, scientific and technological progress, which causes changes in production technology, which, in turn, affects the structure of employment and the structure of production in the spheres of economic activity. In addition, structural changes are also influenced by natural factors and urban processes (urbanization process). Thus, the presence of favorable natural resources allows us to develop those spheres of economic activity that use them: agriculture, industry.

A significant theoretical and practical contribution to the study of structural shifts in economic systems of various levels belongs to such scientists as V. Heyets [7], V. Galitsyn, V. Masliy, V. Ryabtsev, L. Serhieieva, V. Smal [8], and A Chukhno [9] and others. Despite the large number of scientific achievements, the issue of analyzing the trends in the development of the Ukrainian economy has not been highlighted properly, which makes this study significant.

The study of the structure of the country's economy, structural shifts and structural and functional relationships are based on the use of the structural analysis method. According to the definition of academician V. Heyets “the subject of the structural analysis is the identification and explanation of the most significant internal elements, as well as their functional purposes in the context of the object studied, with the aim to model and then forecast development as the resultant action of fundamentally structural elements” [7]. The structural analysis allows to identify trends of the CES structure changes. The task of the CES structural analysis, namely the country's economy as a

whole, is to determine the reasons for the system behavior, based on evaluation of the effectiveness of structural changes. By structural shifts we mean the change in the structure of the economic system in dynamics.

Despite a significant amount of research on the analysis of structural changes in the country's economy, estimation of trends in economic development based on the analysis of structural changes is not sufficiently considered in the scientific literature, which makes this research significant.

The purpose of the article is to study the development trends of the economy of Ukraine, taking into account the structural changes, and define indicators of the structural shifts.

3 Discussion

The analysis of structural shifts in the economy of Ukraine is proposed to be carried out in several stages (Fig. 2).

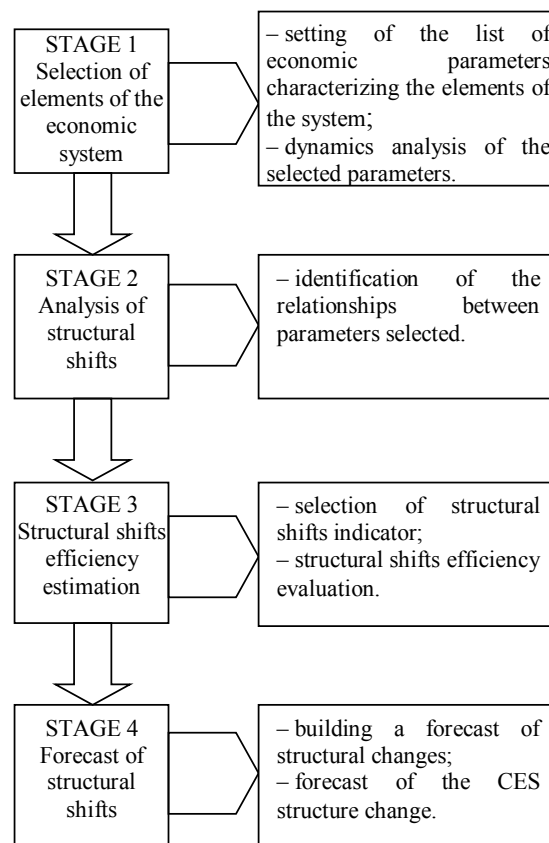

Fig. 2. Stages of the CES structural shifts analysis.

In the first stage of the economic system structural shifts analysis, it is necessary, depending on the research purpose, select the system elements. Then define the list of economic parameters for the selected elements, which characterize them and analyze the dynamic of their change.

In the second stage, the analysis of structural changes is carried out, the interrelations between the selected indicators are determined.

In the third stage of the analysis of structural changes in a complex economic system, an estimation of the effectiveness of structural changes in terms of the impact on the performance of economic activities sectors is carried out.

The fourth stage focuses on structural changes forecast. When forecasting structural indicators of the development of the CES, it is advisable to apply the forecasting method proposed by Serhieieva [10] which is based on the related socioeconomic parameters.

The procedure for the CES structural shifts analysis procedure has been applied to analyze the structural changes the Ukrainian economy.

For the analysis, statistical data for the period from 2001 to 2017 [2] were used. As mentioned above, economic sectors are selected as elements of the system: industry, agriculture, and services. GDP by type of economic activity in actual prices and the number of employees in the relevant field of activity are selected as economic indicators characterizing the elements of the system.

Dynamics of the GDP change in actual prices is presented in Fig. 3.

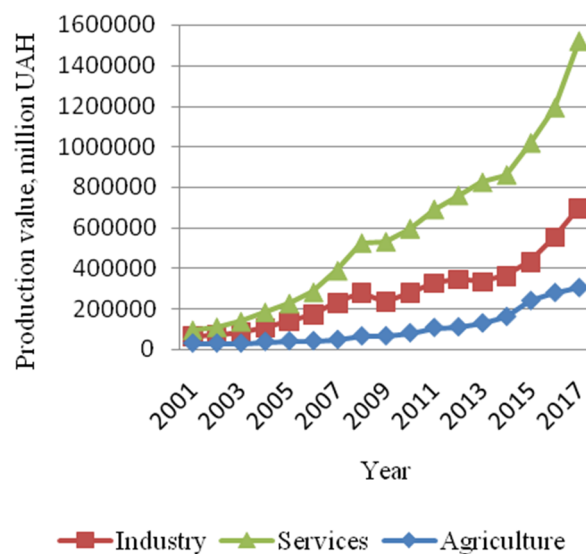

Fig. 3. Ukrainian GDP dynamics by type of economic activity in actual prices between 2001 and 2017 [2].

Thus, the dynamics of GDP change in the actual prices by sectors of economic activity is described by an exponential dependence on time and is as follows:

— agriculture:

$$Y(agr)_t = 18921e^{0.156t} \quad (1)$$

— industry:

$$Y(ind)_t = 65267e^{0.137t} \quad (2)$$

— services:

$$Y(s)_t = 96866e^{0.166t} \quad (3)$$

The analysis of the model parameters (1)-(3) confirms that rate of the GDP change is different for each sector: the services sector shows the highest growth rate, which proves its accelerated development. The agriculture sector demonstrates the lowest rate, which stands for rigidities.

The dynamics of employment rate change within sectors of economic activity is represented in Fig. 4.

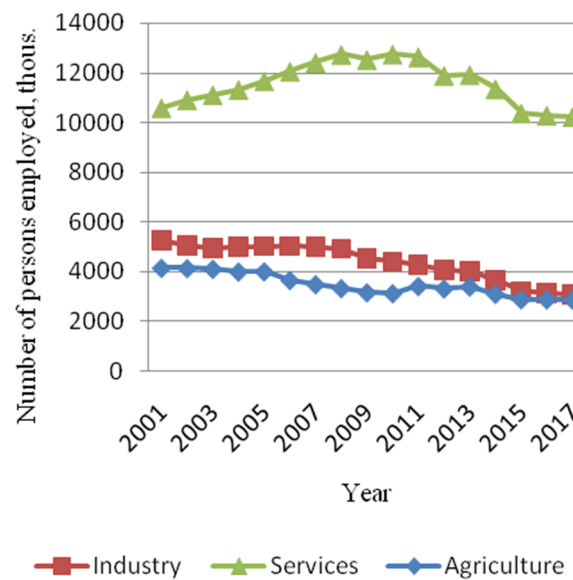

Fig. 4. Dynamics of employment by sectors in Ukraine between 2001–2007 [11].

Thus, the dynamics of changes in the number of employed persons by the sectors of economic activities is described by a parabolic dependence on time and is as follows:

— agriculture:

$$N(agr)_t = -38.04t^2 + 658.7t + 9632 \quad (4)$$

— industry:

$$N(ind)_t = -9.24t^2 + 27.17t + 5112 \quad (5)$$

— services:

$$N(s)_t = 2.712t^2 - 134.5t + 4392 \quad (6)$$

The number of persons employed by the sectors of economic activities in Ukraine tends to decline, which is due to the decrease in the number of people in Ukraine during the period under study. However, the analysis of the models (4) - (6) extremum led to the conclusion that:

- in the agriculture sector for the model (4) $t_{min} = 24.8$ which corresponds to the period between 2024 and 2025, that is, in the case of unchanged current trends before the specified period, there will be the reduction in employment, which will be followed by the growth;
- in the industry sector for the model (5) $t_{max} = 1.47$, which corresponds to the period between 2001 and 2002, the growth was observed before the specified period, which was followed by the reduction in employment;
- in the services sector for the model (6) $t_{max} = 8.66$, which corresponds to the period between 2008. and 2009, the growth was observed before the specified period, which was followed by the reduction in employment.

In the second stage of the analysis of the CES structural changes, the interrelations between the selected parameters are determined.

The linear regression models are built to analyze impact of the number of employed people on the GDP volume:

— agriculture:

$$Y(agrc)_t = 647960.3 - 156.51N(agrc)_t \quad (7)$$

$$R^2 = 0.65, F_{calc} = 27.91.$$

— industry:

$$Y(ind)_t = 122916 - 217.08N(ind)_t \quad (8)$$

$$R^2 = 0.86, F_{calc} = 89.81.$$

— services:

$$Y(s)_t = 2150274 - 135.44N(s)_t \quad (9)$$

$$R^2 = 0.09, F_{calc} = 1.42.$$

The models (7), (8) are qualitative and statistically significant with a probability of 95%. The analysis of model parameters shows that the growth of the number of people employed in agriculture and industry leads to a reduction in production volumes, such a situation in these sectors is explained by the low production efficiency. In the services sector, this trend is not confirmed, since the model (9) is statistically insignificant

In the third stage, an indicator of structural shifts at the beginning and end of the analyzed period is estimated for the analysis of the efficiency of the structural shifts in the Ukrainian economy and the efficiency of the structural shifts is determined.

Thus, the authors use a “conditional sector productivity” parameter as an indicator of the shifts, which is determined by the ratio of the GDP share in the corresponding sector to the share of the population employed in this sector, that is:

$$YP(i)_t = dY(i)_t / dN(i)_t, \quad (10)$$

where $YP(i)_t$ is a conditional productivity of i -sector of economic activity ($i=1...K$, K - number of sectors of economic activity) during period t , $dY(i)_t$ – the share of i -sector of economic activity in the country’s GDP during period t , $dN(i)_t$ – the share of the employed population in the i -sector of economic activity during period t .

If:

- $YP(i)_t < 1$, then labor force is used inefficiently in the i -sector of economic activity;
- $YP(i)_t = 1$, then labor force is used with the unity efficiency in the i -sector of economic activity;
- $YP(i)_t > 1$, then labor force is used efficiently in the i -sector of economic activity.

At each period of time t the following correlations will be performed:

$$\sum dY(i)_t = 1 \quad (11)$$

$$\sum dN(i)_t = 1 \quad (12)$$

The structural shifts shall be considered efficient if, in the structure of the economy during the analyzed period, the share of such a sector of economic activity increases, the conditional productivity of which grows at the most rapid rates.

The results of estimation of the conditional productivity parameter by sectors of economic activity in Ukraine are given in Table 1.

Table 1. Conditional productivity by sectors of economic activity in Ukraine.

Sector of economic activity	2001
Agriculture	$YP(agrc)_{2001} = 0.16/0.21 = 0.76$
Industry	$YP(ind)_{2001} = 0.34/0.26 = 1.3$
Services	$YP(s)_{2001} = 0.5/0.53 = 0.94$
	2017
Agriculture	$YP(agrc)_{2017} = 0.12/0.18 = 0.65$
Industry	$YP(ind)_{2017} = 0.27/0.193 = 1.4$
Services	$YP(s)_{2017} = 0.6/0.63 = 0.95$
	Deviation
Agriculture	-0.11
Industry	+0.10
Services	+0.01

Analyzing the data given in Table 1 the authors have come to the conclusion that the share of the Ukrainian economy in agriculture and industry is decreasing both in the

GDP and the total number of the employed people. However, if the conditional productivity in the industry sector has increased over time, it has decreased in the agriculture, which may indicate an ineffective use of the labor force, and if the current trends persist for an extended term, this type of activity may disappear.

As for the services sector, we can assume that the effective structural changes are taking place in this field of activity, but the conditional productivity has not reached unity.

In general, the structural shifts efficiency estimation shows that they are not effective in the Ukrainian economy, as the share of the services sector is increasing, while the productivity is growing more rapidly in the industry.

After the structural shifts efficiency estimation, we proceed to the fourth stage of the analysis, i.e. a structural changes forecast.

The forecast of the CES structural changes is carried out in several steps:

- building the forecast for certain structural economic parameters of the CES development, i.e. $dY(i)$, and $dN(i)$;
- building the forecast of the CES structure change.

Any socio-economic parameter has both structural and dynamic characteristics. When forecasting and putting them into the link equation, there is a violation of equality, that is, error forecasts. Since when forecasting the structural parameters of the CES development, there is a violation of the relationship equations (11)-(12), it is advisable to use a forecasting method based on related socio-economic parameters. The essence of this method is that the deviation of the forecast is distributed between the components. Due to this distribution, the forecast of the resulting parameter is corrected.

So, the forecast of the shares in the country's GDP by economic activity has been carried out.

The dynamics of the agriculture share in the country's GDP is presented in Fig. 5.

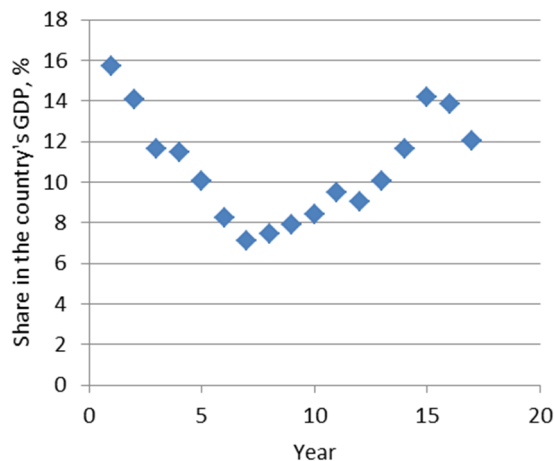

Fig. 5. The dynamics of the agriculture share in the country's GDP.

The analysis of the dynamics of the agriculture share in the country's GDP suggests that during the period of the study the trend changed twice, so, the forecast is carried out on the basis of a linear trend model, built on the last three parameters. The following model is obtained:

$$d(Y_{agrc}(t))=30.41-1.07t \quad (13)$$

The forecast for the agriculture share in the country's GDP for the next year is 11.23%.

The dynamics of the industry share in the country's GDP is presented in Fig. 6.

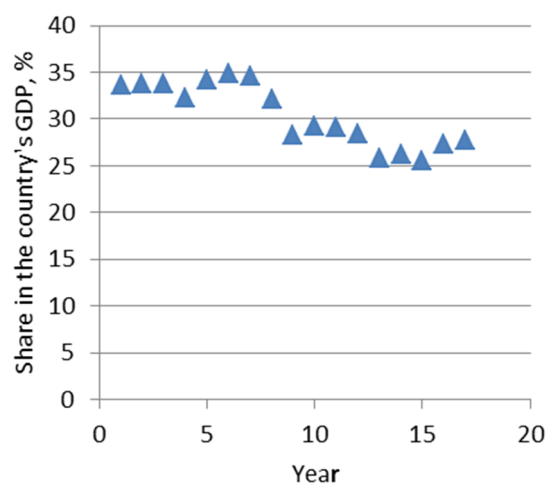

Fig. 6. The dynamics of the industry share in the country's GDP.

The analysis of the dynamics of the industry share in the country's GDP indicates a decrease in the share. The trend of this change is described by a linear dependence:

$$d(Y_{ind}(t))=35.67-0.59t \quad (14)$$

The forecast value of the share of industry in the country's GDP for the next year is 25.14%.

The dynamics of the services share in the country's GDP is presented in Fig. 7.

The services sector share in the country's GDP increases yearly. The trend of this change is described by the linear model:

$$d(Y_s(t))=53.45+0.6t \quad (15)$$

The forecast value of the services share sector in the country's GDP is 64.29%.

The sum of the forecast values of the shares of the sectors of economic activity is 100.65%, thus the forecast error is 0.65%. The discrepancy is distributed, taking into account the coefficient of determination (quality coefficient) of the linear models (13) - (15). Taking into account such considerations: the most prognostic value is

corrected for the sphere of economic activity, which has a trend model with the least determination coefficient.

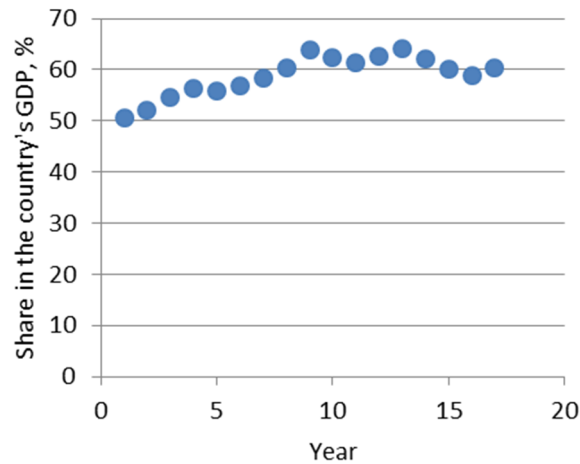

Fig. 7. The dynamics of the services share in the country's GDP.

After the distribution of the discrepancy, the following prediction values are obtained:

- the agriculture – 11.05 %;
- the industry – 24.98 %;
- the services – 63.97 %.

The essence of this method is that a forecast deviation is distributed and corrected the forecast of the resulting indicator, as well as the functions of its structural indicator.

4 Conclusions

The analysis of the trends in the development of the Ukrainian economy has led to the conclusion that there is a redistribution of the share of production and the share of people employed between the sectors of economic activity.

This work proposes a stagewise procedure for analyzing trends in the development of the country's economy, taking into account the structural changes. The indicator of structural shifts is proposed and the effectiveness of structural changes in the economy of Ukraine is determined. The structural shifts in the economy of Ukraine can not be considered effective, since the share of the services sector is growing, and the productivity in this field of activity has not even reached unity, but in the industry sector, the productivity is growing rapidly, and the share of this sector of economic activity is declining. Using the method of related socioeconomic indicators, the forecast of structural shifts in the Ukrainian economy for the next period is built.

The use of the proposed analysis procedure will improve the efficiency of the process of strategies elaboration of the country's economic development. The prospect of further research is to build a forecast of structural changes in the economy of Ukraine.

References

1. Serhieieva, L.N. (ed): Modeling of the structure of viable socio-economic systems. KPU, Zaporizhzhia (2009)
2. Production and distribution of gross domestic product by economic activity. <http://www.ukrstat.gov.ua> (2019). Accessed 12 Feb 2019
3. National accounts, domestic product. <https://www.destatis.de/EN/FactsFigures/NationalEconomyEnvironment/NationalAccounts/NationalAccounts.html> (2018). Accessed 10 Feb 2019
4. The World Factbook. <https://www.cia.gov/library/publications/the-world-factbook/> Accessed 8 Jan 2019
5. Structural Change in the World Economy: Main Features and Trends. <https://www.researchgate.net/publication/263543170> (2009). Accessed 5 Feb 2019
6. Chenery, H., Robinson, S., Syrquin, M.: Industrialization and growth, A Comparative Study. Oxford University Press, Oxford (1986)
7. Heyets, V.M, Semynozhenko, V.P., Kvasnyuk, B.Ye. (ed.): Strategic Challenges of the 21st Century for Ukrainian Society and Economy, vol. 3. Phoenix, Kyiv (2007)
8. Smal, V.V.: Tertiarisation of Ukraine economy: comparison with European Union countries. http://www.irbis-nbuv.gov.ua/cgi-bin/irbis_nbuv/cgiirbis_64.exe?I21DBN=LINK&P21DBN=UJRN&Z21ID=&S21REF=10&S21CNR=20&S21STN=1&S21FMT=ASP_meta&C21COM=S&2_S21P03=FILA=&2_S21STR=gt_2011_13_41 (2018). Accessed 21 Dec 2018
9. Chukhno, A.A.: Postindustrial economy: theory, practice and their significance for Ukraine. Logos, Kyiv (2003)
10. Knyshenko, T. (ed): Forecasting related socio-economic indicators. State and regions. 2, 52–59 (2012)
11. Number of persons employed by the type of economic activity. <http://www.ukrstat.gov.ua> (2018). Accessed 12 Feb 2019
12. Serhieieva, L., Us, G., Chudaieva, I., Makarenko, O.: Ukrainian economy development trends estimation based on the analysis of structural shifts. SHS Web of Conferences. **65**, 04003 (2019). doi:10.1051/shsconf/20196504003

Multiagent Model of Price Dispersion in the Retail Market of Petroleum Products

Leonid Galchynsky^[0000-0002-3805-1474]

National Technical University of Ukraine “Ihor Sikorsky Kyiv Polytechnic Institute”, 37,
Peremohy Ave., Kyiv, 03056, Ukraine
hleonid@gmail.com

Andriy Svydenko

Scientific-Technical Center “Psychea”, 40G, Kyrylivska Str., Kyiv, 04080, Ukraine
zulu_jp4@ukr.net

Abstract. In this study a multiagent model of behaviour of the dispersion of retail prices for petroleum products has been developed, depending on changes of external factors, in particular, sharp changes in wholesale prices. Therefore, there is a need for a model that would not only have the potential to test the existence of a price dispersion as a consequence of the specifics of competition in the market of petroleum products and consumer search strategies, but would have the ability to quantify the price variance as a consequence of the behaviour of individual market agents. The basis of the behaviour of market agents of this model is algorithms of price oligopolistic competition from traders and user price search strategies. Calibration models and verification of historical data of the Kyiv region, where they were previously established empirical data on the dispersion of prices showed a fairly good correspondence between the model and the actual data. In particular, the existence of a price pattern has been established at jump-like changes of wholesale prices. The presence of price strategy of buyers, which are based on the strategy of the base price, is shown. The coincidence of model and real data still needs to be improved.

Keywords: multiagent model, dispersion prices, petroleum products, oligopolistic competition, search strategies, dynamics of dispersion.

1 Introduction

Despite world trends in reducing the share of hydrocarbons in energy consumption, the petroleum product market remains an extremely important institution for every single economy on any continent. Relatively long history of the functioning of the market shows that the central issue of this market is price behaviour. Governments of all countries must closely monitor changes in prices, especially for their significant increase, which can lead to negative social consequences. The long-established fact, both empirical and theoretical, lies in the fact that prices in this market behave as non-

stationary time series. Some features of competition in the market of petroleum products, as well as significant sensitivity of fluctuations in the level of domestic prices from external factors, are the cause of such behaviour. The presence of the so-called price asymmetry is also a characteristic phenomenon, when jumps in prices on the wholesale market are accompanied by a rapid increase in retail prices and a slow decline in retail prices after the reduction of wholesale prices.

However, this is not the only problem in this market. Another characteristic phenomenon is the presence of price dispersion. This means that for the same product, at the same time, prices even at neighbouring gas stations are usually different. Establishing the conditions in which firms choose a range of prices and remains the main issue in the theory of prices. Starting from the pioneering work of Stigler [1], the scientific environment recognizes the role of imperfect information in shaping the equilibrium price dispersion. In numerous publications on this topic, the idea is that markets consist of consumers who receive information actively seeking lower prices, as well as consumers who remain uninformed, as they prefer to avoid the cost of searching. This behavior allows some firms to set higher prices than others in equilibrium, even when all firms sell homogeneous goods with identical production costs. Therefore, the simplest explanation for these price differences, which is that gas stations are not homogeneous in terms of costs or quality of petroleum products, is not sufficient. The main reason for the spread of prices in the market of petroleum products, as well as in the markets of other goods, is the behaviour of consumers who are trying to find a bargain price. However, establishing evidence that price dispersion is the result of an inadequate search for consumer spending is not a trivial task. Empirical studies mostly relied on comparative statistics to determine the role of search in this market. In a number of studies, regressive dependencies of the price dispersion from the intermediate part of the search expense are set, while others create a quantity dependence and price dispersion from the number of firms on the market, which allows for a formal test for the existence of the price dispersion. In particular, the theoretical dependence between the search intensity and the price dispersion, which is nonmonotonic, as well as the reverse, confirms the role of the search, is established. In particular, the theoretical dependence between the intensity of the search and the price variance is established, which is nonmonotonic and also inverse, which confirms the role of the search. However, there is a need to construct a model that could describe the mechanism of generating a dispersion of prices in the petroleum product market and allow an assessment of this change in dispersion over the short term.

2 Related Works

G. Stigler has a fundamental paper [1] in which the phenomenon of price dispersion for a homogeneous product is established due to incomplete consumer awareness. In addition, it introduces the concepts of search and price dispersion – “A buyer (or seller) who wants to identify the most favourable price must be able to identify the various sellers (or buyers) – a phenomenon I will term search”. However, this paper did not establish a direct link between price dispersions and user searches. Moreover, Diamond

[2] discovered the famous paradox, establishing a “law of one price”, on which the price can hold, despite the imperfect information. The Diamond’s paper really shows that even with the cost of searching for standard terms of the oligopoly of Bertrand, there is a unique equilibrium with a monopoly price. A little later, in the paper [3], it was shown that the market equilibrium is achieved not at one price, but at a certain price distribution. The fundamentals of customer search theory and its role in price dispersion were laid down by Varian [4]. The most common assumptions about the optimal rules for finding this theory are:

- Firms sell absolutely homogeneous goods;
- Consumers carry the search costs to find prices beyond the first price;
- The price distribution is fully assumed by consumers;
- Consumers can do different ways of searching: for example, a consistent search by which consumers disclose one price by another at random;
- The optimal search rule is then reduced to a backup price (constant if the search cost is linear).
- Search ceases as soon as the price is below the reserve price.

Varian has shown that there is no equilibrium in pure strategies, but equilibrium is achieved in mixed strategies. Diamond’s paradox and Bertrand’s competition are extreme cases when all consumers are informed or not informed. This paper looks at the interesting conclusion about increasing the number of companies operating in the market. When the number of competitors increases, the likelihood that any particular seller will successfully sell the product to some informed clients is reduced. As a consequence, in the equilibrium distribution of prices, higher prices increase their share. But this effect turns out to be positive for informed customers, because the expected lower price is decreasing. The reason is that more firms compete and well-informed buyers pay the lowest price. For unskilled clients, the expected price is clearly increasing. The gasoline market is a good example of a homogeneous, albeit not perfect, market where price dispersions are observed. Many consumers are only aware of some prices, and this gives some monopoly power to gas stations. In many cases, consumers find themselves in a situation where fuel runs out and have no choice other than filling their petrol tanks at the first-best filling station they are facing, which gives additional market power for gas stations. Prices change quite often, and to determine which gasoline station has the cheapest fuel in this market is a non-trivial task. The price variation in the fuel markets was widely documented in the scientific literature. In particular, publications on this topic [5-10] examined the dependence of the price dispersion on the density of vendors on the number of gas stations in the radius of 1.5 – 2.5 miles around each station.

The price variation is measured by unexplained price fluctuations, namely, the square of the residues of the logarithmic regression of market characteristics, including the density of sellers. It was established that the increase in the number of neighbouring gas stations is associated with a decrease in the price dispersion. Lewis [8] agrees on two previous approaches, using station-level data to control differentiation, and examines the link between price variability and local market characteristics. The data includes prices for 327 gas stations in the San Diego area each Monday 2000 and 2001

(91 weeks). The paper finds a negative connection between the density of sellers and the price dispersion, as in [6], and confirms and complements this result by introducing the difference between the groups of consumers who use elite fuel and groups that use simpler fuel grades. According to [9], data on petrol prices from the Netherlands showed that with increasing competition, the price dispersion is increasing: low prices are decreasing and high prices rise on average. As a result, competition has an asymmetric impact on prices, and all consumers, regardless of the amount of prices they are watching, benefit from an increase in the number of gas stations. However, the gain from this is greater for informed consumers. The model proposed by [10], and develops the Varian's sales model, yielded the following results.

Identification of the role of imperfect information cannot be made by simply checking the usual comparative static of the dispersion of prices for costs or benefits of the search, or the number of enterprises on the market. Price dispersion becomes a nonmonotonic function of these variables if we allow consumers to adjust their strategies for finding equilibrium. Using a new test of rank spreads and price spreads between pairs of stations, it has been found that the time dispersion of the prices at the market level is consistently higher than for stations at one crossroads. This is consistent with the theory of consumer search, since the dispersion in the latter group is carried out only through the differentiation of petroleum products. At the same time, the assumption that the development of modern communication technologies will automatically eliminate the problem of the variance of prices themselves did not justify. So, on the data of Italian motorways [11], found that increasing transparency of prices had little effect on the level of price dispersion. Analysis of customer transaction data shows that less than 10% of consumers effectively use price data.

The above results of outstanding researchers have proved not only the existence of a dispersion of prices in the market of petroleum products as a consequence of the search behavior of buyers, but also allowed to find quantitative dependence of price characteristics on the infrastructure parameters of the market and the behavior of market actors. However, many questions remain unclear. One of the difficult problems is the estimation of the change in the variance of retail prices in the case of spin-off changes in wholesale prices. As already noted, in such cases there is a phenomenon of price asymmetry caused by the behavior of participants in the oligopolistic market of petroleum products. This phenomenon was not studied by the classical theory, but in recent decades, by the efforts of many researchers, this gap has largely been overcome, but only with the assumption of a hypothesis of a single price. The question of how the variation in retail prices in wholesale jumps has attracted the attention of researchers recently, in particular Noel [12], based on retail gas prices (known as Edgeworth price cycles), has established a two-way link between price dispersion and consumer search. The search activity not only affects the variance, as it was well documented, but the price variance also affects the search. This is an extremely interesting result, which, however, did not eliminate the need to develop a model for assessing the dynamics of the dispersion of retail prices at the usual wholesale price jumps, and not for the case of exogenous shocks, as was investigated by Noel. For this non-trivial problem, it is necessary to have an appropriate methodology for the solution.

3 Data analysis

In this paper we study of the level of dispersion and its dynamics at the data on gasoline prices in the retail market of petroleum products of Ukraine for separate filling stations were provided by the Scientific-Technical Centre “Psychea”. The choice of gasoline, as a fuel, is explained by the higher homogeneity of consumers, compared with consumers of diesel fuel. However, despite the homogeneity of the market of petroleum products, in particular the gasoline market, the product market boundaries were clearly limited to cover the most homogeneous product:

- Only non-branded gasoline, which falls under the state standard of quality, is involved in the consideration.
- Gasoline of the brand A-95 is considered, because this type of fuel has the most homogeneity of consumers.

A comparative analysis of regional petroleum products markets in Ukraine showed existent of a daily dispersion of prices for gas stations belonging to different owners, as well as a significant difference in the level of price dispersion between individual regions of the country (Fig. 1, 2). Although there is a certain correlation between the level of retail prices and the level of dispersion, the market concentration may also affect the level of dispersion. Therefore, the study of the phenomenon of price dispersion is advisable to do for individual regions, and not for the whole country as a whole, because it will distort the results. Therefore, a sample of historical data of retail prices for A-95 gasoline of the Kyiv region for the period 2012-2017 was selected for the study.



Fig. 1. Dynamics of dispersion to gasoline A-95 in accordance with the defined product market boundaries.

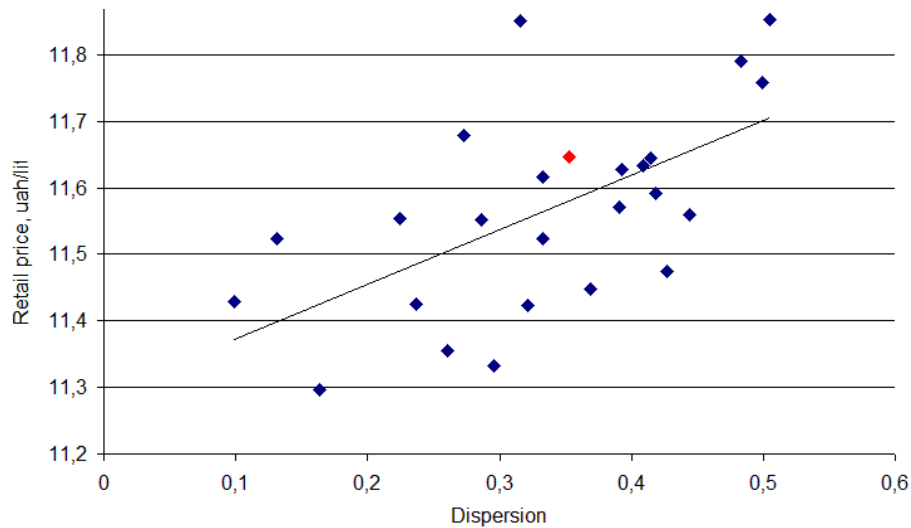

Fig. 2. Territorial dispersion of petroleum product prices and its dependence on retail prices by region of Ukraine.

The analysis behaviour gasoline prices for years 2012-2017 showed that most developments in the petroleum product market characterized by unique dispersion, but for intermittent changes in retail prices, to some extent, can assert the presence of the characteristic pattern of behaviour dispersion. In Fig. 3 shows a typical pattern of dispersion behaviour at a jump in retail prices caused by fluctuations in world oil prices. A characteristic feature of the dispersion is a significantly higher level of dispersion in the course of price growth and its return to the initial level during a decline.

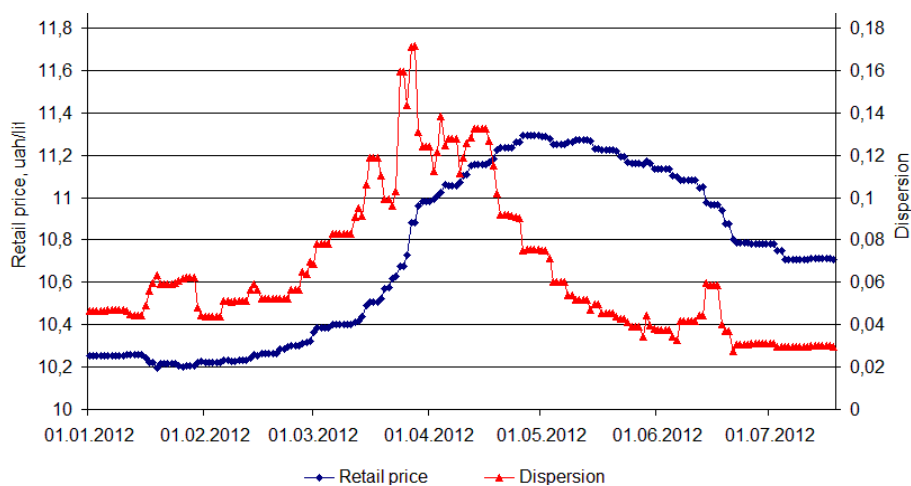

Fig. 3. Typical behavior pattern of dispersion during a wholesale price surge caused by fluctuations in world oil prices.

4 Model

There are many models of behavior of retail prices in the market of petroleum products. The overwhelming majority, including those that quantify the price dispersion phenomenon in the fuel market, are based on econometric approaches. However, for the study of the influence of the behavior of individual market agents on the behavior of market prices, the multi-agent approach seems more relevant. The bottom line is that multi-agent model of petroleum product markets can more flexibly take into account the different structure and rules for the functioning of national markets and the behavior of market agents.

The model of [13] focuses on the interaction between gas stations and the diffusion of prices from one gas station to another in the territorial dimension. Many aspects of using the multi-agent approach to competition in oligopolistic markets were studied by [14-15]. The agent who makes the decision to change the price is a gas station and the influence of the gas station owner is absent. However, this approach is not universal. In some markets for petroleum products, in particular in the Ukrainian petroleum product market, prices for each of the gas stations are set by the owners of the networks. Prices can be the same at all gas stations or different, but at the same time during the change in prices observed their equal increase in absolute terms. This approach was implemented for the model of the phenomenon of asymmetry of retail prices and their prediction in the retail market of petroleum products in Ukraine [16]. For these models, the main indicator, on the basis of which the conformity of the model with real data was checked, was determined by the average retail price. Such a model enables to reproduce the behaviour of retail networks, based on a comparison of the average price in the model and the average market price. However, the analysis of the behaviour of dynamics of price dispersion in this model was not foreseen. To show this phenomenon, the model has been refined. So let's determine the main assumptions and simplifications that are put into the model:

- At the gas station only one type of fuel is used (gasoline A-95).
- Consumers have only cars.
- The market is limited to a certain area.
- The list of retail networks is deterministic and unchanged.
- Retail networks change prices at the same time at all gas stations and at the same absolute value.
- The location of the gas station corresponds to their actual location in the specified area.
- Consumers are evenly distributed throughout the territory.

It should also be noted that an improved multi-agent model takes into account the basic means of state regulation of the pricing of retail networks. In particular, unlike petroleum products markets in some countries, where the change in retail prices is not forbidden for one day, the model takes into account the rule that operates in the Ukrainian petroleum product market, where retail networks can only change prices once a day. In the multi-agent petroleum market model there are the following agents: retail chain, gas station, consumer and trader. According to the model, the daily

activities of petroleum products trading consist of the following actions: consumers purchase fuel, retail networks collect statistics from gas stations, gas stations if necessary, order a new consignment of fuel from the trader, interaction between the gas station and the trader, retail networks analysing all available information, set prices for the next day. The software model is represented by the following class diagram (Fig. 4).

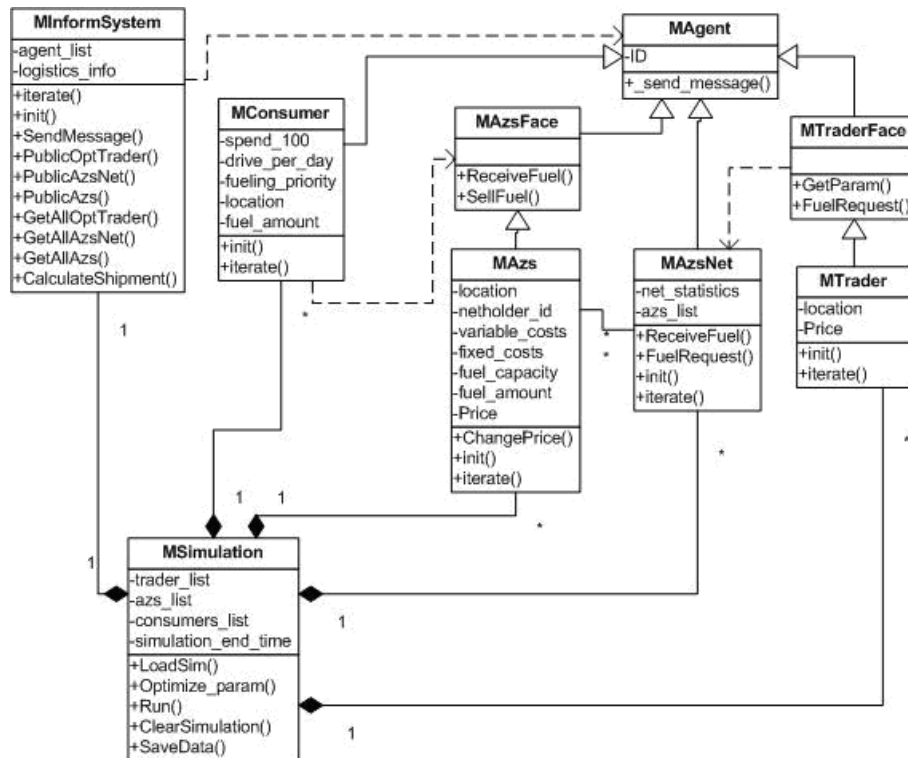

Fig. 4. Diagram of classes in agent model.

The base class of each agent is MAgent, which is followed by agents of the gas station (MAzs class), retail network (MAzsNet class) and trader (class MTrader). For abstraction of a separate modeling, there is the MSimulation class, which manages the whole model and provides a set of tools for working with the model. The MInformSystem class is an interface for agent communication and information support. It should be noted that in the absence of a dedicated state agent, his functions in this model are assigned to this class, namely: to provide information on the list of taxes paid by retail networks and their current rates. The dynamics of the interaction between the flows of agents is shown in Fig. 5.

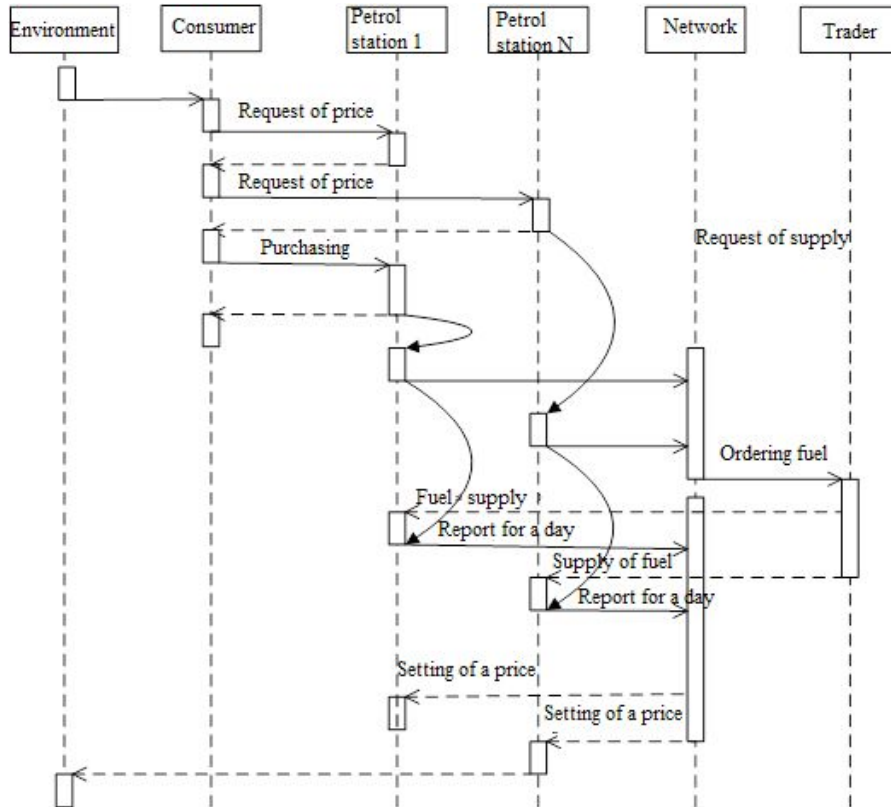

Fig. 5. Interactions between the flows of agents.

4.1 Algorithm of Retail Networks Behaviour

In the proposed multi-agent model, the algorithm for retail network behaviour is based on states. The model outlines the following agent states retail network: market follow-up (S1), strategy changes (S2), trade stop (S3), return to market (S4). State S1 implements the behaviour of the agent in the presence of profits during periods of decline in prices and for their minor fluctuations during periods of high margins. State S2 realizes the agent's response to a sharp change in the market situation: a leap of prices, a sharp decline in demand, and so on. The states S3 and S4 implement market exit strategies if it is impossible to get the profit and return to the market in the event of such an opportunity. Fig. 6 shows a diagram of states of the mechanism of decision-making by the agent "Network".

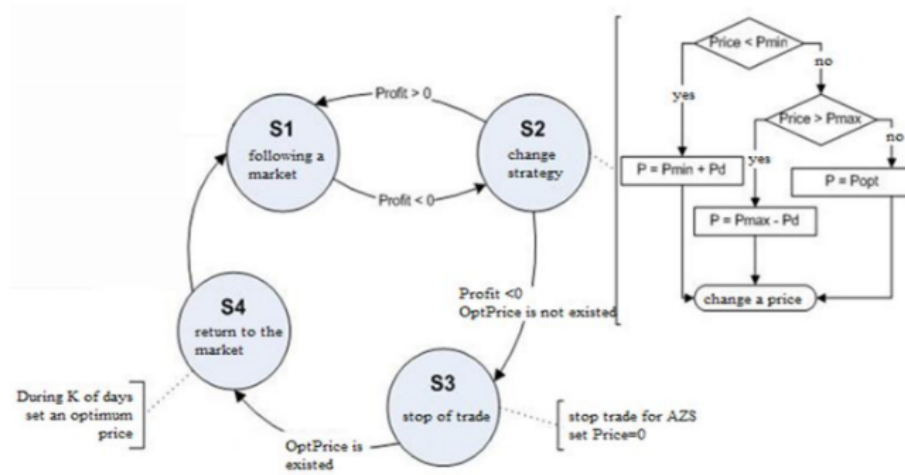

Fig. 6. Diagram of the states of the mechanism of decision-making by the agent "Network".

Agent's behavioral algorithm Network in state S1 has the following appearance:

```

IF price_c == 0 THEN
  IF last_buy_price_c > 0 THEN
    delta = (optimal_price - price) *
    PrM * last_buy_price_c *
    0.35 + (current_trader_price - last_buy_price) * Trk * 0.45 -
    0.2 * competitors_price_c * Ck;
  ELSE
    IF last_by_price_c < 0 THEN
      delta = (current_trader_price -
      last_buy_price) * Trk * 0.2 +
      0.2 * last_buy_price_c *
      competitors_price_c * Ck +
      0.2 * (competitors_price -
      price) * Pd;
    ELSE
      IF competitors_price_c < Pd2 OR
      current_trader_price_c < 0 THEN
        delta = (current_trader_price -
        last_buy_price) * Trk *
        0.5 + 0.5 *
        competitors_price_c * Ck;
      ELSE
        delta = (optimal_price -
        price) * PrM *
        last_buy_price_c;
    END
  END

```

```

    END
  END
ELSE
  IF price_c > 0 AND
current_trader_price_c < 0 AND
competitors_prrice_c < 0 AND
competitors_prrice - price < -0.5 THEN
    delta = (competitors_prrice - price)*Pd;
  ELSE
    IF price_c > 0 AND price_c < Pd AND
current_trader_price_c < 0.1 THEN
      delta = (optimal_price - price) *
PrM * last_buy_prrice_c * 0.75 +
0.25 * competitors_prrice_c * Ck;
    ELSE
      delta = 0;
    END
  END
END
price = price + delta;

```

To analyse the current situation, each agent has a statistical module that, with the help of the Ordinary Least Squares method, linearly defines the trajectory of the main indicators. Variables with suffixes “_c” denote the coefficient of the linear equation with the corresponding variable. Analysis of real data showed that retail networks mostly do not adjust the prices daily for a small value, and make a change in prices at least a certain value (usually it is 0.1 – 0.3 UAH / litre). Therefore, for the formation of the correct dispersion dynamics, the rules for the formation of threshold price changes by each network are additionally prescribed. In addition, in the price change algorithm, 3 main drivers are allocated, which form the necessary level of prices in the usual situation:

- The behaviour of wholesale (current_trader_price) prices with respect to the prices of last fuel purchases (last_by_price).
- Price behaviour of competing networks (competitors_prrice).
- Optimal price that maximizes profit (optimal_price).

We determine the optimum price as maximizing the profit of the retail network, taking into account current demand:

$$profit = D(P, P_{avg}) \cdot (P - Tax - Costs) \rightarrow \max \quad (1)$$

$$P_c < P < 1.4 \cdot P_{avg} \quad (2)$$

where $D(P, P_{avg}) = a_0 - a_1 \frac{P - P_{avg}}{P_{avg}}$ – function of estimating the volume of sales of fuel

at the gas station; P_{avg} – average fuel price within a radius of K km from the location of the gas station; P – the fuel price of the agent, the variable for which the optimization takes place; Tax – Tax Component; $Costs$ – Costs; P_c – the price of fuel purchases. The demand function coefficients (α_0 and α_1) are automatically evaluated for each agent individually and specified at each step of the model during simulation. It should be noted that the establishment of both the upper and lower bounds of this indicator is dictated by both insufficiently studied demand function and consumer behaviour. The formation of the initial level of dispersion is achieved by setting variables and constant costs for each network based on real estimates of these indicators with some correction on the assumption of model and the stability of the initial state of the model.

4.2 Algorithms of Consumer Behaviour

As the results of previous studies have shown, consumer strategy with the search for a base price can generate asymmetric behaviour of retail prices. Therefore, based on the basic algorithm of consumer behaviour, the search for the base price is chosen: the consumer searches until he finds a price not higher than the price of the previous purchase. At the same time, as you know, consumers are not homogeneous, and among them there are groups with other patterns of behaviour: consumer orientation at the price and random selection of gas stations.

The algorithm of consumer behaviour with the search for the base price is presented in Fig. 7. The consumer makes several attempts to find a price lower than the price of the last purchase of fuel. In the basic version of the model, the number of attempts to search is 5. The behaviour of consumers without a search is equivalent to a uniform distribution of demand for all filling stations. The scheme of the algorithm is shown in Fig. 8.

The behavior of price-oriented consumers is carried out by the construction by each consumer of distribution at the gas station in accordance with the price level at the gas station. The basis of such a distribution is an exponential distribution with modifications based on the following empirical assumptions: the consumer is guided by the relative price level when selecting a gas station, the lower the price, the greater the probability of choosing this gas station. Given the complexity of estimating the additional distribution parameters it is assumed that the mathematical expectation is equal to 1, and the density function has the following form as follows:

$$prob = \frac{1}{k} e^{-(price - \min(price))} \quad (3)$$

where $price$ – price at the gas station, $\min(price)$ – the minimum price among all the gas stations in the field of consumer's vision, k – the coefficient of normalization of distribution density:

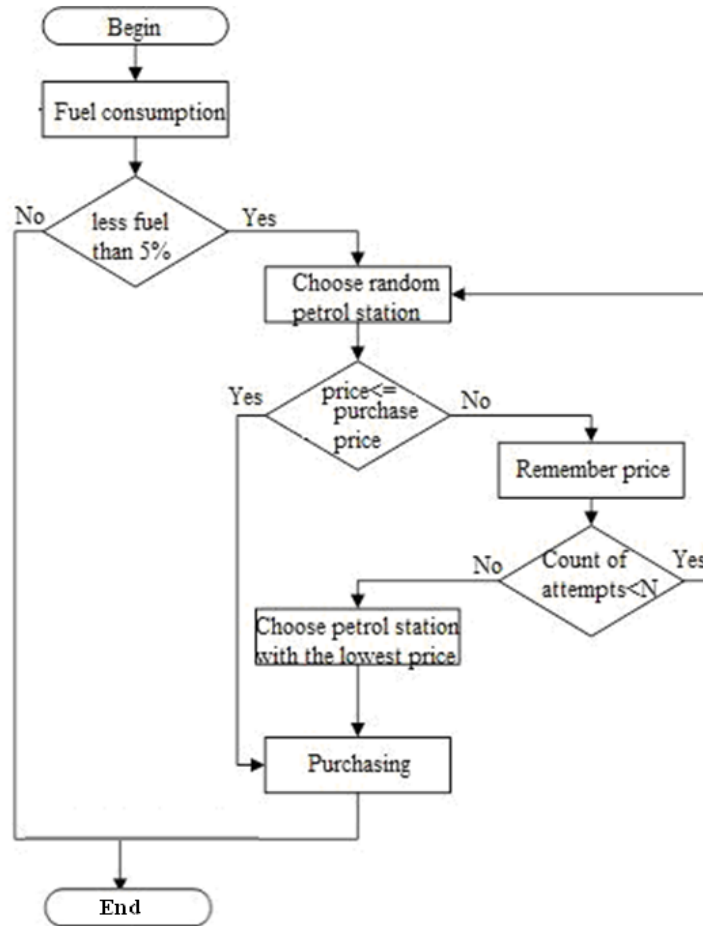

Fig. 7. Consumer behavior with the search for the base price.

$$k = \sum_{i=1}^M e^{-(price_i - \min(price))} \quad (4)$$

where M – amount of fuel station that in field of consumer’s vision. This list of observed gas stations prepared for each consumer using empirical assumption that maximum distance from consumer location to station must not exceed 7 km. This value was determined on the basis of a survey of drivers in the region of Kyiv and has a preliminary assessment character, which requires a separate study. However, in order of magnitude it coincides with the values of the authors in the literature cited above.

Due to the lack of reliable data on consumer preferences in the choice of gas stations, the basic algorithm of consumer behaviour will be considered the algorithm for finding the base price. However, for comparison, all types of consumer behaviour algorithms were used.

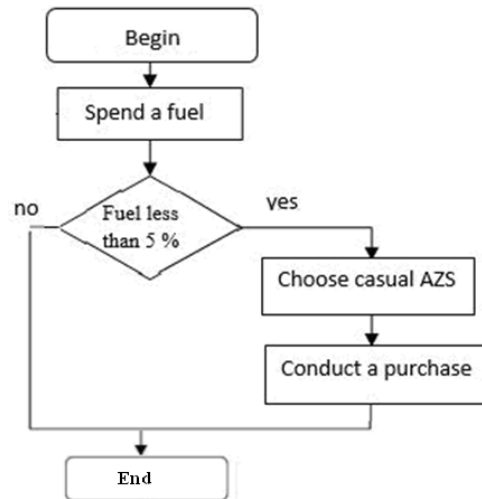

Fig. 8. Behavior of consumers without searching.

5 Experimental Results

Nelder-Mead method was used to calibrate the model. The criterion of optimality was the sum of absolute deviations of average retail prices in the model from their real values. In total, 130 steps were taken to select the optimal model parameters. These parameters are the following parameters (the notation corresponds to the variables in algorithm above):

- PrM (with value 7.1195) – optimal price correction coefficient, which determines the effect of the deviation of the calculated optimal price from the current price at the gas station;
- Pd (with value 0.05) – a coefficient that determines the magnitude of the impact of competitors prices absolute value on the price of gas stations;
- Ck (with value -2.8899) – coefficient, which determines the influence of the price trend of competitors to the price of gas stations;
- Trk (with value 1.0292) – coefficient, which determines the effect of wholesale prices change on the price at the gas station;
- Pd2 (with value -16.861) – the threshold of competitors average price delta, which is used to switch the pricing approach in the algorithm.

As a result of the selection of parameters, it was possible to achieve qualitative detection of the dynamics of retail prices (Fig. 9), while the dynamics of dispersion repeats the actual trends (Fig. 10). That is, the multi-agent model identifies a pattern of price dynamics and dynamics of price dispersion. It should be noted that in general, some discrepancy between the finite level of the real and the model dispersion can be dictated by the local peculiarity of the jump. A slightly lower dispersion level of 75-90 model days is caused by the early reaction of retail networks of the lower price segment. Such

an early reaction to the rise in prices in these networks is due to the existence of a single algorithm of behaviour as retail networks operating on both purchased fuel and self-produced fuel. Therefore, in some cases, the decision to change prices in such networks may occur somewhat later than other networks in connection with the monthly schedule of processing capacity.

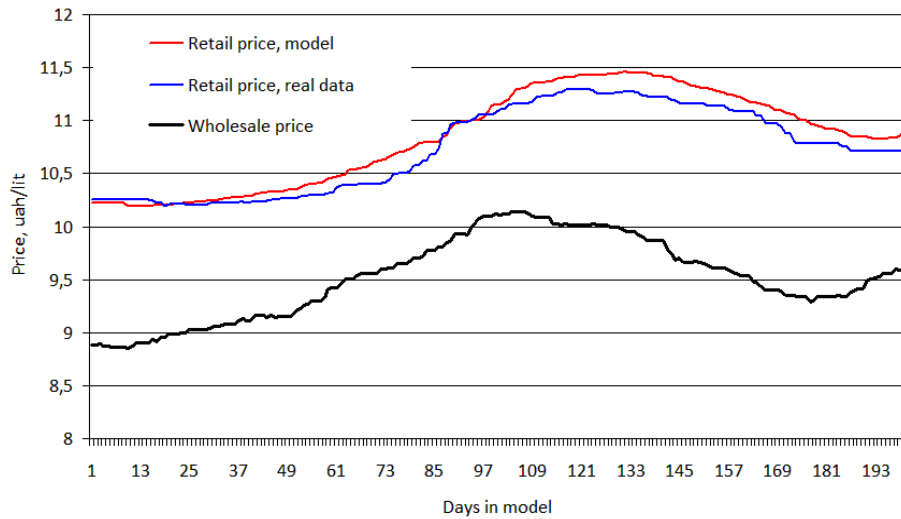

Fig. 9. Comparison of real and model average retail prices.

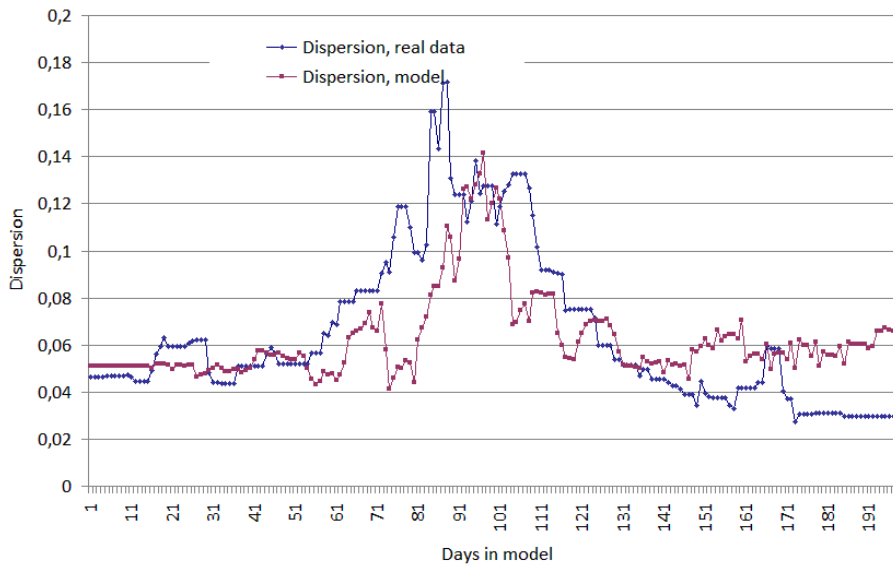

Fig. 10. Comparison of real and model dispersion of retail prices.

Along with the calibration of the model of the dynamics of the dispersion of retail prices with the use of the algorithm for searching the base price for consumers, the possibility of forming adequate dispersion estimation for other types of consumer behaviour was also checked. In Fig. 11 shows a comparison of the dynamics of retail price dispersion by various consumer behaviour algorithms. Other patterns of consumer behaviour have a fundamentally different dynamics of dispersion. In cases of search and price targeting, almost the same growth of dispersion is observed during the growth of retail prices. However, in the case of price-targeting, the dispersion, and somewhat lowered while finding retail prices for the “plateau”, began to increase again after falling prices. On the one hand, this testifies to the discrepancy of such behaviour with real situations. However, on the other hand, there may be a simple non-compliance of the rules of retail networks with a similar behaviour of consumers. It should be noted that the re-training of the model with the use of the algorithm of targeting the price was not carried out, because the replacement of the algorithm has a small effect on the dynamics of average prices. The dynamics of dispersion in the use of consumers without a search showed that such a type of consumers cannot be dominant in the market given the significant difference in dispersion from the real.

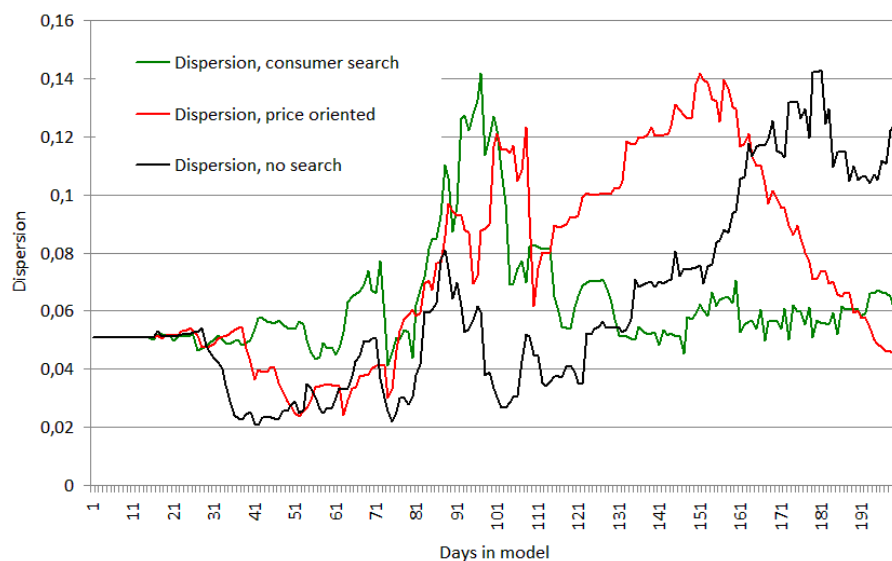

Fig. 11. Comparison of dynamics of dispersion of retail prices for various consumer behavioral algorithms.

6 Conclusions

This paper proposes a multiagent model of the phenomenon of dispersion of prices in the market of petroleum products. The conducted research showed that the multiagent model of oil products market as an oligopolistic competitive environment, in which fuel

consumers are guided by the strategy of price search, generates the phenomenon of the price variance regardless of the initial conditions of the variance values. The agents' interaction was based on oligopolistic competition rules and consumer price search strategies. This model was tested on the price data for gasoline in the Kyiv region of the Ukrainian oil market. The choice of data for this region and the choice of gasoline as a commodity were dictated by the desire to identify the effect of dispersion due to the existence of a search strategy for consumers on a market with a homogeneous product. At the same time, the existence of a dispersion of retail prices in the market of petroleum products has been shown as a result of oligopolistic competition of traders and price search behavior of buyers, as well as the growth of price dispersion at price jumps of wholesale prices. It is shown well enough to predict the appearance of this pattern at price jumps. It has been established that the best approach to real data, both in terms of price and dispersion, has been shown by the consumer strategy with the search for the base price. The availability of other search strategies has not been confirmed. Comparison of model calculations and real data showed a fairly satisfactory coincidence, which, however, needs to be improved. However, to do this, there is need to conduct additional research in mixed search strategies for different categories of users.

References

1. Stigler, G.: The economics of information. *The J. of Polit. Econ.* **69**(3), 213–225 (1961)
2. Diamond, P.: A model of price adjustment. *J. of Econ. Theory.* **3**(2), 156–168 (1971)
3. Stiglitz, J.E.: Equilibrium in product markets with imperfect information. *Am. Econ. Rev.* **69**(2), 339–345 (1979)
4. Varian, H.: A model of sales. *Am. Econ. Rev.* **70**(4), 651–659 (1980)
5. Lach, S.: Existence And Persistence Of Price Dispersion: An Empirical Analysis. *The Rev. of Econ. and Stat.* **84**(3), 433–444 (2002)
6. Barron, J.M., Taylor, B.A., Umbeck, J.R.: Number of sellers, average prices, and price dispersion. *Int. J. of Ind. Org.* **22**(8-9), 1041–1066 (2004)
7. Baye, M.R., Morgan, J., Scholten, P. P.: Price Dispersion in The Small And in The Large: Evidence From An Internet Price Comparison Site. *J. of Ind. Econ.* **52**(4), 463–496 (2004)
8. Lewis, M.: Price Dispersion and Competition with Differentiated Sellers. *J. of Ind. Econ.* **56**(3), 654–678 (2008)
9. Lach, S., Moraga González, J.L.: Asymmetric price effects of competition. *J. of Ind. Econ.* **65**(4), 767–803 (2017)
10. Chandra, A., Tappata, M.: Consumer search and dynamic price dispersion: an application to gasoline markets. *The RAND J. of Econ.* **42**(4), 681–704 (2011)
11. Rossi, F., Chintagunta, P.: Price transparency and retail prices: Evidence from fuel price signs in the Italian highway system. *J. of Mark. Res.* **53.3**, 407–423 (2018)
12. Noel, M.: Gasoline Price Dispersion and Consumer Search: Evidence from a Natural Experiment. *J. of Ind. Econ.* **66**(3), 701–738 (2018)
13. Heppenstall, A.: Using Hybrid Agent-Based Systems to Model Spatially-Influenced Retail Markets. *J. of Art. Societ. and Soc. Sim.* **9**(3) (2006)
14. Ramezani, S., Bosman, P. A., & La Poutré, H.: Adaptive Strategies for Dynamic Pricing Agents. In: *Proceedings of the 2011 IEEE/WIC/ACM International Conferences on Web Intelligence and Intelligent Agent Technology*, volume 02. IEEE Computer Society (2011)

15. Levin, Y., McGill, J., Nediak, M.: Dynamic Pricing in the Presence of Strategic Consumers and Oligopolistic Competition. *Man. Sci.* **55**(1), 32–46 (2009)
16. Galchynsky, L., Svydenko, A.: The Asymmetry of Price in the Petroleum Products Market of Ukraine. *Brit. J. of Econ., Man. & Trade.* **13**(3), 1–14 (2016)
17. Galchynsky, L., Svydenko, A.: Multiagent model of prices dispersion on the retail market of petroleum products. *SHS Web of Conferences.* **65**, 04021 (2019). DOI:10.1051/shsconf/20196504021

Ukraine's Exports as a Global Challenge for Its Future

Sergii Sardak^[0000-0002-4716-3355]

Oles Honchar Dnipro National University, Department of Economics, Entrepreneurship, and Management of Enterprises, 72, Gagarin Ave., Dnipro, 49010, Ukraine
dnus@ukr.net

Svitlana Radziyevska^[0000-0002-3680-7952]

The State University of Infrastructure and Technology, Department for Theoretical and Applied Economics, 9, Kyrylivska Str., Kyiv, 04080, Ukraine
svitrad98@ukr.net

Ivan Us

The National Institute for Strategic Studies, Department of Foreign Economic Policy, 7-a, Pyrogova Str., Kyiv, 01030, Ukraine
ivanusus@gmail.com

Abstract. Exports are critical for the highly open Ukrainian economy which is characterized by the large trade deficit. Since independence the major consumers of the Ukrainian products have been the CIS and the EU. Conflict with Russia led to the significant decline of the volume of Ukraine's export commodities. The export analysis, based on the data provided by the State Statistics Service of Ukraine for the period of 2010-2018 allowed to identify the problems and to come up with possible solutions focusing primarily on the role of the Government of Ukraine in strengthening cooperation with the EU. Firstly, it is suggested to take the institutional steps aimed at expanding and deepening the integration towards the common economic space with the EU, especially the common customs space. Secondly, to explore the opportunities of exporting goods to the countries, with which the EU has signed regional trade agreements. The third step is related to the changing role of Ukraine in the global model of the transformation of the world economy and requires the combination of close cooperation with the EU, on the one hand, and the powerful economies, on the other, thereby contributing to the formation of non-confrontational relations between East and West.

Keywords: exports, Free Trade Agreement, integration, common customs space, model of global transformation.

1 Introduction

The high-level openness of the economy makes Ukraine very vulnerable to the impact of strengthening global economic and integration processes [1, 2, 3].

Since independence Ukraine had been balancing in terms of its integration aspirations between Russia and the European Union (EU) up until 2014 [4]. The global crisis of 2008-2009 challenged the trade, but the geopolitical conflict of 2014 brought about much more difficult time for the whole country, resulting in the transformations of the major trade flows of Ukraine [5].

Russia's trade wars, an embargo on agricultural products, the termination of free trade agreement (FTA) in January 2016 hit the Ukrainian economy hard, led to the sharp decrease in bilateral trade and the significant decline of the volume of deliveries of Ukraine's main export commodities, among them the goods with high- added value. The conflict with Russia also hindered the country's transport and transit potentials, preventing trade with neighboring states.

So, the future of Ukraine has become dependent on its trade relations with the EU and the countries which could compensate for Ukraine's loss of the Russian market. The severe economic situation is pushing Ukraine towards surviving by promoting goods not only on the markets of Central and Eastern Europe, but also on those of Asia and Africa. The priority issue for Ukraine today is to re-orient its exports and avoid the trap of being a raw materials export economy [6].

The objective of the paper is to suggest the ways to promote exports of goods of Ukraine by improving trade relations with the EU, the Commonwealth of Independent States (CIS) and the other old partners, as well as by capturing new markets in Asia and Africa, and building relations with the leading countries on the East as a means of strengthening the economy of Ukraine in order to find its place in the global model of the transformation of the world economy. This task is significant, as increased exports of goods will generate many benefits to the Ukrainian economy which has been in the devastating economic situation since the global crisis.

2 Ukraine's Free Trade Agreements and Multi-vector Trade Policy

In the 1990s young independent Ukrainian state practiced multi-vector international economic policy. On the one hand, Ukraine maintained the old trade relations with the former USSR republics and participated in the integration processes in the framework of the CIS, Single Economic Space, The Eurasian Economic Union (EAEU) and, on the other hand, Ukraine declared its interest in joining the EU and started building new trade relations with prospective countries all over the world. In the literature of the field, it is emphasized that regional integration is essential to maximizing the benefits of globalization for the Least Developed Countries (LDCs) since it has the potential to attract investment flows, expand market size, develop regional infrastructure and connectivity [7].

Let's review Ukraine's milestones in terms of FTAs, entered into force. Focusing on Ukraine's trade with the eastern partners, it's necessary to state that right after obtaining independence in 1991 Ukraine signed the Agreement establishing the CIS along with Russia and Belarus. The heads of eleven former Soviet Republics (except Georgia and the Baltic states) signed the amendment to the Agreement founding the CIS on

December 21, 1991. On October 18, 2011 the FTA was signed by eight countries: Armenia, Belarus, Kyrgyzstan, Kazakhstan, Moldova, Tajikistan, Russia and Ukraine, it entered into force on September 20, 2012. Azerbaijan and Turkmenistan did not sign the Agreement, while Uzbekistan joined it later, in 2012.

According to the Regional Trade Agreements (RTAs) database of the World Trade Organization, Ukraine has signed the following FTAs with the CIS countries: Turkmenistan (entered into force on November 4, 1995), Uzbekistan (January 1, 1996), Georgia (June 4, 1996), Azerbaijan (September 2, 1996), Armenia (December 18, 1996), Kyrgyzstan (March 20, 1998), Kazakhstan (October 19, 1998), Tajikistan (July 11, 2002), Moldova (May 19, 2005), Belarus (November 11, 2006) [8]. Also Ukraine has signed FTA with the countries of the Single Economic Space (Belarus, Kazakhstan, Russian Federation) which entered into force on May 20, 2004, and with the Organization for Democracy and Economic Development (Georgia, Ukraine, Azerbaijan, Moldova – GUAM) which entered into force on December 10, 2003.

Considering Ukraine's efforts towards strengthening relations in the western direction, it's worth mentioning that the first EU-Ukraine top-level meeting was held on September 14, 1992 and was followed by the Agreement between the European Communities and Ukraine on trade in textile products, signed on May 5, 1993 and the Agreement on Partnership and Cooperation between Ukraine and the EU, signed on June 14, 1994. The year 1998 should be highlighted since the President of Ukraine Leonid Kuchma in June signed the Decree 615 approving the Strategy of Ukraine's integration to the EU. On February 18, 2008 the FTA negotiations were launched [9]. Ukraine signed FTA with Macedonia (entered into force on July 5, 2001), the European Free Trade Association (EFTA), consisting of Switzerland, Norway, Liechtenstein, Iceland (entered into force on June 1, 2012), Montenegro (January 1, 2013), Canada (August 1, 2017). Finally, the FTA with Israel was signed in January 2019.

However, in 2013 the president of Ukraine Victor Yanukovich did not sign the Association Agreement, planned for November 2013, which led to the Revolution, the overthrow of the government and Russia's aggression against Ukraine. Hence, in 2014 the Association Agreement was signed, including its Deep and Comprehensive Free Trade Area (DCFTA) part. The DCFTA entered into force on April 23, 2014.

It should be noted that Ukraine indeed had been invited to join the EAEU for a few years. The EAEU was eventually established in January 2015, the member states are the Republic of Armenia, the Republic of Belarus, the Republic of Kazakhstan, the Kyrgyz Republic and the Russian Federation. In January 2010, the Customs Union of Belarus, Kazakhstan and Russia was launched: the Common Customs Tariff was implemented, customs formalities and customs control at the internal borders were cancelled, and free movement of goods within the three states was ensured [10]. If Ukraine were to join the Customs Union, it would have no choice but to terminate all its existing FTAs with other countries, including the one with the EU under the Agreement. If, on the other hand, Ukraine wanted to maintain independent preferential trade relations with both the EU and the Customs Union, this would still be possible, through the establishment of Free Trade Areas. The Agreement was meant to do just that: to leave Ukraine free to determine its own trade policy [11].

To sum up, Ukraine has concluded 19 FTAs (EU, CIS, EFTA, GUAM, Canada, Georgia, Montenegro, Macedonia, Israel) covering 46 countries with over 810 million potential consumers of the Ukrainian products. The talks have begun on signing FTAs with Turkey and Serbia.

3 Ukraine's Exports of Goods as the Key to Economic Growth

Exports are of highest priority for open Ukrainian economy and remain the driving force of economic growth of the country. According to the World Bank, in 2017 exports of goods and services are 47.95% of GDP [12]. One of the key peculiarities of the economy is that the share of trade in goods in all trade in goods and services makes up for more than 80%, e.g. 81.5% in 2015; 80.6% in 2016; 82.3% in 2017.

A closer look at Ukraine's export performance during the period between 2010 and 2018 shows that there are three problems which need to be solved.

The first problem for Ukraine in foreign trade relations is the large trade deficit, which in goods reached 9.801 billion dollars in 2018, the result of great surplus of high value-added imports of goods over exports comprised by agriculture, metals and other low value goods. The balance of trade in goods has been negative since 2005, except for 2015 when it was positive of 610.7 million dollars [13].

The second problem is the significant decline in the volume of export commodities. The tendency towards the reduction of Ukraine's exports in products remains on the agenda since the post-crisis period (with total exports of 50744.3 million dollars for 2010 and 47339.9 million dollars for 2018).

The linear regression trend model of the relationship between the two variables – the time and the size of goods produced for exports is calculated by the method of least squares. The results presented in the tables are based on the Microsoft Excel program. The pair linear regression is applied in the research.

The models enable, firstly, the economic interpretation in terms of positive or negative dynamics of the goods exported over the analyzed period of time and, secondly, the analysis of the current economic situation, as well as the suggestions on the ways for its improvement. Table 1 indicates that the trend of the volume of exports of goods for the period of 2010–2018 is $y = -2893x + 66404$. To confront the problem, the Cabinet of Ministers of Ukraine adopted the Program on active promotion of export of goods and the strengthening of the domestic market. The Program was approved by the Cabinet of Ministers of Ukraine on December 11, 2014 and aimed at doubling the total exports by 2019, it also presupposed conclusion of FTAs with Canada, Turkey, Israel, and two regional integration organizations – The Cooperation Council for the Arab States of the Gulf (originally known as the Gulf Cooperation Council – GCC), the Economic Community of West African States – ECOWAS) [14]. As of today, referring to the program, Ukraine has concluded FTAs with Canada and Israel, but failed to increase exports and to conclude the other planned FTAs.

Moreover, in the 2017 President's Annual Address to the Parliament of Ukraine it was stated that Ukraine should strengthen its trade relations and cooperation with the regional organizations, especially those located in Asia, among them Association of

Southeast Asian Nations (ASEAN) and the Shanghai Cooperation Organization (SCO) since they play important roles in politics, security, finance, and economy on the global level [15]. The Deputy Minister of Agrarian Policy and Food of Ukraine for European Integration Vladyslava Rutytska confirmed Ukraine's interests in signing FTA with ASEAN. Interestingly, after the global crisis the U.S. managed to double exports in 2010 reaching the goal, declared in the National Export Initiative (NEI). It is important to stress that the Government played the key role: the Export Promotion Cabinet was created, twenty agencies were working under the Trade Promotion Coordinating Committee; the National Export Strategy links the NEI and the export promotion strategy of the U.S. Government [16]. The American experience shows that exports contribute to the growth of GDP, support millions of high-paying jobs in the U.S.; have been responsible for major contributions to the economic performance of many states and metropolitan areas [17].

Table 1. Ukraine's exports of goods in million dollars, 2010-2018.

	2010	2011	2012	2013	2014	2015	2016	2017	2018	Trends 2010-2018
Total	50744.3	67594.1	67779.8	62305.9	53901.7	38127.1	36361.7	43264.7	47339.9	$y=-2893x+66404$
EU	12916.4	17862.9	16937.9	16573.5	17002.9	13015.2	13496.3	17533.4	20158.5	$y=292.3x+14705$
CIS	18482.9	25835.8	24911.3	21672.1	14882.3	7806.1	6031.5	6916.4	7027.0	$y=-2570x+27691$

Source: authors' calculations, based on *the State Statistics Service of Ukraine* database. <http://www.ukrstat.gov.ua> (2018) Accessed 19 Mar 2019.

The analysis of the Ukrainian exports demonstrates that in 2017 Ukraine exported goods to over 200 countries. The main consumers are the EU and the CIS. As shown in table 1, there is a tendency of a great decrease in volumes of the total Ukrainian commodity exports, and especially exports of goods to the CIS while the key export market for goods has become the EU.

The third problem is low-tech exports. Ukraine is the world's fifth largest exporter of cereals and a major exporter of iron and steel. In 2017, the main exported products were sunflower seeds, maize, wheat and meslin, iron products, soya beans and colza seeds. The main imported products were fuels, vehicles, medicines, pesticides and fertilizers, machinery [3]. The researchers emphasize that as many as 38 developing countries are estimated to be dependent on a single commodity for more than 50% of their export income, while 48 countries, many of which are LDCs, depend on only two. Over the past 40 years, real prices for many of the agricultural commodities on which LDCs depend have fluctuated widely and fallen significantly overall [7]. Ukraine finds itself in the similar situation since nearly 60% of the exports of goods are raw materials: over 40% are agricultural products and more than 20% - steel. Consequently, we should agree with the scholars who argue that foreign trade of Ukraine has no effect on the improvement of innovation of the country [18], and it sounds logical that the positive impact of the export shock on innovation is magnified for high productivity firms, whereas it may negatively affect innovation in low productivity firms [19]. To tackle the third problem on December 27, 2017 the Government approved the Export Strategy of Ukraine: Roadmap for Strategic Development of Trade for the period of 2017-2021, which was developed by the Ministry of Economic Development and Trade with the

assistance of the business and experts based on the methodology of the International Trade Center. The Strategy states that with an overall vision of moving Ukraine into “Knowledge- and innovation-based exports for sustainable development and success in global markets” [20].

In this respect another big challenge is that foreign markets are quite segmented for Ukrainian exports as machine-building products are orientated mainly towards post-Soviet markets, and the Russian Federation in particular, while exports to European markets constituted mostly of low value-added goods [20]. The current state of exports of Ukraine is characterized by significant changes in the dynamics of its volumes, commodity structure, geography of consumers. An analytical paper released by the National Bank of Ukraine suggests that the regional and commodity structure of Ukraine’s external trade has undergone drastic changes over the last decade in response to global commodity market and geopolitical developments [21]. Thus, the overview of foreign trade performance of Ukraine for 2010-2018, based on the analysis of the data of the State Statistics Service of Ukraine, proves that it is important to focus on increasing not only the volume of exports of goods, but also the share of high-tech products in them in order to have a positive trade balance.

The Government of Ukraine, through the Ministries, and business elite of the country should work on signing RTAs with eastern partners and take the responsibility for solving the above mentioned three problems. In our opinion, the best way for promoting exports is the combination of Ukraine’s close cooperation with the EU, on the one hand, and the powerful economies of the world, on the other, which will not only contribute to the formation of non-confrontational relations between East and West, but also will strengthen foreign trade of Ukraine and its integration into the global space.

4 Ukraine and the EU

Over the past five years, the importance of the EU market for Ukraine has significantly increased.

4.1 Trade Between Ukraine and the EU in 2018

According to the results of 2018, its share in the geographical structure of both exports and imports of goods amounted to 43%. Since April 2014, that is, since the introduction of temporary trade preferences for Ukraine, the EU has canceled most of the duties on Ukrainian goods. An exception has been made to the number of individual items such as wheat, maize, poultry, and others, mainly agricultural products for which there is a quotas mechanism, as well as several groups of products in the processing industry, such as vehicles (primarily cars), receiving equipment for radio broadcasting, certain types of weapons and other goods for which transitional periods (preferably 7 years) have been established until the cancellation of duties. This contributed to a gradual increase in exports of goods from Ukraine to the EU by 3.6% in 2016 and by 29.9% – in 2017.

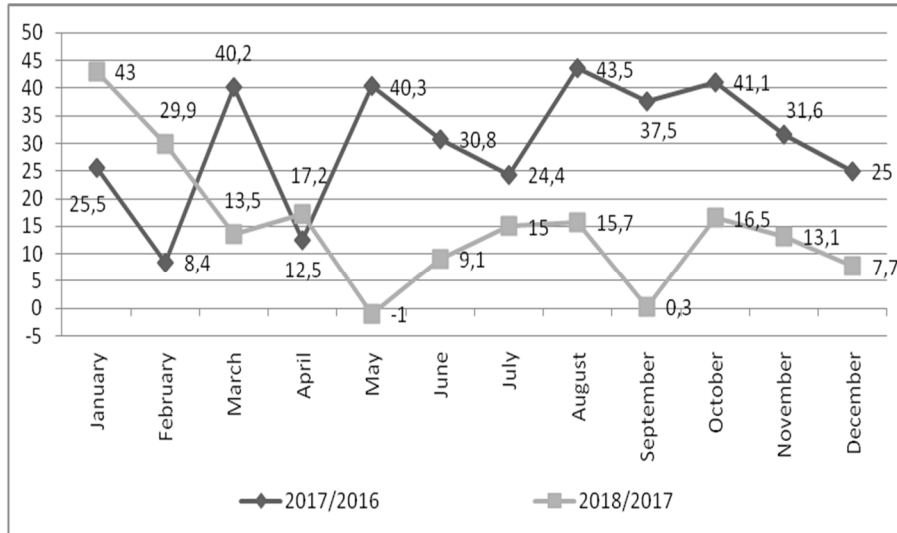

Fig. 1 Monthly dynamics of exports of goods from Ukraine to the EU in 2017 and 2018 (in % to the corresponding month of the previous year. Source: authors' calculations, based on *the State Fiscal Service of Ukraine* database. <http://sfs.gov.ua/ms/fl> (2018) Accessed 10 Mar 2019.

The trend of export supply expansion continued in 2018 (exports increased by 15%). In the middle of 2018 export growth rate slowed considerably (in May 2018 compared to May 2017 exports of goods even declined by 1%), while the average growth rate of exports in the monthly dynamics is significantly lower than in 2017 (Figure 1).

The sectoral analysis of the goods export dynamics to the EU shows that the lower growth of export volumes in comparison with the previous year can be explained by the relatively modest growth rates of export of agricultural products (by 9%, while by the end of 2017 this indicator was 40.1%), the share of which in the commodity structure of exports to the EU is almost 26% (Figure 2). A similar situation was observed in some other sectors. Thus, exports of food products grew by 5.7%, while last year growth was 22.9%. Exports of machine-building industry goods increased by 14.7% versus 25.3% in 2017, while the export of transport equipment increased by almost 1%, although in 2017 it grew by 30.2%.

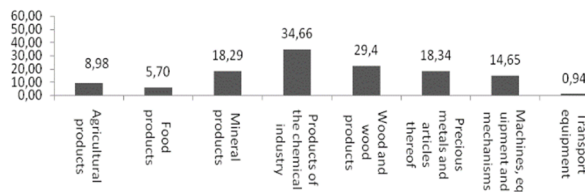

Fig. 2. Dynamics of export of commodity groups from Ukraine to the EU in 2018 compared to 2017. Source: authors' calculations, based on *the State Statistics Service of Ukraine* database. <http://www.ukrstat.gov.ua> (2018) Accessed 19 Mar 2019.

The given statistics allows us to conclude that Ukraine has almost fully used the possibilities, it has been provided with, regarding abolishment and reduction of customs duties, and now in order to further increase exports, it is necessary to take additional measures, both in terms of expanding already existing opportunities and implementing new initiatives.

4.2 Improvement of Customs Procedures

First of all, it is important to reduce the time and money costs when crossing the customs border with the EU and changing the volume and approaches to administering the tariff quotas provided by the EU.

Measures to reduce the costs of domestic exporters while delivering goods to the EU may become an important step for Ukraine to expand exports to the EU. Special attention should be paid to minimizing costs when crossing the EU customs border which requires harmonization of control measures carried out by the customs authorities of Ukraine and the EU, aimed at elaboration of the common approach to the customs control, the results of which will be recognized on both sides of the border.

As we can see, the steps require additional efforts from Ukraine with the focus on the following issues:

1. *Harmonization of customs legislation* which is a prerequisite for the implementation of all the measures aimed at simplifying the crossing of the EU customs border. To achieve this, Ukraine should finish with:
 - Implementation of the EU Customs Code (UCC) and other EU acquis in the customs field;
 - Harmonization of the Ukrainian Customs Tariff structure and the product nomenclature with those of the EU;
 - Unification of the practice of applying customs legislation by the customs authorities of Ukraine and the EU.
2. *Mutual Recognition of Authorized Economic Operators*. The result should be simplification of customs procedures in the EU for Ukrainian enterprises that have received the status of an authorized economic operator from the Ukrainian customs authorities. That is, having, for example, the privilege of primary customs clearance in Ukraine, such an enterprise will automatically use the same simplifications for customs clearance in the EU. To achieve this, Ukraine should:
 - Introduce changes to the legislation and subordinate normative legal acts in the field of regulating the activities of the authorized economic operators (AEO).
 - Negotiate with the EU on the terms of the agreement on the recognition of AEOs. Also, diplomatic channels should stimulate the EU to similar negotiations with Ukraine.
3. *Accession of Ukraine to the European Customs Information System (New Customs Transit System – NCTS)*. Accession of Ukraine to NCTS should lead to significant simplification of import-export procedures, as the customs authorities of the two

parties will exchange a significant amount of information in electronic customs declarations. This will accelerate border control, since there will be no need to fill out new transit declarations on the opposite side of the border. To achieve this, Ukraine should:

- Make changes to the legislation of Ukraine regarding the use of a common transit system with the EU;
- Fulfill the technical requirements necessary for integrating Ukraine into the European transit system.
- Negotiate with the EU for the purpose of obtaining the invitation for Ukraine to accede to the NCTS Convention.

4. *Introduction of paperless customs environment.* Exchange of electronic documents other than customs declarations (for example, between the EU and the European Free Trade Association, electronic exchange of information through more than 200 standardized electronic documents is implemented) can significantly facilitate the free movement of goods. Distribution of electronic exchange on such documents as, for example, certificates of origin, electronic invoices, cargo documents, etc., will lead to considerable time savings during customs clearance both in the EU and in Ukraine. To achieve this, Ukraine should:

- Establish technical procedures for the exchange of information on issued certificates of origin and the numbers of approved exporters;
- Amend the legislation regarding the possibility of using electronic documents received from customs authorities of foreign states;
- Extend control elements based on the “one-stop shop” principle based on a single EU–Ukraine information system;
- Sign an agreement on informational interaction between the customs authorities of Ukraine and the EU.

5. *Mutual recognition of the results of some forms of customs control (results of weighing, scanning, etc.).* Customs controls are carried out on both sides of the border, for example, a customs inspection (which, as a rule, takes the most time among all measures), can be carried out both when exporting goods from Ukraine and when importing them into the EU. Establishing proper trust between the customs authorities and exchanging information on the control forms will eliminate the duplication of control forms and the loss of time associated with it. To achieve this, Ukraine should:

- Coordinate the technical issues of information exchange and the extent of customs control, the results of which are recognized by an adjacent party.
- Amend the legislation in terms of applying the results of the customs control carried out by the European Authorities for improving the customs control in Ukraine.
- Sign an agreement on informational interaction between the customs authorities of Ukraine and the EU.

Bills aimed at confronting the above mentioned issues are already under consideration of the Parliament of Ukraine.

The need to support these bills is set out in the European Union Report on the implementation of the Association Agreement between Ukraine and the EU in 2017. This document was prepared by the European External Action Service and the European Commission for the annual meeting of the Association Council of Ukraine and the EU on December 17, 2018 in Brussels.

4.3 Increase of the EU Tariff Quotas for Goods from Ukraine

With regard to expanding existing export possibilities to the EU, it is expedient to intensify the dialogue with the EU on the use of tariff quotas set for Ukraine for certain types of products and to create a commission (working group) on a regular basis with the purpose of monitoring the use of tariff quotas and introducing proposals on providing Ukraine with additional quotas for those products for which the EU demand significantly exceeds the established volume of tariff quota. In accordance with the Appendix to Annex I-A of Section IV of the Association Agreement, the EU has introduced for certain goods tariff quotas that provide for a zero import duty rate within the quota and non-zero outside the quota. The list of EU tariff quotas has 36 positions (four of them were granted additional quotas, which actually increased the number of tariff quotas to 40) and mainly contains products of agriculture and food industry.

Administration of tariff quotas is carried out by the European Commission, and the quotas themselves are divided into those given on the basis of the “first come – first received” principle (provided by the Directorate General of Taxation and Customs Union in accordance with Annex II to Regulation (EU) No. 374/2014), and those given under the “import licenses” (provided by the Directorate General for Agriculture in accordance with Annex III to Regulation (EU) No. 374/2014). In both cases, the certificates EUR.1 is a must for using quotas.

The Ukrainian Government and the producers can not directly influence the process of distribution of tariff quotas since in accordance with the established procedure, the initiators of the use of these tariff quotas are the importing companies in the EU countries, which have the right to submit their applications for import to their governments. Subsequently, such applications are sent to the European Commission for registration. Thus, the task of the Ukrainian sellers is to find a potential buyer in the EU that could organize the filing of the relevant application, and the task for the Ukrainian Government is to create the most favorable conditions for domestic producers to find potential buyers. In this regard, in particular, it is desirable to create a database of potential buyers, which will simplify for domestic producers the process of finding business partners in the EU. Special attention should be paid to those commodity positions on which the request for domestic products by the EU member states substantially exceeds the size of the established annual quotas.

The request of EU Member States for domestic corn is more than 50 times the size of the established quota. The request for wheat under the basic quota exceeds the established size 37 times, and for an additional quota – 46 times. Moreover, there is a significant surplus of the EU Member States' request for butter and dairy pastes and

poultry from Ukraine. At the same time, a certain obstacle to the use of quotas for these two items is their breakdown for half a year (in the case of butter and dairy pastes) and quarter (for poultry). Thus, the request of the EU countries for an additional quarterly quota for poultry in the first quarter of 2018 amounted to more than 21 thousand tonnes at its volume of 5 thousand tonnes, and for the fourth quarter of 2018 the request was 41 tonnes at the unused balance and a new quarterly quota of 8202 tonnes. Hence, the unused volume of the quota was 8161 tonnes. At that time, there were no queries at all for three quotas (for beef and two for pork). Similar situation is observed with the annual quotas provided on the basis of the “first come – first received”. Certain annual quotas were used in the first months of the year (quotas for honey and juices in 2018 were fully exhausted on January 10, 2018), indicating the need for their increase, while exports were not started in eight quotas.

It becomes clear that there is a need both for increasing the size of quotas and for improving their administration. Achievement of this goal requires mathematical calculations followed by the negotiations with the EU. Priority issue for the expansion of the export of domestic goods to the EU is the promotion of the interests of the Ukrainian exporters in the EU institutions, primarily for the purpose of defending their interests instead of accusing them of violating the trade rules established by the Association Agreement between Ukraine and the EU. An example of this practice is the accusation made by some European partners of the domestic exporter of poultry meat (the company “Myronivsky Hliboprodukt”). The essence of the allegations was that the company opened a poultry meat processing company in the EU (in Slovakia) to produce packaged products for the final consumer from semi-finished products from Ukraine. It should be noted that this example is rather demonstrative, because from a legal point of view, the domestic exporter did not violate the established rules. The mentioned company has found opportunities to increase the supply of its products, which were not foreseen at the time of concluding the Agreement, and therefore could not contradict it. This situation necessitates the study of the practice of trade by Ukrainian exporters with the EU and finding opportunities to increase exports to this market.

In our opinion, the Ukrainian Government should defend Ukrainian companies against similar accusations using all possible formats, e.g. while holding the meetings of the Association Council of Ukraine and the EU.

The implementation of all above mentioned measures will significantly simplify the administration of trade between Ukraine and the EU and will contribute to increasing exports of the Ukrainian products to the EU.

5 Ukraine’s Exports During the Period Between 2015 and 2018 and the New Role in the Model of Global Transformation

The first way out to increase the Ukrainian export of goods is based on the unification of markets of the EU and Ukraine, establishment of a common customs system and synchronization of its operation. Since the EU market is restricted by quotas, some researchers argue that in order to minimize risks for the agrarian sector connected with

the DCFTA, leaders must improve the principles of an Euro-integration policy to accelerate works on the program of agro-industrial complex adjustment to operation under the conditions of the common European market and a common agrarian policy [23].

With regard to the exports of higher-value added products, according to the World Bank's Special Focus Note on international trade, Ukraine still has tremendous potential to boost them, but this potential has not yet been realized. The share of exports integrated with Global Value Chains (GVC) remains low at 5.7% in Ukraine, compared to 27% for Poland, 38% for Romania, 38% for Turkey, and 59% for Vietnam. Boosting higher-value added and GVC exports is a major opportunity for Ukraine to leverage its special access to the EU market. Ukraine has demonstrated potential on this front through the exports of automotive ignition wiring sets which grew from 21 million dollars in 2000 to 1.217 billion dollars in 2017, one of the fastest growing export product categories in recent years [12].

The second way for realization of the Ukrainian trade potential involves exploring opportunities of the export of goods to markets of the countries, with which the EU has signed RTAs, mainly in the form of FTAs. The EU continues to conclude FTAs with countries, as well as with regional integration blocs, strengthening its trade positions not only at the regional level, but also at the global level. The EU has concluded over forty FTAs with countries in Europe, Asia, North America, Latin America, the Caribbean and Africa while Ukraine is characterized by half the number of trade agreements.

The talks on strategic partnership between the EU and China were launched in 2013, FTA with Japan was signed in July 2018. The EU has intensified region-to-region negotiations on future FTA with ASEAN and MERCOSUR. At the same time the talks on strategic partnership with Brazil were launched on October 27, 2017. The EU experience and coordination in trade relations with these countries will be beneficial for Ukraine.

The third way is viewed as the main one and has the nature of the fundamental novelty since it is related to the changing role of Ukraine in the global model of the transformation of the world economy.

Let's have a look at the dynamics of volume of exports of goods of Ukraine to its main consumers during the period of 2015-2018 (Table 2).

The volume of total exports has increased, and the trend for the overall volume of exports is positive $y=3454x+32638$. Exports of goods to the EU are on rise – in 2015 they amounted for 13015.2 million dollars and in 2018 have grown to 20158.5 million dollars, bringing 7143.3 million dollars, which compensated for the losses of the Russian market since exports to Russia decreased by 1173.6 million dollars during the same period. So, some transformational shifts have already taken place. Trade with the CIS is slowly shrinking. There is also the tendency of export growth to Poland, Hungary, Romania, Czech Republic, Slovakia, the former members of the Council for Mutual Economic Assistance which could contribute to Ukraine's technological development. Germany, Italy, and Poland are also characterized by positive trends.

The most significant consumers of the Ukrainian products in Asia are Turkey (trend for 2015-2018 is $y=-78.82x+2620$), China ($y=-38.96x+2215$), and India

($y=249.8x+1307$) while the African vector of cooperation is represented by Egypt ($y=-200.3x+2834$).

Table 2. Dynamics of volume (in million dollars) and share (in %) of goods exports of Ukraine to its main consumers.

<i>Countries / volume trends</i>	2015	2016	2017	2018
Total	38127.1	36361.7	43264.7	47339.9
$y=3454x+32638$	100	100	100	100
EU	13015.2	13496.3	17533.4	20158.5
$y=2546x+9684.1$	34.1	37.1	40.5	42.6
CIS	7806.1	6031.5	6916.4	7027.0
$y=-145.2x+7308$	20.5	16.6	16.0	14.8
Russia	4827.7	3592.9	3936.5	3654.1
$y=-317.7x+4797$	12.7	9.9	9.1	7.7
Poland	1977.3	2200.0	2724.6	3257.6
$y=436.5x+1448$	5.2	6.1	6.3	6.9
Italy	1979.8	1929.6	2469.5	2628.8
$y=248.6x+1630$	5.19	5.3	5.7	5.6
Turkey	2771.8	2049.1	2519.1	2352.4
$y=-78.82x+2620$	7.27	5.64	5.82	5.0
Germany	1328.7	1423.7	1754.2	2208.4
$y=296.9x+936.3$	3.5	3.9	4.05	4.7
China	2399.1	1832.5	2039.3	2200.3
$y=-38.96x+2215$	6.3	5.0	4.7	4.6
India	1444.1	1903.1	2205.7	2175.9
$y=249.8x+1307$	3.8	5.2	5.1	4.6
Hungary $y=248.3x+613.1$	909.7	1053.1	1326.4	1646.3
	2.4	2.9	3.1	3.5
Egypt	2079.8	2266.5	1831.3	1557.1
$y=-200.3x+2834$	5.5	6.2	4.2	3.3
Belarus	870.7	903.2	1142.9	1304.5
$y=154.1x+570.0$	2.3	2.5	2.6	2.8
Romania	569.9	717.0	841.6	932.7
$y=121.3x+462.0$	1.5	2.0	1.94	2.0
Czech Republic	541.0	560.8	715.2	878.1
$y=116.5x+382.3$	1.4	1.54	1.65	1.9
Slovakia	468.5	471.4	656.0	864.2
$y=137.1x+272.1$	1.2	1.3	1.5	1.8

Source: authors' calculations, based on the *State Statistics Service of Ukraine* database. <http://www.ukrstat.gov.ua> (2018) Accessed 19 Mar 2019.

The three problems identified in the second section are becoming even more urgent since the total volume of exports of goods in 2018 has not still reached that of 2010, the trade deficit in goods was 6.3 billion dollars in 2017, and increased to 9.8 billion

dollars in 2018. Reforms to attract FDI should be implemented, the economy is to be integrated into GVCs. It is evident that Ukraine has large financing needs, since the IMF credits and state debts need to be paid back.

Experiencing sharp decrease in bilateral trade with Russia and still having doubts as to obtaining the status of the full member in the EU in the nearest future, Ukraine should be interested in concluding RTAs with the leading countries and regional integration organizations of the world, cooperation with which will allow Ukraine not only to increase exports of goods, but also to receive foreign direct investment ensuring innovation development path and technological leap. To sum up, Ukraine should improve trade relations with both – western and eastern partners.

6 Conclusions

For the first time in the scientific economic literature the development of the regional integration processes is viewed as a means of the consolidation of the world economy. Ukraine's integration processes, aimed at increasing the country's exports, play important role in consolidating West and East.

The Ukrainian Government should ensure support in the Parliament of Ukraine of bills aimed at fulfilling the terms of the EU-Association Agreement and access to the EU market, as well as address the President of Ukraine with a request for the determination of such bills as urgent. In addition, Ukraine's diplomatic missions in the EU countries should be set up to contract potential buyers of domestic products subject to tariff quotas, create an appropriate base for such buyers, as well as motivate them to appeal to their national authorities to provide tariff quotas to Ukraine.

The role of the Ukrainian Government is crucial not only for increasing the quantity of the products exports and improving their quality, but also for putting into practice the policies aimed at gaining full membership in the EU and considering new RTAs with the eastern countries. Ukraine should contribute to the formation of a new model of global transformation caused by the globalization processes. The novelty of the paper is the argumentation for Ukraine's integration with the EU, East Asia, and the Asia-Pacific region.

References

1. Radziewska, S.: Global economic processes and Ukraine. *International Economic Policy*. **1**(20), 74–98 (2014)
2. Sardak, S.: The life cycle of social and economic systems. *Marketing and Management of Innovations*. **1**, 157–169 (2016)
3. Societe Generale Business website: Country risk of Ukraine: international trade. <https://import-export.societegenerale.fr/en/country/ukraine/trade-country-risk> (2018). Accessed 20 Mar 2019
4. Sidenko, V.: Ukraine's export potential: the priorities of integration. In: UCEPS National Security and Defence, pp. 48–50. <https://core.ac.uk/download/pdf/11871754.pdf>. Accessed 20 Mar 2019

5. Makhinova, A., Mykuliak, V.: International trade in goods and services in Ukraine: overview. <https://sk.ua/wp-content/uploads/2018/12/International-trade-in-goods-and-services-in-Ukraine-overview.pdf> (2018). Accessed 20 Mar 2019
6. Kyslytska, A.: What are Ukraine's Export Priorities: the EU, CIS or Asia? June 21, 2018. Ukraine World. <https://ukraineworld.org/articles/russian-aggression/what-are-ukraines-export-priorities-eu-cis-or-asia> (2018). Accessed 20 Mar 2019
7. Pradhan, H. E., Malhotra, K.: Globalization and the Least Developed Countries: Issues in Trade and Investment. Round table on issues in trade and investment: Summary of discussions. UN Ministerial Conference of the Least Developed Countries "Making Globalization Work for the Least Developed Countries". UNCTAD and UNDP (2008)
8. World Trade Organization: The Regional trade agreements information system. <http://rtais.wto.org/UI/PublicAllRTAList.aspx> (2019). Accessed 19 Mar 2019
9. Delegation of the European Union to Ukraine: Relations with the EU. Economic and trade relations. Full chronology of EU-Ukraine relations. https://eeas.europa.eu/delegations/ukraine/1937/ukraine-and-eu_en (2019). Accessed 19 Mar 2019
10. Eurasian Economic Union. www.eaeunion.org (2019). Accessed 19 Mar 2019
11. European Commission: Myths about the EU – Ukraine Association Agreement. Setting the facts straight. http://trade.ec.europa.eu/doclib/docs/2014/january/tradoc_152074.pdf (2014). Accessed 19 Mar 2019
12. The World Bank: Export of goods and services. <http://data.worldbank.org> (2018). Accessed 19 Mar 2019
13. The State Statistics Service of Ukraine: <http://www.ukrstat.gov.ua> (2018). Accessed 10 Mar 2019
14. The Program of the Cabinet of Ministers of Ukraine. Resolution of the Parliament of Ukraine № 26-VIII dated December 11, 2014 <http://zakon4.rada.gov.ua/laws/show/26-19> (2014). Accessed 20 Mar 2019
15. Analytical report to the Annual Address of the President of Ukraine to the Parliament "On the internal and external state of Ukraine in 2017". National Institute for Strategic Studies (2017)
16. International Trade Administration. 2011 National Export Strategy. Powering the National Export Initiative. Trade Promotion Coordinating Committee, Washington, D.C. June 2011. <https://www.trade.gov/publications/pdfs/nes2011FINAL.pdf> (2011). Accessed 20 Mar 2019
17. Progress Report on the National Export Initiative. – Obama White House Archives. https://obamawhitehouse.archives.gov/sites/default/files/exports_progress_report.pdf. Accessed 25 Mar 2019
18. Butyter, D., Wachowska M.: Foreign trade and innovation: evidence from Ukraine. *Journal of International Studies*. **8**(1), 173–182 (2015)
19. Aghion, P., Bergeaud A., Lequien M., Melitz M.J.: The Impact of Exports on Innovation: Theory and Evidence. https://scholar.harvard.edu/files/aghion/files/impact_of_exports.pdf (2017). Accessed 25 Mar 2019
20. Export Strategy of Ukraine: Roadmap for Strategic Development of Trade for the period 2017-2021. <https://tinyurl.com/y3n3wk8o> (2017). Accessed 25 Mar 2019
21. National Bank of Ukraine: Recent NBU Research Suggests and Increasing Share of European and Asian Countries and a Decreasing Share of CIS Countries in Ukraine's External Trade. 15 June 2017. <https://tinyurl.com/y3tha6gw> (2017). Accessed 25 Mar 2019
22. State Fiscal Service of Ukraine: <http://sfs.gov.ua/ms/fl1> (2018). Accessed 10 Mar 2019

23. Yatsenko, O., Nitsenko, V., Karasova, N., James, H.S.Jr., Parcell, J.L.: Realization of the potential of the Ukraine–EU free trade area in agriculture. *Journal of International Studies*. **10**(2), 258–277 (2017). doi:10.14254/2071-8330.2017/10- 2/18
24. Sardak, S., Radziyevska, S., Us, I.: Exports of Ukraine as a global challenge for its future. *SHS Web of Conferences*. **65**, 09003 (2019). doi:10.1051/shsconf/20196509003

Modeling the Process of Counteracting Fraud in E-banking

Olga Syniavska^[0000-0002-7507-3541], Nadiya Dekhtyar^[0000-0001-7932-8620],
Olga Deyneka^[0000-0001-5852-4163], Tetiana Zhukova

Sumy State University, 2, Rymkoho-Korsakova Str., Sumy, 40000, Ukraine
{o.syniavska, n.dekhtiar, o.deineka}@uabs.sumdu.edu.ua,
gtanya@buh.sumdu.edu.ua

Olena Syniavska

Kharkiv National University of Internal Affairs, 27, Lev Landau Ave., Kharkiv, 61000, Ukraine
sinyavskaya.elen@gmail.com

Abstract. The paper is devoted to the current issue of the counteracting cyberattacks in the banking sector, in particular in the field of e-banking. The main types of banking fraud, which are carried out in the online sphere, are considered. The authors propose a mathematical model that describes the process of counteracting e-banking fraud. Proposed model is based on the classic Lotka-Volterra model with logistic growth and the Holling-Tanner dynamic models. The fixed points of a dynamic system were calculated and analyzed. It was determined that there are 4 possible types of fixed points: saddle and the line of stable fixed points, which are unlikely may be in real life, stable node and a stable degenerate node, which are, in practice, the most likely cases. The constructed model could be used for theoretical study, different simulation experiments with changing input parameters could be done. Unfortunately, it is difficult to investigate this question on real data, since the statistics on cyberattacks are closed.

Keywords: e-commerce, e-banking, fraud, e-banking fraud, fraudulent attack, cyberattack.

1 Introduction

The lack of proper attention to the security of online operations can make them vulnerable to criminals.

Today, most financial transactions are carried out via the Internet. The development of e-commerce has led to the fact that these trends have spread to the banking sector. Since the beginning of the 80's, the term "e-banking" has entered the economic terminology.

Due to the flow of funds through the Internet communication channels, fraudsters, who are coming up with more and more new cyberattacks schemes, have become more active. With the advent of new cyberattacks, new countering instruments are emerging.

The study of this issue, although it is relevant, but, unfortunately, is at a basic level. This is due to the fact that, in the first place, all information about cyberattacks that are carried out in the banking sector is confidential.

At the same time, it is theoretically and practically justified that the emergence of new fraudulent schemes leads to the development of new instruments to combat them. Thus, there is a kind of race that can go on forever.

Thus, scientists are faced with the task of studying the dynamics of the emergence of cyberattacks in the banking sector and the development of instruments of counteracting e-banking fraud. This article proposes to develop a mathematical model that would describe the process.

2 The Concept of E-banking

Innovative development of the economy of any country depends on the direction of society to the information space. Nowadays the main direction of innovation in the business is the transfer of commercial activity in the Internet space. Every year, from 30% to 70% of business in any country (regardless of its level of development) goes into on-line sphere. That is, companies are increasingly using e-commerce systems to conduct business.

The beginning of the Internet economy can be associated with the breakthrough of the World Wide Web system in the mid-1990s. Today, to describe economic relations on the Internet, the concept of “electronic commerce” is used, which is a part of the Internet economy. Thus, the Organization for Economic Cooperation and Development provides such definition of this term (in a broad sense): any form of business relationship where interaction between actors occurs using Internet technologies [1].

Finally, e-commerce could be defined as a relationship aimed at making a profit, carried out remotely using information and telecommunication systems, as a result of which participants have rights and obligations of a property nature [2].

In general, e-commerce is subdivided into: Electronic Data Interchange (EDI); Electronic Funds Transfer (EFT); e-trade; e-cash; e-marketing; e-insurance; and, finally, e-banking.

E-banking is a remote banking technology that gives the ability to receive banking services via the Internet [3]. To connect the client to the Internet banking system it is enough to have access to the global network, installed on the computer browser program, enter into a contract with the bank, get a set of passwords or special devices for logging in and operations, go to the secure page of the e-banking, sign up and connect to the system.

Traditionally, e-banking includes such operations: carry out banking operations on any computer connected to the Internet; pay for cable and satellite television, mobile communication operators, telephony; online games; to make utility payments; receive extracts about the movement of funds by card or account in the last few days, calendar

month, another arbitrary time period; open deposit; repay the loan; carry out transfer of funds between own accounts; various credit card transactions; view currency rates, bank announcements; submit applications for purchase / sale / currency conversion; blocking a card by a customer, for example, in case of theft or loss etc.

According to statistics, more than 80% of all banking operations can be done by a person sitting at a computer at home or at the office. Benefit from this kind of activity is received by all involved persons: clients of banks, banks, software developers and owners of companies representing their products and services on the Internet.

At the same time, the intensification of financial activities through the Internet leads to the fact that a large amount of personal information, including financial, passes through communication channels. This, in turn, leads to increasing e-banking fraud.

3 Types of E-banking Fraud

Nowadays, the development of various fraud schemes has reached a global level. In connection with the development of information technology, fraudsters are moving to a new level, organizing cyberattacks on automated systems of various companies and enterprises.

Cyberattacks penetrated absolutely all areas of business. The Fig. 1 shows 5 areas of business that have suffered the greatest costs due to cyber fraud in August 2018.

Fig. 1 shows that the most unprofitable cyberattacks were for the financial sector. At the same time, about 90% of the attacks fall on the banking sector. Especially active frauds are held in the field of electronic banking.

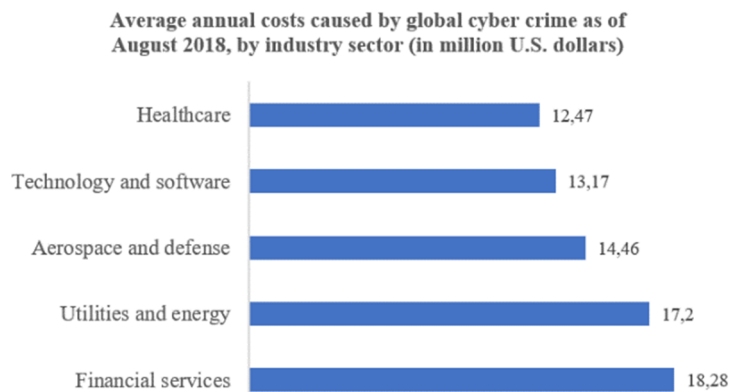

Fig. 1. Average annual costs caused by global cybercrime as of August 2018, by industry sector (in million U.S. dollars). [5]

The most common type of fraud in the e-banking sector today is phishing and its subspecies (Fig. 2).

Generally, phishing could be defined as a scalable act of deception whereby impersonation is used to obtain information from a target [4].

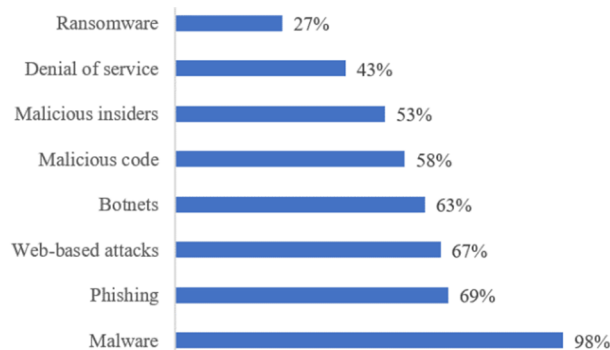

Fig. 2. Types of cyberattacks experienced by companies worldwide as of August 2018. [5]

More precisely, phishing is a form of social engineering in which an attacker, also known as a phisher, attempts to fraudulently retrieve legitimate users' confidential or sensitive credentials by mimicking electronic communications or phone calls from a trustworthy or public organization in an automated fashion [6].

In general, there are 2 basic phishing principles:

- on a mobile phone, sometimes not even tied to an account, the bell of a bank employee or even his security service rings. The client is told about the dubious movements on the card and is asked to call the CVV - the verification code of the card's payment system. You should never report anything, if the call was not made by the client himself by the support number, any information can be used for theft. It is better to interrupt the call and call your bank manager yourself;
- a letter comes to the client's mail, signed by its servicing bank. The link proposed in the letter leads to an analogue of a personal account in which you need to enter your login and password. Banks never use this way of working with clients, any letters to personal mail with a proposal to provide personal data, card number or enter the username and password, signed by an employee of the bank, is always sent to a fraudster.

A complete phishing attack involves three roles of phishers. Firstly, mailers send out a large number of fraudulent emails (usually through botnets), which direct users to fraudulent websites. Secondly, collectors set up fraudulent websites (usually hosted on compromised machines), which actively prompt users to provide confidential information. Finally, cashers use the confidential information to achieve a pay-out. Monetary exchanges often occur between those phishers [7]. The information flow is shown in Fig. 3.

Phishing can also be divided into such types depending on the mechanisms used:

- "Man-in-the-Middle" attack – hackers place themselves between banks and customers while customers are using their online banking accounts [8];
- deceptive phishing attack – sending false notifications through email [9]. In this type of phishing attack, an attacker sends email messages to users, masquerading as one of the bank's representatives [10].

- pharming – this method is more complicated and works only with small banks. Pharming is a type of attack intended to redirect traffic to a fake Internet host. There are different methods for pharming attacks, among which DNS cache poisoning is the most common [7]. Thus, the fraudster “replaces” the real Internet bank of the bank with the same visually, but fake, where the client enters his data, and the fraudster, respectively, receives all the necessary personal data.
- malware-based phishing – malware is a piece of software developed either for the purpose of harming a computing device or for deriving benefits from it to the detriment of its user [11]. Malware can be used to collect confidential information directly, or aid other phishing techniques.
- phishing through PDF Documents – some key functions of a PDF programming language could be misused by an attacker or a hacker to design a new PDF document to his/her own advantage and extract the desired personal information from the victim [7].

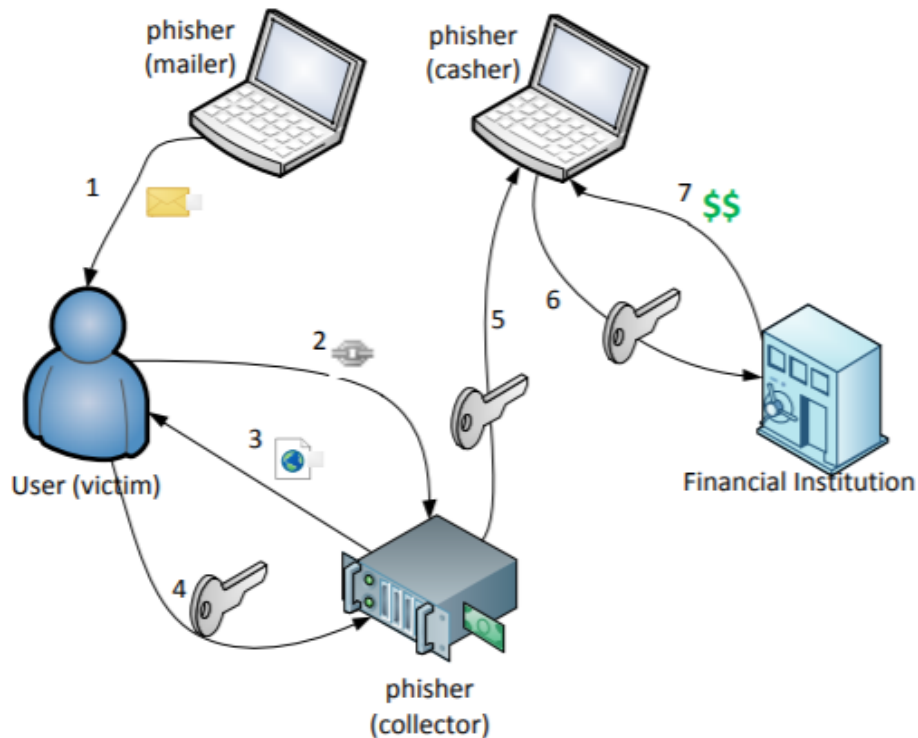

Fig. 3. Phishing information flow. [7]

Analysis of statistics on the total number of phishing attacks around the world shows that their number is gradually increasing (Fig. 4).

It may be noticed that the time series has a certain frequency. This is due to the fact that certain instruments of counteracting existing fraudulent attacks are created.

However, bypassing the emerging instruments, new types of attacks are created. Thus, the decrease in the number of phishing attacks due to the use of counteracting instruments is replaced by a sharp increase in their number.



Fig. 4. Number of global phishing attacks from 2012 to 2016 worldwide. [5]

Talking about payment systems that are most often subjected to phishing attacks, the statistics are shown in the Fig. 5.

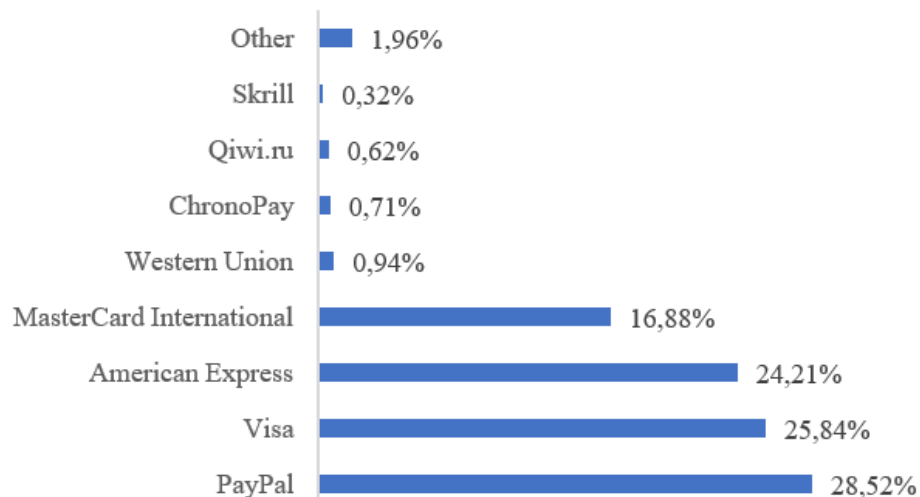

Fig. 5. Distribution of global phishing attacks aimed at online payment systems as of 4th quarter 2016. [5]

Thus, phishing is distinguished as the most common type of cyberattack in e-banking. Thus, further the mathematical model of counteracting similar bank fraudulent attacks will be proposed.

4 Mathematical Model of the Process of Counteracting Bank Fraud

Modeling a process of counteracting bank fraud is a complex issue in terms of collecting real data. The relevant statistics are closed. In addition, a huge number of fraudulent schemes does not reach the level of law enforcement agencies. Therefore, this question can be investigated in theoretical form.

This study proposes to simulate the process of counteracting bank fraud using a model of economic dynamics. So, the use of instruments to combat fraud and the emergence of new attacks can be compared to the classic “predator-prey” model [8].

$$\begin{cases} x' = (a - c \cdot y)x \\ y' = -(b + d \cdot x)y \end{cases} \quad (1)$$

where x – the number of prey;

y – the number of predators;

a, b, c, d – coefficients reflecting the interactions between species.

Suppose that for our subject area, x is the number of fraudulent attacks, and y is the number of instruments to combat bank fraudulent attacks.

The use of the Lotka-Volterra model with logistic growth [13] and the Holling-Tanner model [14] allows us to propose a model of counteracting bank frauds:

$$\begin{cases} x' = (a - d \cdot x - b \cdot y)x \\ y' = -c \cdot y + \frac{1}{b} - y \end{cases} \quad (2)$$

where x – number of fraudulent attacks at the time t ;

y – number of available tools to combat fraudulent attacks at the time t ;

a – the coefficient of natural increase in the number of fraudulent attacks;

b – the coefficient of effectiveness of one instrument of counteracting fraudulent attacks;

c – coefficient of natural decrease in the number of instruments of counteracting fraudulent attacks per time unit;

d – coefficient of interspecific competition for attackers. $d=1/D$, where D – the maximum possible number of attacks.

The next step is to find the fixed points of the system.

On the basis of symbolic calculations, we obtain two fixed points.

$$(x_1; y_1) = \left(0; \frac{1}{(1+c)b}\right) \quad (3)$$

$$(x_2; y_2) = \left(\frac{(1+c)a-1}{(1+c)d}; \frac{1}{(1+c)b}\right) \quad (4)$$

The study of the first fixed point is inappropriate from a practical point of view, since it is assumed that the number of fraudulent attacks equal 0. Therefore, we will investigate the second special point. We will linearize the model with Jacobian matrix.

$$J(x, y) = \begin{pmatrix} a - b \cdot y - 2 \cdot d \cdot x & -b \cdot x \\ 0 & -c - 1 \end{pmatrix} \quad (5)$$

We replace x and y in Jacobian with the values of the second fixed point and calculate the trace and determinant for the received matrix.

$$tr = a - c - \frac{2a+2ac-2}{c+1} - \frac{b}{b+bc} - 1 \quad (6)$$

$$\Delta = a + a \cdot c - 1 \quad (7)$$

Based on the analysis of characteristic regression, the following expression was obtained for the discriminant:

$$D = \left(c - a + \frac{b}{b+bc} + \frac{2d(a+ac-1)}{(1+c)d} + 1 \right)^2 - 4 \cdot a - 4 \cdot a \cdot c + 4 \quad (8)$$

Given the economic content of the input parameters of the proposed model, the discriminant can not be negative. Consequently, the roots of the characteristic equation can not be complex values. Moreover, given that the second root of the characteristic equation will always be a negative number, we can conclude that the roots of the characteristic equation can take the following values:

1. real, negative, different – fixed point type is stable node;
2. real, repeating, negative – fixed point type is stable degenerate node;
3. real, different, with different signs – fixed point type is saddle;
4. the first root is 0, the second is negative – fixed point type is a line of stable fixed points.

In order to achieve these types of fixed points we will form the constraints that must be imposed on the ratio of input parameters (Table 1).

Table 1. Type of fixed point depending on the ratio of the input parameters of the model.

Type of fixed point	The ratio of the input parameters
Stable node	$a + a \cdot c - 1 > 0$ $\frac{\sqrt{D}}{2} \neq 0$
Stable degenerate node	$a + a \cdot c - 1 > 0$ $\frac{\sqrt{D}}{2} = 0$
Saddle	$a + a \cdot c - 1 < 0$
Line of stable fixed points	$a + a \cdot c - 1 = 0$

To carry out numerical experiments and study the behavior of the proposed model, we will construct an imitative model of the process of counteracting bank fraud in terms of system dynamics (Fig. 6).

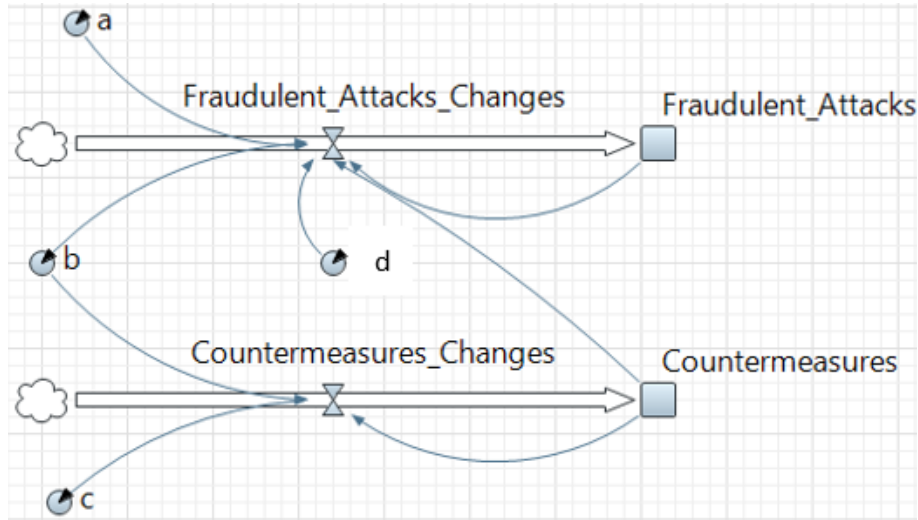

Fig. 6. Stock and flow diagram for the model of the process of counteracting bank fraud.

The structure of constructed model is presented in Table 2.

Table 2. Description of diagram elements.

Name of the diagram	Element of stock and flow diagram
Fraudulent_Attacks	Stock
Countermeasures	Stock
Fraudulent_Attacks_Changes	Flow
Countermeasures_Changes	Flow
<i>a</i>	Parameter
<i>b</i>	Parameter
<i>c</i>	Parameter
<i>d</i>	Parameter

The constructed diagram allowed to carry out simulation experiments, which take into account the various ratios of the input parameters of the proposed model of the process of counteracting bank fraud for obtaining fixed points of the specified types.

The conducted simulation experiments for the saddle case have shown that the number of fraudulent attacks goes to zero over time, and the number of instruments to combat them is approaching some stationary value.

Model experiments for the line of stable fixed points showed a case similar to a saddle.

The construction of timelines and phase portraits of the proposed model for the case of a stable degenerate node caused the necessity of selecting the parameters in such a way that the discriminant of the characteristic equation assumed zero. Such a situation is possible only in the case when the parameter $c=0$. This means that the instruments to counteract fraudulent attacks are successful and there is no their “dead out”. But this

situation is not very attractive from a practical point of view. X and y , as in the case of a stable node, go to some stationary state. But the value of x is quite high. And it will be larger, the more the value of parameter a , the more new fraudulent attacks generate attacks that ended successfully.

Summing up the results of computer simulation, we can conclude that from a practical point of view saddle case and the line of stable fixed points are more acceptable, since in these cases the value of x (the number of fraudulent attacks) goes to zero, regardless of the initial coordinates x and y (coordinates of the initial state of the system). So the value of a parameter must be $a \leq \frac{1}{1+c}$. In terms of its economic content, the parameter c can take values from 0 to 1. Thus, the parameter a should vary from 0.5 to 1. It means that in response to every successful fraud attack, in addition at least one new attack must arise, which is unlikely may be in real life. As a rule, they arise much more.

Accordingly, in practice, the most likely cases are a stable node and a stable degenerate node and should seek to reduce the value. Thus, we should seek to reduce the value of $x = \frac{(1+c)a-1}{(1+c)d}$. From this expression we can see that the most influential are the parameters a and d . Moreover, for a , the connection is straight, and for d is converse.

To summarize, it can be argued that in order to obtain a more favorable situation from a practical point of view, it is necessary to reduce the values of the parameters a and c and increase the parameter d .

5 Conclusions

1. E-banking is an innovative part of e-commerce sphere and could be defined as a remote banking technology that gives the ability to receive banking services via the Internet.
2. The most common type of e-banking fraudulent attack is phishing, which, in general, is a method of acquiring personal financial data of a bank customer with the help of fictitious phone calls, emails and substitution of real websites of banking institutions.
3. In the paper a model of counteracting bank frauds based on of the Lotka-Volterra model with logistic growth and the Holling-Tanner model proposed. It allows to investigate the question of counteracting bank frauds in theoretical form.
4. Simulation experiments, made with the usage of built model, showed that saddle case and the line of stable fixed points are unlikely may be in real life, because it means that in response to every successful fraud attack, in addition at least one new attack must arise. As a rule, they arise much more. In practice, the most likely cases are a stable node and a stable degenerate node.

6 Acknowledgements

The article was executed in the framework of state budget scientific research work No. 0118U003574 "Cyber security in the fight against bank fraud: protection of

financial services consumers and growth of financial and economic security of Ukraine”.

References

1. OECD science, technology, and industry scoreboard: Towards a knowledge-based economy. Organisation for Economic Cooperation and Development. <http://www.oecd.org/> (2019). Accessed 13 Mar 2019
2. Babenko, V., Syniavska, O.: Analysis of the current state of development of electronic commerce market in Ukraine. *Tech. Aud. and Prod. Res.* **5**(4(43)), 40–45 (2018). doi:10.15587/2312-8372.2018.146341
3. Mia, A., Rahman, M., Uddin, M.: E-Banking: Evolution, Status and Prospects. *Cost & Manag.* **1**(35), 36–48 (2007)
4. Lastdrager, E.: Achieving a consensual definition of phishing based on a systematic review of the literature. *Crime Science.* 3:9 (2014). doi:10.1186/s40163-014-0009-y
5. The Statistical Portal. <https://www.statista.com/> (2019). Accessed 13 Mar 2019
6. Jakobsson, M., Myers, S. (ed.) Phishing and countermeasures: understanding the increasing problem of electronic identity theft. John Wiley & Sons, Inc. (2007)
7. J. Shi, S. Saleem.: Phishing: Final Report. <https://www2.cs.arizona.edu/~collberg/Teaching/466-566/2014/Resources/presentations/2012/topic5-final/report.pdf> (2012). Accessed 9 Mar 2019
8. Swanink, R.: Persistent effects of man-in-the-middle attacks. Bachelor Thesis, Radboud University (2016)
9. Damodaram, R.: Study on phishing attacks and antiphishing tools. *IRJET.* **3**(1), 700–705 (2016)
10. Alsayed, A., Bilgrami, A.: E-banking security: Internet hacking, phishing attacks, analysis and prevention of fraudulent activities. *Int. J. Of Emerg. Techn. and Adv. Activ.* 7(1), 109–115 (2017)
11. Delgado, O., Fuster-Sabater, A., Sierra, J.: Analysis of new threats to online banking authentication schemes. In: *Proceedings of the X Spanish Meeting on Cryptology and Information Security (RECSI 2008)*, pp. 337–344 (2008)
12. Hussein, S.: Predator-Prey Modeling. *Undergraduate Journal of Mathematical Modeling: One + Two.* **3**(1), 20 (2010). doi:10.5038/2326-3652.3.1.32
13. Oliinyk, V., Wiebe, I., Syniavska O., Yatsenko, V.: Optimization model of Bass. *JAES,* **8**(62), 2168–2183 (2018)
14. Gupta, R.: Dynamics of a Holling-Tanner Model. *AJER.* **6**(4), 132–140 (2017)
15. Syniavska, O., Dekhtyar, N., Deyneka, O., Zhukova, T., Syniavska, O.: Security of e-banking systems: modelling the process of counteracting e-banking fraud. *SHS Web of Conferences.* **65**, 03004 (2019). doi:10.1051/shsconf/20196503004

Neural Network and Index Forecasting of the Strategies of Development of the Armed Forces of Ukraine Depending on Their Own Economic Opportunities and Encroachments of the Aggressor States

Vasyl Porokhnya

Classical Private University, 70B, Zhukovskoho Str., Zaporizhzhia, 69002, Ukraine
vprhnp76@gmail.com

Oleksandr Ostapenko^[0000-0002-4542-4566]

Taras Shevchenko National University of Kyiv, 60, Volodymyrska Str., Kyiv, 01033, Ukraine
ap080011@gmail.com

Abstract. Ukraine has a relative drawback in the economic defense capabilities, which needs to be addressed by raising the indicators of macroeconomic development, innovation, and economic potential, social health of the population of the state, and the support of the Armed Forces of Ukraine, by the state. The estimation of the defense capability of states like Ukraine, Poland, Russia and Turkey is made on the basis of the developed methodological approach to the overall representation of the health of the economies of the states and their defense capabilities using the method of constructing petal diagrams with the definition of their effective areas, which became indicators of economic status and defense capability. The article analyses the dependence of the development level of the countries' economies and the state of development of the armed forces of these countries in the conditions of resource constraints and existing risks on the basis of macroeconomic data and indicators. This article uses the indicators for the determination of the level of defense capability and the data of petal diagrams and the scenario modeling of the development strategies of the Armed Forces of Ukraine with the aim of constructing the most optimal forecast in this area.

Keywords: Armed Forces of Ukraine, budget, prognostication, strategy, modeling.

1 Introduction

Ukraine as a State has been suffering from specific political, economic and military oppression from various states throughout its entire existence – from ancient times to the present day. Whether it was its geographical location as the center of Europe or ineffective leadership, Ukraine was always forced to defend its legitimate interests,

territorial integrity and independence. Under such conditions, the Armed Forces of Ukraine (the AFU) serve as a key element in the protection of territorial integrity and inviolability of Ukraine, which is entrusted to them by the Constitution of Ukraine.

There is a relative gap in the economic provision of defense capacity in Ukraine. This issue is decided to be solved by the State through the increase of indicators of macroeconomic development of the innovative economic strength, social health of the population and the support of the Armed Forces.

The end of the second decade of the 21st century on the world map was marked by significant military conflicts between states, in which a militarily stronger state usually neglected interests of adjacent states. Firstly, this is related to Russia with respect to such states as Georgia, Moldova, and Ukraine. Processes on the Balkan axis are still fresh wounds from the gunpowder feeling and not quite a healthy environment for economic development. The Syrian conflict amid the movement of the states in this region towards European markets is related to the economic interests of Russia.

Officially this issue affects every state, although those economies that are under the aegis of NATO (Turkey) or Russia (Belarus, Armenia, etc.) find themselves in a more comfortable position in terms of protection. In this context, Ukraine may rely on its own economic strength that is going through the difficult economic situation for the time being. However, there is its own model of finding a way out of the difficult situation and its own driving force able to bring the country into the worldwide level.

State-to-state relations and ties are disturbances in the model of the Armed Forces development strategy based on domestic economic opportunities and invasion from aggressor states that should be formalized by the projected influences on national security.

2 Analysis of Recent Research

The issues of the strategic behavior development of the armed forces have been recently given considerable attention at the world level. This is related primarily to a new spin in the arms race as well as political and economic instability in the world. Therefore, it is important for every state to have the armed forces development strategy based on domestic economic opportunities and invasion from aggressor states. With respect to Ukraine researches and papers of V. Horbulin and A. Kachynskyi deal with the issues of the national security strategic forecasting [1, 3]. The papers of V. Bohdanovych, A. Semchenko also deal with national security enforcement through the formalization of strategic planning in the area of public administration. [2]. In this context the research notes by O. Reznikova and V. Tsiukalo [4, 5] draws attention. Charles J. Hitch outlined the list of the most relevant decisions made with a focus on security and defense [6]. The defense reform algorithm as a way from the form to content [7] was suggested by A. Hrytsenko in 2006.

However, it should be noted that most of the scientific researches in this area do not usually emphasize the study of the economic and military situation of neighboring states and its development, thus resulting in the unreasonable vision being received on

the Armed Forces of Ukraine development strategy as, for example, Ukraine's ability to defend itself.

The question is whether Ukraine is able to reliably defend itself in economic and military terms and which strategy of the AFU development should be chosen based on domestic economic opportunities and invasion from aggressor states. We will try to find the answers in this article.

The purpose of the research is the design of the AFU development strategy based on domestic economic opportunities and invasion from aggressor states.

3 Presentation of the Basic Research

The arms race is the most difficult phase for the economy of any state. This is practically a test of the economic development level for its focus on innovation and competitive ability not only in the defense capacity area but also in the areas shaping the capacity of the economy. The question is, where funding will come from for its own innovative product, or where to borrow money from the available sources in such a way not to worsen the economic health of the state.

Table 1. Data on indicators and indicators of macroeconomic development of states [11-13].

Indicator Title	Ukraine	Poland	Russia	Turkey
GDP, billion USD	109.32	524.89	4.007.83	849.48
Import / Export, USD	62386M/ 53776M	261841M/ 283749M	326.9B/ 411B	214637M/ 189714M
Exports of goods and services in % of GDP	49.3	52.3	26.5	22
Added value in the manufacturing industry in the current rate of price growth, %	3.6	4.3	13.7	3.8
Household consumption expenditure in % of GDP	65.3	58.5	53.09	59.8
Gross capital accumulation in % of GDP	20.4	-7.9	-1.8	29.3
Market capitalization of companies in % of GDP	+15.7	38.4	39.5	26.7
GDP per capita, USD	2583	13823	10.608	10.512
Government's net debt in % of GDP	75.6	51.4	17.4	22.7
Net outflow of foreign direct investment in % of GDP	0.2	0.8	2.4	0.3
Net inflow of foreign direct investment in % of GDP	2.2	1.2	1.8	1.3
Total production of primary energy quadrillion Btu	2.3	2.3	55.9	1.2
Consumption of primary energy quadrillion Btu	3.4	3.9	29.6	5.7
Net energy imports as a share of energy use, %	27.2	28.5	-83.7	75.2

In order to design the AFU development strategy based on domestic economic opportunities let us consider the most common indexes and indicators of the State's economic status directly related to the economy capacity and relatively affecting the level of security and defense capacity. To this end let us use statistical data of the economies of the most powerful four states neighboring Ukraine: Ukraine, Poland, Russia, and Turkey. Summary statistics are given in Table 1.

Figure 1 shows a petal diagram with indicators of macroeconomic development, economic potential, social health of the population and support provided to the AFU by the state: Ukraine, Poland, Russia, Turkey, with the areas as the primary characteristic of the State's possibilities to ensure the defense capacity.

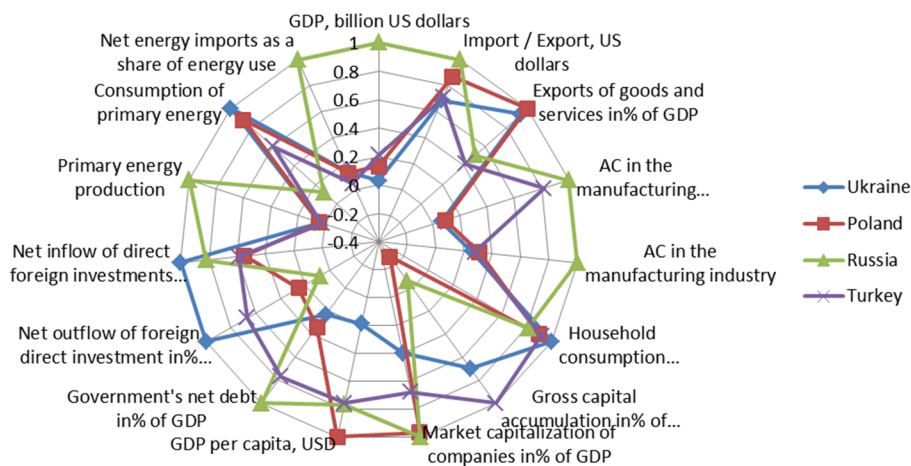

Fig. 1. The petal diagram of macroeconomic development of states: Ukraine, Poland, Russia and Turkey.

In order to get the indicators of economic and military security of the State, it is reasonable to refer to the findings of their estimation by Global Firepower Index, Military Capacity Index and Credit Suisse Institute index and to conduct a comparative analysis of them. The suggested Military Capacity Index built on indicators supplementing other world-famous indexes is focused on covering indicators that characterize the State's ability to restore the defense capacity, Table 2. Data on indicators of economic and military security of the State are given in Table 3.

Thus, according to the Table 3, Ukraine has some challenges with border protection with respect to its neighboring states, as evidenced by the bottom positions of the State by practically three indexes.

The question that has to be answered is which scenario of the defense capacity development should be chosen to improve the security against possible aggression from the potential aggressor states. When it comes to Russia, there is a special relationship here, as since 2014 the northern neighbor has started to invade the territories of Ukraine and in fact is considered to be the greatest threat to the defense capacity of the State. From this perspective we consider several scenarios of strategic axes of defending

Ukraine to satisfy the wish of the State to become an independent country. To this end the fundamental characteristics of the AFU development to be singled out and strategies of the defense capacity of the State to be selected based on them. The most favorable indicators and characteristics able to ensure military changes should include the following: improvement of knowledge, skills and experience in military affairs; increase of defense and security expenditures; increase in number of military personnel; growth of bank credit for the defense industry complex development; budgeting for the defense industry complex development; assistance of NATO states.

Table 2. The economic condition of the State's defense capacity by MCI.

Indicator Title	Ukraine	Poland	Russia	Turkey
GDP, USD billion	109.32	524.89	4007.83	849.48
Resources (dollars) for the defense and security and their percent of GDP	3.648M	10B	631B	18.19B
Arms Import / Export, in USD	18M/ 240M	197B/ 3M	34M/ 6.148B	410B/ 244M
Export of goods and services, in % of GDP	49.3	52.3	26.5	22
The share of high-technology products export, %	7.3	8.5	10.7	2
R&D expenditure as a share of GDP, %	0.6	1	1.1	1
Education expenditures, in % of GDP	5.87	4.91	3.8	4.4
Gross fixed capital formation , in % of GDP	20.4	-7.9	-1.8	29.3
Market capitalization of companies, in % of GDP	+15.7	38.4	39.5	26.7
GDP per capita, USD	2583	13823	10.608	10.512
Global Firepower Index	0.5363	0.4276	0.0841	0.2216
Total strength of military personnel, people	182000/ 1M	184650	3586128	710565
World Competitiveness Index	4.11	4.59	4.64	4.42
Human Development Index, score	0.74	0.86	0.80	0.77
Missile launcher, pieces	625	240	3816	418
Battle tank, pieces	2214	1.065	20300	2446
Armored vehicle, pieces	11868	2608	27400	9031
Artillery arm, pieces	2971	515	6436	1980
Aircraft carrier, pieces	0	0	1	0
Frigate, pieces	1	2	9	16
Corvette, pieces	1	2	78	10
Submarine, pieces	0	4	62	12
Aircraft total number	240	466	3914/818	1056
Helicopter total number	94	227	1451/511	475

Considering the previous indicators that are laid down in the indicators defining the level of defense capacity and clearly characterize the military potential of the State, we

will focus on four feasible strategies of the AFU development: reliance on the Land Forces, Air Forces under the progressive development of other branches; reliance on submarines, aircraft carriers and artillery under the progressive development of other branches; reliance on NATO under the progressive development of other branches; reliance on nuclear weapons under the progressive development of other branches. Table 4 shows the possible proportions of ensuring the development strategies of the Armed Forces that derive from strategic defense development programs for 2010-2025 and a survey of experts who are considering probable economic and political situations of its provision. Their modeling scenarios are not limited to the given data. Their modeling scenarios are not limited to the given data. The preliminary graphic data analysis results in a major trend in the AFU development which primarily depends on the increase of knowledge, skills and experience in military affairs and increase of defense and security expenditures. Although such indicators as the increase in number of military personnel, growth of bank credit for the defense industry complex development, budgeting for the defense industry complex development, assistance of NATO states are essential factors that, to some extent, shape any strategy of the AFU development ensuring the progressive development of other branches.

Table 3. The rating of the states according to the Global Firepower Index, according to the Military Capacity Index and the Credit Suisse Institute Index.

States	Military Capacity Index	Priority by the MCI	Global Firepower Index	Priority by the GFI	Index Credit Suisse,	Priority by the Credit Suisse
Ukraine	0.96	3	0.5363	4	30	4
Poland	0.70	4	0.4276	3	17	3
Russia	1.93	1	0.0841	1	2	1
Turkey	1.17	2	0.2216	2	10	2

Table 4. AFU development strategies

Strategies	Improvement of knowledge, skills and experience	Defense and security expenditures	Increase in number of military personnel	Growth of bank credit for the defense industry complex development	Budgeting for the defense industry complex development	Assistance of NATO states
Reliance on the Land Forces, Air Forces, %	50.0	70.0	30.0	40.0	75.0	22.50
Reliance on submarines, aircraft carriers and artillery, %	90.0	80.0	40.0	50.0	70.0	45.00
Reliance on NATO, %	55.0	40.0	15.0	30.0	50.0	38.50
Reliance on nuclear weapons, %	65.0	85.0	20.0	50.0	70.0	8.50

Considering that Table 3 presents the minimum values of the development indicators of the Armed Forces of Ukraine, the best development strategy can be chosen based on the diagram of petals by the criterion indicating that dependence on submarines, aircraft carriers and artillery in the conditions of progressive development of other industries is optimal, Table 5.

Table 5. Criterion for the selection of the best AFU development scenario.

AFU development strategies	Selection of the optimal scenario
Reliance on submarines, aircraft carriers and artillery	1.002
Reliance on the Land Forces, Air Forces	1.275
Reliance on NATO	1.071
Reliance on nuclear weapons	0.796

Now let us make a neural network based on the presentation of the multi-layered perceptron structure to compare the results of the AFU development strategies by the two methods, Figure 2-3. First of all, let us form a matrix out of the known input indexes, then normalize and establish boundary parameters for the evaluation of strategies [10].

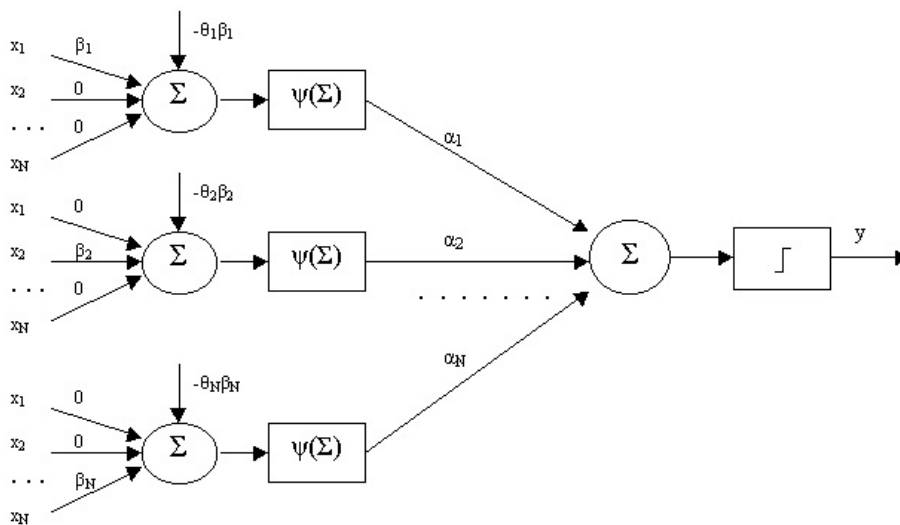

Fig. 2. The overall structure of the neural network [14].

In Fig. 2 shows the notation: $x = \{x_1, x_2, \dots, x_S\}$ – parameters for the evaluation of strategies; the activation function $\psi(\Sigma)$ of the i -layer neuron; w_i – synaptic weights.

The mentioned indicators and their variations reflect the selection of possible AFU strategies on a reasonable basis:

1. Strategy – coefficients options are lower by the midpoint of the range – Reliance on NATO;
2. Strategy – coefficients options are mixed exceeding the midpoint of the range – Reliance on submarines, aircraft carriers, and artillery;
3. Strategy – coefficients options approach the maximum point of the range – Reliance on Missile Forces, Air Defense.

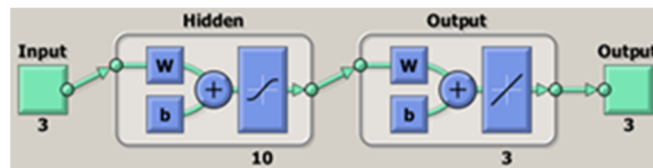

Fig. 3. A neural network structure.

As target indicators, the boundary characteristics of these three indicators for each strategy are selected separately. The run of the neural network is three times, where the convolution for each strategy serves as a good indicator. A comparison of performance indicators makes it possible to assess the prioritization of strategies.

The findings of the AFU strategic development should be obtained after the network training Regression, Figure 4.

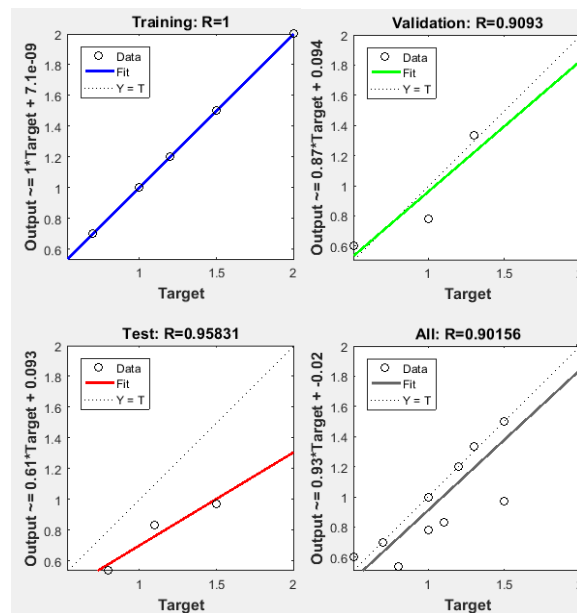

Fig. 4. Outcomes of the neural network training and simulation of the forecasting of the AFU development strategy selection.

The indicators for the AFU that have the following values have been taken as current calculations, namely, Table 6.

Table 6. Strategies for the development of the Armed Forces of Ukraine

Index	Strategy 1	Strategy 2	Strategy 3
MCI	1	1.56	1.63
GFI	1.39	1.39	1.58
ICS	0.6	1.05	0.75
OUT	1.0	1.33	1.32

In the result of the study, the following strategy for the development of the Armed Forces of Ukraine has been received – Reliance on submarines, aircraft carriers, and artillery.

4 Conclusions

The outcomes of the defense capacity indexes' evaluation of Ukraine, Poland, Russia, and Turkey indicate some deviations of the states' ratings according to the Military Capacity Index (MCI) as compared to the Global Firepower Index (GFI) and the Credit Suisse (CS) Institute Index with regard to Ukraine and Poland. According to the Global Firepower Index (GFI) Ukraine is inferior to Poland, and according to the Military Capacity Index (MCI) – on the contrary. This suggests that both states have practically the same level of defense capacity except that Poland is a NATO member state. Regarding the economic status of the defense capacity of Turkey and Russia, Russia has the lead and ranks world second after the USA. Although they also have significant economic problems that, in the long term, will provide Ukraine the possibility with proper planning of the defense capacity and availability of considerable intellectual capital, to reach their level and to ensure the inviolability of the state's borders from possible invasion.

Scenario modeling to select the best AFU development scenario allows you to formulate the best development strategy indicating that reliance on submarines, aircraft carriers, and artillery in the context of the progressive development of other industries is possible but very costly. Therefore, the options of betting on missile troops and Air Defense are preferable, which in terms of indicators has a slight discrepancy.

The outcomes indicate that both methods of the search for the AFU development strategies complement each other and provide an overall picture of the possible directions to achieve a responsible goal related to the defense capacity of the State.

References

1. Horbulin, V.P.: Strategic planning: solution to national security challenges. NISS, Kyiv (2010)
2. Bohdanovych, V.Yu.: Method of strategic planning formalization in the area of public administration to ensure national security. Str. Pan. 3, 42–53 (2006)

3. Kachynskiy, A.B.: Security, threats and risk: scientific concepts and mathematical methods. Kyiv (2003)
4. Reznikova, O.O., Tsiukalo, V.Yu.: The development of the strategic planning and forecasting system in the area of national security of Ukraine. <http://www.niss.gov.ua/articles/1847> (2018). Accessed 05 Feb 2019
5. Reznikova, O.O.: Ensuring the resistance of the State and society to the terrorist threat in Ukraine and in the world. *Str. Pr.* 3(44), 23–24 (2017)
6. Mozharovskiy, V.M., Hodz , S.V.: Methodical Aspects of the Substantiation of the Manpower of the Armed Forces of the State from the Standpoint of the Prevented Damage Theory. *Cyb. and Sys. An.* 54(1), 139–151 (2018)
7. Mozharovskiy, V.M., Hodz , S.V.: Mathematical Model of the Substantiation of the Optimal Combat Staff of the Armed Forces of the State from the Standpoint of the Theory of Prevented Damage and with Regard to Economic Review. *Cyb. and Sys. An.* 54(5), 815–823 (2018).
8. Charles J.: *Hitch, Decision Making for Defense*. Science, New York (2004)
9. Grytsenko, A.: Civil-military relations in Ukraine: On the way from Form to substance, NATO Fellowship Programme. <http://www.nato.int/acad/fellow/98-00/grytsenko.pdf> (2000). Accessed 15 Jan 2019
10. Porokhnya V.M.: *Expert systems in economy*. Zaporizhzhia (1997)
11. World Data Atlas. <https://knoema.com/atlas> (2018) Accessed 29 Jan 2019
12. Globalfirepower. <https://www.globalfirepower.com/countries-listing-europe.asp> (2018). Accessed 20 Jan 2019
13. CreditSuisse. <https://www.credit-suisse.com/corporate/en/research/research-institute/publications.html> (2018). Accessed 28 Jan 2019
14. Subbotin, S.O., Fedorchenko, E.M.: Methodical instructions for the implementation of laboratory works on discipline “Neural Network Design” for students of the training direction 6.050101 “Computer Science” of all forms of study. Zaporizhzhya (2013).
15. Porokhnya, V., Ostapenko, O.: Neural network and index forecasting of the strategies of development of the armed forces of Ukraine depending on their own economic opportunities and encroachments of the states of aggressors. *SHS Web of Conferences.* 65, 04004 (2019). doi:10.1051/shsconf/20196504004

Formation of the Context of the Company's Economic Activity in the Strategic Positioning Process at Emergent Environment

Mykhaylo Voynarenko, Kathrin Dumanska and Nataliya Ponomaryova

Khmelnysky National University, 11, Instytutska Str., Khmelnytsky, 29000, Ukraine
voynarenko@ukr.net, Dukatos2020@bigmir.net, n-snake@ukr.net

Abstract. Analytical studies of theoretical and methodological aspects of company's strategic positioning influenced by unpredictable factors of changeable environment are examined in the article. Justification of effective choice of strategic position is provided by the concept of formation of company's economic activity context in emergent environment proposed by the authors. Problems of strengthening of company's strategic position in conditions of changeable economic environment with undefined factors can be solved by means of the developed model of company's economic activity context on the basis of methods of mathematical modeling. One of the advantages of the model implementation can be the usage of methodology of company's strategic positioning in economic environment. The model elaborated by the authors implies a set of analytical-calculative aspects of testing and further implementation in strategic management practice. The given article proposes the first conceptual methodological stage of model of company's economic activity context implementation. The obtained results of further adoption can be applied as element of strategic management of vertically integrated companies in conditions of emergent environmental challenges.

Keywords: economic activity context, strategic positioning, mathematical modeling, emergent environment.

1 Introduction

The current state and contemporary conditions of domestic economy restructuring demand from companies quite new economic approaches. Integration steps of Ukraine into the European Economic Community create new perspectives on the recruitment processes, organization of production, or availability of new ideas and innovative projects. The concept of business development efficiency is also changing and significant role in this process is played by successfully selected strategic position of the company. New approaches towards strategic position selection and evaluation of its effectiveness will increase the flexibility of the company's response to changes in the economic environment, which in their turn will strengthen competitiveness of the company in the market and will allow more effective adaptation to the new conditions

of development, updated quality standards and methods of product promotion. It is important to remember that the period of renovation of the economy stimulates companies to maintain their own position in the domestic market, on the one hand, and successful entry into foreign markets, on the other. In order to solve such problems it is necessary to apply conceptually new approaches that can unite both differences and similarities that exist between identification and choosing strategic position as processes of company's management. Such approach, in accordance with author's idea, can be modeling of company's economic activity context considering its emergent aspects.

Strategic positioning problems were proposed and discussed by different prominent economists and their theoretical view points and practical explorations are of valuable importance for further researches and supporters.

The research of the effectiveness of company's strategic positioning was initiated by I. Ansoff in his work "New corporate strategy" [1]. Being one of the representatives and supporters of systematization approach in company's strategic development concept and founder of the "school of planning", Ansoff, applied his systematic approach of corporate strategy shaping and company's strategic positioning, which in the 60s has become an innovation in the processes of corporate management [2].

One of the founders of the "school of design", professor of the Harvard Business School, K. Andrew, in his work "The Concept of Corporate Strategy" (1965) provided quite innovative interpretation of the assessment of company's strategic positioning, which in his view should assess "... such kind of business, within which the company can compete due to such stages of concentration of its resources that allow company to transform its abilities into competitive advantages" [3].

J. March, the founder and ideological leader of the "school of learning", and prominent representative of the behaviorists' approach, in his work "Behaviorists' Theory of the Firm" proposes to assess the corporate strategy as "... an internal mechanism that determines the company's behavior in the market during the period of competition concerning necessary resources ..." [4], which transforms the company's strategy from managerial to adaptive leverage of strategic positioning.

Significant contribution to the development of competitive direction of the behavioural approach and the "school of positioning" was made by Harvard University Professor M. Porter in the 70's–80's of the 20th century through the development and implementation into the activity of more than 100 American companies the latest aspects of strategic modeling by such as general strategic model (it is often mentioned by economists as "M. Porter's strategic model"), the "chain of values" method, the methodology of company's strategic positioning [5]. From the point of view of progress, in changing of approaches to assessing the company's strategic positioning, we can observe a quite clear change in Professor Porter's views in his earlier and modern works. And if the "early" Porter has fully emphasized the leading role of the corporate strategy in the process of effective company's positioning in competitive environment, Porter of the later period defends rather an opposite position, which destroys the standard methodological approaches to the assessment of adaptive processes of the company. In his works of the 80's–90's, M. Porter has paid maximum attention to the individualization of the corporate strategy of each individual company.

He affirming that strategy is not only a leverage of successful company's positioning, but the basis of its competitive advantages and victories: "The strategy is aimed at searching for development of an individual and unique way to compete not only because it is the most versatile way for competition, but also because it allows a company to build the activity of its price (production) chain individually and uniquely. Strategy is the development of a special type of value (commodity), but not an attempt to make the same kind of value (commodity) but only better one" [6]. M. Porter, as the initiator of the creation of economic clusters and the founder of the nonprofit organization of the United States, "The Initiative for a Competitive Inner City" (founded in 1994 by Harvard Business School Professor Michael Porter) proved that the competitiveness and adaptability of the company is determined by the competitiveness and adaptability of its economic environment, and in its turn, depends on the basic conditions and competition within the cluster (<http://icic.org/member/professor-michael-e-porter>).

E. Utkin, one of the supporters of behavioural trend, became a bright representative in the field of strategic and crisis management companies in the 90's-2000's [7]. The basis of proposed methodology in the field of evaluation of company's strategic positioning is the application of the basic component of corporate management – the motivation of each individual employee of the team in different ways according to psychological peculiarities.

At the beginning of the XXI century many foreign of domestic economists specializing in the study of multi-level issues of company's strategic positioning supported and followed the world economic opinion regarding the assessment of the effectiveness of company's strategic adaptation and positioning in a wide range of their activities. The authors of the scientific works research problems of positioning and adaptation of industrial companies, trade networks, advertising agencies and the adequacy of their strategies in a changing environment with flexible competition. In this context, A. Gradov, as one of the supporters of the competitive approach in the study of strategic activity of business entities, in his work "Strategy firm effectiveness" [8] offers a specific generalized approach towards assessing the strategy's effectiveness and positioning of the firm based on the integrated business theory expressed by the scheme of assessing the effectiveness of the company's positioning and development.

Contemporary researchers in the field of strategic aspects of the company's economic activity context formation pay special attention on the consideration of the processes of choosing strategic position, based on behavioural and emergent approaches. For example, H. Greve and G. Gavetti [9], in the framework of the behavioural approach, propose modern methods for evaluating the effectiveness of company's strategy from the point of view of competitiveness and psychological assessment of activities of the customer. P. Beamish and N. Lupton [10] in their critical analysis of Andrews' research focus on the transition of modern companies from the internal concentration of competitive resources to the exit beyond the geographical boundaries of countries and reorientation to global international level of competitive opportunities.

M. Augier [11] in his turn, proposes a number of modern methods for evaluation the process of company's adaptability in the market and the basis of such methods can be considered as the classical behavioural approach.

The concept of an emergent strategy and an emergent strategic approach to management in accordance with the classification of H. Mintzberg [12] has appeared in the "school of learning", where the principle of emergent strategy is based on the adoption of flexible intellectual decisions of a company manager in crisis situations.

Authors' approach towards strategic positioning can be revealed in the process of business capitalization modeling and formation of company's alternative strategic position in economic environment [13] and estimation of positioning effectiveness of energetic companies in conditions of European integration [14]. Researching in the field of transformation of social-economic system in conditions of global integration was accomplished from the point of view of conceptual basis of economic emergent processes [15].

2 Research Methodology

The concept of emergency reflects peculiarities of company's activities in conditions of unpredicted appearance of environmental challenges that are characteristic for unstable politico-economical, social, legislative and other factors. Unpredicted environmental changes, in their turn, can lead to company's emergent reactions in the form of concentration of principally new strategic resources and possibilities in activity in conditions of unstable environment. Methodological apparatus of applied mathematical methods can provide wide possibilities for reflection and analysis of key aspects of company's emergent reactions in economic environment.

On the basic of mathematical modeling methodology the proposed model of company's economic activity context was formed and presented by means of indirectly proportional semi-logarithmic dependence of duration of the alternative strategy formation (productive feature of the environment) from the conjuncture of its economic environment (factor of nature of the environment) and was reflected by vectors' system.

3 Results

3.1 Concept of Formation of Company's Economic Activity Context in Emergent Environment

Management of modern industrial companies provides a clear modeling of their economic activity context. The construction of a clearly structured and, at the same time, ramified model of situational analysis of the environment of an economic entity provides an opportunity for its effective strategic positioning and adaptation to existing economic, political, social, natural and other conditions of existence. However, the rate of change in external as well as internal factors of influence has been so high in recent years that companies do not have any time or opportunity to react quickly and construct adequate development models even for the next six months. Possibility of preventing

significant losses of the company in a similar situation gives a successful choice of strategic position, which is preceded by a thorough analysis of the internal, external, direct and market environment, and that can be resulted in forecasting the use of the necessary resources, costs and profits. In bits turn, the choice of effective strategic position of the company depends on the factors of its environment. That is why the authors have selected an emergent research direction, which provides “operative mobilization of fundamentally new qualities” [16] of a changing environment and reveals the peculiarities of its influence on the company’s activities.

According to the authors’ explorations, it is advisable to consider the emergence concept factors of company’s environment in the direction of emergent strategic management that ensures spontaneous and flexible adaptation to the conditions of external environment and promotes a timely response to processes of bifurcation, nonlinear changes in the trends of external indicators. One of the examples of manifestation of the emergence strategic management concept is the company’s micro strategy [17], focused on short-term implementation with the achievement of short-term goals that can ensure the flexibility and speed of the company’s response to the influence of environmental factors. On the one hand, emergence concept characterizes peculiarities of company’s activities in conditions of contemporary Ukrainian economy with its emergent challengers that can appear on the side of social policy, legislation, pricing, tariff formation and other environmental factors. At the same time, on the other hand, emergency creates principally new reactions on environmental “irritants” that can stimulate company in searching new possibilities of surviving and allow its further development. Thus emergence concept simultaneously discloses the essence of company’s economic activity context and provides possibilities of effective reactions on various environmental changes.

Taking into consideration authors viewpoint it can be stressed that well-formed economic activity context provides the company with the opportunity to effectively predict the duration of strategic adaptation in a changing economic environment and tendencies for further development within a certain time lag according to corporate strategy. Based on the information on the state of factor and performance indicators of the economic environment in the form of economic indicators of the context of economic activity, the company is able to forecast its competitive position in the market, which, in turn, allows us to form a strategic direction of development and to determine a convenient strategic position.

Effective strategic positioning of company in the market provides high level of its competitiveness, especially in conditions of dynamic economic environment [18]. Successful strategic position, fresh commercial ideas and various market advantages allow companies maintain favorable conditions for effective business activities and they can easily dictate their rules to partners and competitors. That is why modern companies consider effective strategic positioning to be one of the major aspects of corporative strategy formation. One of the most important factors of a company’s strategic position selection is the successful formation of the context of its economic activity. The “context of economic activity” is explained by the authors as “the space of parameters of the economic environment in which it is possible to trace and predict the dynamics of changes in conditions of the company, the dynamics of changes in

factor and indicators performance of the economic environment, presented in the form of economic indicators, and the duration of the process of strategic adaptation in given conditions” [19].

The concept of formation of company’s economic activity context, according to the authors, is based on a number of such processes as:

- formulating company goals;
- studying economic environment and level of factors of its emergence;
- determination of critical elements of a market environment and internal environment that can affect the company’s ability to achieve its goals;
- forecasting of company’s interaction with economic environment in future.

The question of company’s influence on the economic activity context and its contextual dependence is controversial, as the impact of one or another economic force depends on situational changes in the country’s economy that can increase or decrease the company’s value in domestic or foreign markets. However, the predicted formation of the context of its economic activity provides the company with the ability to succeed in such economic situations that are not yet come, but successfully may be fulfilled. Based on the experience of well-known world companies [20], authors propose to form the context of the economic activity of the investigated companies on the basis of two stages. The first stage, the assessment of the economic environment influence on the company’s activity, is carried out by using such methods as the method of determining the degree of influence of factors of the economic environment on the company’s activities, the SWOT-method, the method of forecasting of strategic changes in the components of the company’s economic environment, and the method of identifying the potential of internal capabilities of enterprises and companies. The second stage, an assessment of the strategic adaptation of the company, is carried out by using the method of determining the strategic adaptation of the company. Thus, the results of the process of assessing the impact of the economic environment on the company’s activities and the process of assessing its strategic adaptation can form the context of the company’s economic activity within its framework.

The ultimate goal of company’s economic environment forming is to determine its effective strategic position in conditions emergent influence of external factors, for the visual representation of the situation, thus the authors have chosen precisely such like mathematical models that take into account the plurality and uncertainty of the environment. As a result of the combination of semi-logarithmic dependence on the theory of sets, the authors formed the model of company’s economic activity context that became the basis for choosing a strategic position under the conditions of the emergent environment.

The proposed model takes the first stage of elaboration and has a theoretical-methodological character. In authors idea the model of company’s economic activity context implementation implies the following stages:

1. Conceptual justification of model’s necessity in conditions of company’s emergent economic environment.

2. Analysis of current indicators of existing corporative strategies of vertically integrated Ukrainian industrial companies.
3. Comparative analysis of current and predictable indicators company's economic environment conjuncture and justification of its percentage proportion influenced by emergent factors.
4. Elaboration of alternative companies' corporative strategies and effective strategic position choice considering influence of company's economic environment factors.

Quite often in the process of economic researches scientists may come across problems of shortage of results visibility and consequently the level of readers' perception of proposed material can be greatly decreased. That is why authors propose one of the methods of visibility with the help of which the model of company's economic activity context can be depicted mathematically in the form of semi-logarithmic dependence of the duration of company's strategic adaptation of the economic environment conjunction. In our opinion, semi-logarithmic dependence gives possibility of a generalized description of the company's dependence on the environment in which it operates and attempts to adapt adequately, developing the appropriate options for a development strategy. This dependence reveals characteristic changes in the company's strategic position during the time with the instability of economic indicators of its environment [21]. Within the company's economic activity context it is possible to trace and predict dynamics of changes in the results of its activities in accordance with the economic environment conjuncture, the duration of strategic adaptation and other factor and performance characteristics of the environment, presented in the form of economic indicators that have direct and indirect influence on company's activities. Under the definition of "economic environment conjuncture" [22] authors mean "the total influence of a number of indicators that are characteristic of a qualitative description of changes impact in the economic environment on the duration of the company's strategic positioning". In its turn, under the duration of the company's strategic positioning, we can understand the time that is necessary for the development of alternative strategy options.

3.2 Modeling of company's economic activity context

Authors propose to establish the suitable model of company's economic activity context (Fig. 1.) in following form, where main parameters of the model are Y (as a duration of the alternative strategy formation) and X (as an economic environment conjuncture).

The model of company's economic activity context, in accordance with authors' idea, can be expressed by indirectly proportional semi-logarithmic dependence of duration of the alternative strategy formation (productive feature of the environment) from the conjuncture of its economic environment (factor of nature of the environment). For example, according to this model, the change in the economic environment conjuncture by 10% compared with its current value will change the duration of the alternative strategy formation by 15%, and the change in the corresponding indicator

by 10% in condition of changed economic environment determines changes of the corresponding indicator by 5%.

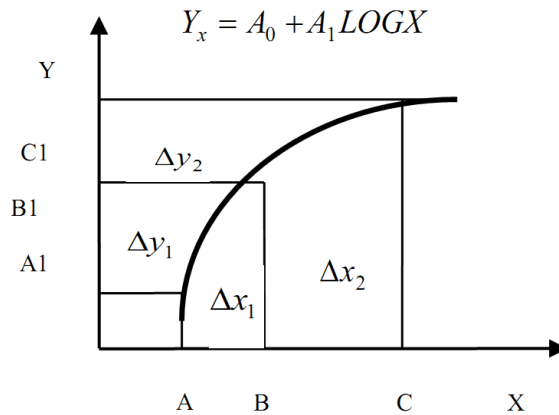

Fig. 1. The model of company's economic activity context.

So, it is important to underline the necessity of depicting economic environment of the company and its components within company's economic activity context as vectors system in accordance with the set theory is quite obvious. And it is the set theory that reflects multiple opportunities of changeability of unpredictable situations.

It the researching process such parameters of vectors system of companies' economic environment, as: IE – internal environment, DE – direct environment, EE – external environment, ME – market environment, EcE – economic environment, where proposed by the authors.

The obtained vectors system of company's economic environment is represented below:

$$\vec{IE} = \{a_1, a_2, \dots, a_i\},$$

where i – number of parameters of the internal environment;

$$\vec{DI} = \{b_1, b_2, \dots, b_d\},$$

where d – number of parameters of the direct environment;

$$\vec{EE} = \{c_1, c_2, \dots, c_e\},$$

where e – number of parameters of the external environment;

$$\vec{ME} = \{d_1, d_2, \dots, d_m\},$$

where m – number of parameters of the market environment;

$$\bar{E}cE = \{f_1, f_2, \dots, f_{e_c}\},$$

where e_c – number of parameters of the economic environment.

In frame of mathematic modeling the set theory suggests not only vector reflection data but matrix as well. With the help of matrix it'll be possible to calculate current and predictive range of situational data. That is why, the authors have elaborated the matrix for determining the influence of current and emergent factors on company's activity. Consequently, we decided to represent the company's economic environment according to set theory by the formula 1, as:

$$\left. \begin{array}{l} \forall d \in DE \rightarrow m \in \bar{M}E \\ \forall e \in EE \rightarrow m \in \bar{M}E \\ ME = EE \cap DE \\ \forall i \in IE \rightarrow e_c \in \bar{E}_cE \\ \forall d \in DE \rightarrow e_c \in \bar{E}_cE \\ \forall e \in EE \rightarrow e_c \in \bar{E}_cE \\ \forall m \in ME \rightarrow e_c \in \bar{E}_cE \end{array} \right\} \Rightarrow \bar{E}_cE = IE \cap ME \quad (1)$$

On the basis of set theory we propose to depict economic environment with the help of Eulerian circles as illustration of our conceptual approach that are shown in Fig. 2.

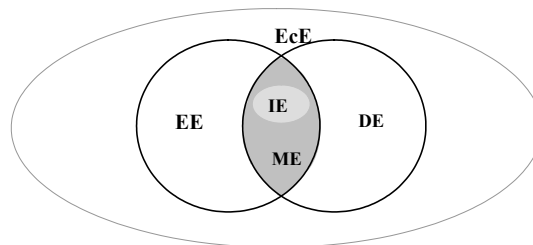

Fig. 2. The scheme of company's positioning in economic environment context based set theory.

Taking into consideration authors' opinion, the proposed model of company's economic activity context, based on mathematic models, can be an easy and suitable way for predicting future changes of company's economic environment.

3.3 Company's Positioning in the Economic Environment Context

The essence of the process of choosing company's strategic position is to find and specify the strategic direction of development in frame of which managers can develop a corporate strategy based on the data obtained on the state of the economic

environment. Such data include: existing and prospective potential of company, the level of strategic adaptation, general level of strategic business units' (SBU) [23] prospects as well as competitive status and competitive position of company in the market. In particular, for industrial enterprises, it is proposed to highlight progressive and regressive directions of strategy development. Progressive directions cover diversification, integration, and concentration processes, while regressive trends cover processes of reduction, elimination. The progressive/regressive directions of the development of company's industrial strategy is proposed to determine boundaries of the model of company's economic activity context (according to its competitive position) depending on state of factors of economic activity context, in particular, the economic environment conditions for the period of strategy formation, the level of strategic potential of success and competitive status.

Effective choice of company's strategic position or its positioning in the market space is the key to company's success in the market. The well-grounded strategic position allows an entity to occupy an appropriate market position or market niche, which provides possibility of successful adaptation within the direct environment, market environment and economic environment as a whole.

The process of company's positioning in economic environment context, in our opinion, can be represented in the form of three main processes, such as:

- formation and evaluation of effectiveness of strategic business units' (SBU) activity;
- determination of the strategic success potential of company;
- estimation of the competitive status.

Company's positioning in the economic environment context involves the determination of its location relatively to the competitive position of its competitors. Such world known consulting companies, as the Boston Advisory Group (1968-1972), GE/McKinsey & Co (1971-1973), together with General Electric, Arthur D. Little's Company (1979-1980), as well as the British- Holland Chemical Company Shell (1975) have already developed series of classic models of strategic analysis and planning of corporate activities, these models are based on comprehensive analysis of the economic environment, creation of future forecasting development models and collaboration of a number of alternative company's strategies taking into account environmental emergency. The economic value and usefulness of applying classical models in the process of selecting and shaping strategic position of the company lie in the methodological and mathematical apparatus especially reacted for such like models, which provide analysis and processing of strategic information and adoption of appropriate managerial decisions. Strategic information encompasses processes of the company's operation in present and in future in the directions of all possible aspects of the activities, taking into consideration peculiarities of adaptation in the economic activity context. The strategic information collected is used by the company's management to develop a corporate strategy.

In particular, as the Ukrainian industrial companies are concerned, the authors propose strategic positioning based on the classical model of strategic analysis and planning of Shell Directional Policy Matrix (Shell/DPM). The Shell/DPM model, in our opinion, is quite optimal for determining the company's competitive position in the

context of the economic environment due to its orientation towards application in vertically integrated companies. Vertical integration is widespread in domestic companies, especially in the branch of mechanical engineering, because all activities (business) are based on the leading technological line for the production of the dominant type (group) of products, which is aimed at only one segment of the market. In such cases when the company also produces goods for different segments of the market, its production is carried out by units of one company, i.e., one company provides operation of several strategic business units.

In conclusion, we can note that in the process of research of proposed topic certain requirements that should be observed in case of choosing and forming a strategic position of the company were formulated by the authors. These requirements encompass the following spheres of managerial activity:

- formation of a strategic direction on the basis of analysis of the determined goals;
- establishment of harmonious connection between the chosen strategic direction and the state of economic environment factors;
- ensuring a high level of flexibility and adaptability of selected strategic direction in accordance with the main parameters of the environmental assessment (parameters of the economic environment modeling and modeling of the company's competitive position).

Contemporary situation and current conditions of the Ukrainian economy are rather specific and complicated, on the one hand, the development of domestic companies is one of the major and primary tasks of economic development, and on the other hand, companies are faced with massive pressure of fleeting changes in the legislative framework and socio-political conditions that destabilize their work and deprive them of opportunities for successful development. But such like economic situation gives companies an invaluable experience of practical learning to survive and can force them to mobilize their opportunities for the development in the context of rapid changes. Summarizing the diversity of theoretical and practical view points on the topic, we can conclude that in this particular situation, the proposed model of the company's economic activity context provides business with ability to assess the impact of an incalculable number of the economic environment factors and helps to obtain the most reliable evaluation of the adaptive capabilities of the company in existed economic conditions.

4 Conclusions

The mechanism of strategic management of the company provides such conditions of its functioning that ensure stability of the development and the ability to respond flexibly to the challenges of the external environment. That is why the variability of the company's development should be considered at the level of strategic management, including the hierarchy of corporate strategy objectives such as ability for adaptation to predict and reflect unpredictable changes in the economic environment. The proposed model of company's economic activity context gives an opportunity to fulfill an

effective choice of company's strategic position in conditions of emergent environment factors and to predict favorable conditions for development and functioning in the market. It is important to recognize that this model makes it possible to know where the company has been, where it is now and where it is going to. This is especially valuable because it provides the company with possibility of more flexible strategic management as well as stable enduring resistance to adverse impact of the environment.

The problem of effective development of diversified companies is of great importance, as the positive general economic effect in a particular industry and economy as a whole can be achieved only through the successful functioning of each separate structural unit in the integrated international economic system. In its turn, the high level of instability of the company's economic environment as an economic structural unit of dramatically increases the importance of strategic positioning, because such a process allows to coordinate company's activities in different functional areas, mobilize resources and if necessary can direct company to the solution of internal and external problems. As it can be traced, the effective strategic positioning ensures the formation of adoptive and flexible context of company's economic activity in emergent environment conditions.

References

1. Ansoff, H.I.: *The New Corporate Strategy*. Wiley, New York (1988)
2. Ansoff, H.I.: *Business Strategy*. Penguin Books, Harmondsworth (1969)
3. Andrews, K.R.: *The Concept of Corporate Strategy*. Dow Jones-Irwin Inc, Homewood, Illinois (1971)
4. Cyert, R.K., March, J.G.: *A Behavioural Theory of the Firm*. Macmillian, London (1979)
5. Porter, M.E.: *Competitive Advantage: Creating and Sustaining Superior Performance*. Free Press, New York (1985)
6. Hodgetts, R.M.: A Conversation with Michael E. Porter: a 'significant extension' toward operational improvement and positioning. *Organizational Dynamic*. **7**, 24 (1999)
7. Utkin, E.A., Morozova, G.I., Morozova, N.I.: *Innovatsionnyy menedzhment*. Akalis, Moskva (2002)
8. Gradov, A.P.: *Effektivnost strategii firmy*. Spets. Lit, Sankt-Peterburg (2007)
9. Gavetti, G., Greve, H.R., Levinthal, D.A., Ocasio, W.: The behavioural theory of the firm: assesment and prospects. *The Academy of Management Annals*. **6**(1), 1–40 (2012). doi:10.1080/19416520.2012.656841
10. Beamish, P.W., Lupton N.C.: Cooperative strategies in international business and management: reflections on the past 50 years and future directions. *Journal of World Business*. **51**(1), 163–175 (2016). doi:10.1016/j.jwb.2015.08.013
11. Augier, M.: Behavioral theory of the firm: hopes for the past; lessons from the future. *Management*. **16**(5), 636–652 (2013). doi:10.3917/mana.165.0636
12. Mintzberg, H.: The strategy concept II: another look at why organizations need strategies. *California Management Review*. **30**(1), 25–32 (1987)
13. Asaul, A.N., Voynarenko, M.P., Skorobogata, L.V.: Transformation of business capitalization model within the knowledge economy. *Actual Problems of Economics*. **11**(161), 8–16 (2014)
14. Voynarenko, M.P., Mykolyuk, O.A.: Strategic energy security outlook formation of Ukraine under European integration process. *Scientific Bulletin Polissia*. **3**(11), 29–37 (2017)

15. Voinarenko, M.P., Honchar, O.I.: Transformatsiia sotsialno-ekonomichnykh system za umov intehratsiinykh peretvoren. *Zhurnal Yevropeiskoi ekonomiky*. 17(2), 225–243 (2018)
16. Muratov, A.S., Povarich, P.L.: Sinergizm i emerzhentnost: genezis ikh garmonizatsii v ekonomike i upravlenii. *Vestnik KemGU*, 1(49), 271–275 (2012)
17. Khalkvat, K.: Kontsepsiya strategicheskogo upravleniya rozvitiyem predpriyatiy. *Menedzher*. 2(68), 155–162 (2014)
18. Ansoff, H.I., Kipley, D., Lewis, A.O., Helm-Stevens, R., Ansoff, R.: *Implanting Strategic Management*. Wiley, New York (2018)
19. Dumanska, K.S.: *Mekhanizm rozrobky stratehii promyslovoho pidpriemstva na osnovi systemnoho pidkhodu*. FOP Melnyk, Khmelnytski (2015)
20. Voropaev, V., Gelrud, Y.D., Klimenko, O.: Who manages what? Project management for different stakeholders. *Procedia Social and Behavioral Sciences*. **226**, 478–485 (2016) doi:10.1016/j.sbspro.2016.06.214
21. Khanfar, A.A., Mavi, R.K., Jie, F.: Prioritizing critical failure factors of IT projects with fuzzy analytic hierarchy process. In: *Proceeding of the International Conference on Mathematics, Engineering and Industrial Applications*. AIP Conference Proceedings. **2013**, 1, 020058 (2018). doi:10.1063/1.5054257
22. Ponomaryova, N.A.: Premises for creation and development of innovation cluster structures under conditions of institutional economic development. In: Musial, J. (ed.). *Actual Problems of Modern Science*, vol. 1, pp. 110-119. University of Science and Technology, Bydgoszcz (2017)
23. Ansoff, H.I.: *Strategic Management*. Wiley, New York (2007)
24. Voynarenko, M., Dumanska, K., Ponomaryova, N.: Formation of company's economic activity context in the strategic positioning process in emergent environment conditions. *SHS Web of Conferences*. **65**, 04005 (2019). doi:10.1051/shsconf/20196504005

Assessment of the Dynamics of Bifurcation Transformations in the Economy

Tetyana Vasilyeva, Olha Kuzmenko^[0000-0001-8575-5725], Victoria Bozhenko
and Olena Kolotilina

Sumy State University, 2, Rymkoho-Korsakova Str., Sumy, 40000, Ukraine
tvasilyeva@fem.sumdu.edu.ua, {okuzmenko84, vroienko}@gmail.com,
o.kolotilina@uabs.sumdu.edu.ua

Abstract. The current global economy faces pivotal changes in the system of its organization, which are essentially transforming relations between economic agents, government institutions, and the population of a particular country. Therefore, the study aims to quantitatively assess the level of transformations in the social, economic and political development of some European countries (Ukraine, France, Italy) using bifurcation theory for the period of 2000-2017. The proposed scientific and methodological approach to assessing the level of transformations in the social, economic and political development of a particular country involves the step-wise implementation: 1) the formation of an information base for the study, which involves collecting and testing statistical data for anomaly detection using the Irwin method, and selecting relevant indicators affecting the social, political and economic situation based on the principal component analysis; 2) the normalization of indicators of the political, economic and social situation using the Harrington's approach; 3) the formation of integral indicators of the social, political and economic situation in the country based on the convolution of normalized indicators; 4) the determination of the dynamic properties of the social, political and economic situation in the country by constructing differential equations, which allows determining the existence of a bifurcation type (saddle, focus, node). The empirical study has shown that the indicator of stability of the political and social sphere of Italy was in disequilibrium and was subject to constant fluctuations. At the same time, the stability indicator of the social and economic component of Italy is characterized by an unstable state; and the external influence of negative factors will lead the system to imbalance. In Ukraine there is a stable political and economic and socioeconomic state of the system, i.e. negative impacts will lead the system to equilibrium and further positive development according to the components of the country. The development of the political and social sphere is characterized by the equilibrium state, and continues to develop according to the acquired tendency. The resulting methodological and practical developments will serve as a guide for the state authorities of the respective country for adjusting current macroeconomic policies and developing strategic plans for social and economic development.

Keywords: social economic and political development, dynamic system, bifurcation theory, phase structure.

1 Introduction

The defining features of the current development of the global economy is the rapid and significant transformation of most spheres of public life, which is due to the deepening of integration processes between countries, the free movement of capital and labor force, the rapid development of information technologies and innovations, as well as dramatic sociocultural shifts, etc. These structural changes in the global space provoke a number of shifts in national economic systems. Under these conditions, countries face new potential opportunities, growing risks and problems associated with the extensive development of the national economy, inefficient use of natural resources, uneven distribution of income between population groups, and the possible and increasing unauthorized use of personal data both in economic and political spheres. Thus, the study of bifurcation patterns in the functioning of the social, economic, and political system of a country is relevant and promising.

2 Literature Review

The issue of studying the relationship between economic, political and social processes in a country is widely reflected in the scientific literature. Despite the significant number of publications on this issue, the development of social, economic and political relations in a particular country is a dynamic process, which constantly requires in-depth research.

Scientific literature studies the influence of political instability on the development of economic and social processes by the example of many countries worldwide. In particular, (Nazeer & Masih, 2017) evaluated the impact of political instability on foreign direct investment and Malaysian economic growth based on the construction of an auto regressive distributed lag model [1]. Carmignani studied the impact of instability (including political uncertainty) on macroeconomic indicators, namely, on budget revenues, inflationary processes, and the state monetary policy [2].

Moreover, empirical studies (Bhatti, Ali, Nasir, & Iqbal, 2008) have revealed that political instability and uncertainty have a destructive effect on the processes related to the gross fixed capital formation, while democracy does not affect the level of private investment [3]. This study was conducted based on Pakistan's statistical data. (Kaplan & Akçoraoğlu, 2017) assessed the relationship between economic growth and political instability factors (corruption, government instability, internal and external conflicts, religious and ethnic tensions, democratic accountability and quality of bureaucracy) for OECD countries during 1984–2012 [4]. The calculations showed that government stability and internal and external conflicts are an obstacle to rapid economic growth, while democratic accountability, ethnic and religious tension and the quality of bureaucracy do not have a statistically significant impact on the economic growth of the OECD countries.

Ekici & Koydemir quantified the interconnection between different indicators of social capital (general trust, trust in institutions, political activity, care for others, social rules and membership in volunteer organizations), democracy and welfare of the

population [5]. Statistical data on 71 countries worldwide for 1960–1985 (Alesina, Özler, Roubini, & Swagel, 1996) have shown that the inequality of the income among the population led to an aggravation of social discontent, thereby provoking political instability. At the same time, uncertainty in the political and economic environment is reflected in the reduction of investment in the country [6].

(Kuzmenko & Roienko, 2017) studied the impact of information technology and innovation on the level of economic well-being of the population (by the example of France, Great Britain, Germany, Italy and Spain), identified probable changes in the distribution of income of the population for the next 15 years, taking into account transformations in the technological and socioeconomic environment caused by the active development of the Industry 4.0 [7].

3 Methodology

The proposed scientific and methodological approach to assessing the level of transformations in the social, economic and political development of the country involves the step-wise implementation: first, the formation of an information base of the study, which involves collecting and testing statistical data for anomaly detection using the Irwin method, and selecting relevant indicators affecting the social, political and economic situation based on the principal component analysis; secondly, the normalization of indicators of the political, economic and social situation using the Harrington's approach; thirdly, the formation of integral indicators of the social, political and economic situation in the country based on the convolution of normalized indicators; fourthly, the determination of the dynamic properties of the social, political and economic situation in the country by constructing differential equations, which allows determining the existence of a bifurcation type (saddle, focus, node).

4 Findings

The scientific and methodological approach, which consists of four main stages, was designed to assess the level of bifurcation transformations in the social, economic and political development of the country.

The first step implied the formation of an array of indicators based on the World Bank data that allows assessing the social, political and economic status of Ukraine, Italy, and France. The volume of representative indicators of influence on economic development, political status and social sphere is 18 years (2000 to 2017). The following indicators were chosen to characterize the state of the social sphere: government expenditures on the education system, the number of people aged 15–64 years, the unemployment rate, the labor force, the birth rate, refugee population by country or territory of asylum). The following indicators should describe the political situation in the country: military expenditures, the amount of public debt, the proportion of women in the national parliament, general reserves, the amount of income, excluding grants, portfolio equity, net inflows). The economic situation of a country's development can be characterized based on the following indicators: GDP growth rate,

the volume of imports of goods and services, the volume of exports of goods and services, gross savings, GDP, gross value added at coefficient value.

The time series for the anomaly detection is tested by the Irwin method [8]. Results of the step revealed that the year 2005 was abnormal for Ukraine, based on the following indicators: GDP growth rate, volume of income, excluding grants, export of goods and services; and social sphere indicator (labor force) for the year 2017. In particular, for Italy and France, 2009 and 2010 were the most abnormal based on the indicators such as GDP growth rate, portfolio equity, net inflows, government expenditures on education system, gross savings, export of goods and services, volume of import of goods and services, unemployment rate, portfolio equity, net inflows; the year 2017 for France (the proportion of women in the national parliament), for Italy (portfolio equity, net inflows).

We apply the principal component analysis to select relevant indicators of influence on the social, political and economic state of each of the analyzed countries [8]. This step has shown that the most significant indicators for Ukraine were the GDP growth rate, the share of women in national parliaments, the export of goods and services, labor force, gross savings, the population aged 15-64, total reserves, and the number of refugees. Indicators of the greatest impact on the economic and political situation in Italy and France are the GDP growth, the share of women in national parliaments, exports of goods and services, military expenditures, general reserves, imports of goods and services, income, excluding grants, public debt. Relevant indicators of Italy's social sphere (government expenditures on education, population aged 15-64, birth rate, unemployment, labor force, refugee population); for France (unemployment, government expenditures on education, labor force).

Second step. Normalization of the indicators of political status, economic development, social sphere was carried out based on the Harrington's approach. The application of this approach is necessary to convert the size of the indicators (normalization), i.e. the conversion of the values of indicators (Y_i) into dimensionless values (d_i) – the desirability function.

This method requires to consider E. Harrington's analytic function $d_i = \exp(-\exp(-Y_i))$, where Y_i – an indicator characterizing social, economic and political development, in the normal form. The conversion mechanism allows reducing all measurements from zero (poor quality) to one (high quality). The obtained results assess the quality of the indicators of influence on the political situation, social sphere and economic development of countries.

The third step involves the construction of integral indicators of the social, political and economic status of Ukraine, Italy and France, based on the convolution of normalized indicators. The method of calculating the geometric mean of the indicators is used to determine the generalized value of the social, economic and political component. The normalized value of the radius of the circle described is calculated by the formula:

$$R_i = \frac{n_{et} n_{st} n_{pt}}{(n_{et} + n_{st} + n_{pt})(-n_{et} + n_{st} + n_{pt})(n_{et} - n_{st} + n_{pt})(n_{et} + n_{st} - n_{pt})}, \quad ()$$

where R_t – the radius of the described circle of the social, political and economic state of the country (at a given time t); n_{et} , n_{st} , n_{pt} – normalized generalized indicators of economic, political and social development of the country.

The resulting data are used to form an array of values of integral indicators of the social, political and economic component and the radius of the described circle (R_t) of the countries under study. We provide an example of the calculated integral indicators for Ukraine in the period from 2000 to 2017 (Table 1). Similarly, we create an array of information for further structural modeling and the theory of bifurcation of the stability indicator (R_t) based on the integral indicators of the social sphere, political state and economic development of Italy and France.

Table 1. Integral indicators of the social, political and economic component and the radius of the described circle (R_t) for Ukraine.

Ukraine	Economic component	Political component	Social component	R_t (radius of the described circle)
2000	0.636	0.427	0.539	0.322
2001	0.622	0.438	0.526	0.316
2002	0.612	0.411	0.524	0.310
2003	0.645	0.433	0.514	0.323
2004	0.687	0.411	0.502	0.346
2005	0.616	0.453	0.522	0.315
2006	0.546	0.510	0.520	0.304
2007	0.530	0.591	0.591	0.331
2008	0.517	0.587	0.638	0.339
2009	0.485	0.563	0.636	0.330
2010	0.496	0.592	0.595	0.327
2011	0.525	0.583	0.526	0.316
2012	0.460	0.590	0.480	0.302
2013	0.415	0.571	0.494	0.293
2014	0.426	0.540	0.479	0.282
2015	0.458	0.583	0.455	0.297
2016	0.485	0.595	0.422	0.301
2017	0.517	0.619	0.392	0.311

The fourth step. The next step implies constructing differential equations, which are used to map the phase trajectories onto the chosen plane of the phase space. The phase portraits of the system of differential equations are constructed in the Mathcad program, to determine the sustainability indicator of the social, political and economic status of Ukraine, Italy, and France. This approach is based on bifurcation theory, an analysis of all possible situations on the existence of a bifurcation type (node, saddle, focus).

Differential equations are used to simulate the social, economic, and political stability. Such dependencies describe the state of the dynamic system and its nature. The right-hand side of the equation, which in itself binds independent variables, is of particular importance. We consider the equation in terms of each component of the

social, political and economic state of Ukraine, Italy, and France. Such equations establish relations between independent variables (ec, p, s – economic, political, social component), function ($R(ec), R(p), R(s)$), where R_i – the radius of the described social, political and economic state of the country (at a given time t) and its derivative $\left(\frac{d}{dt}ec, \frac{d}{dt}p, \frac{d}{dt}s\right)$. We develop a system of three differential equations for the country under study (Ukraine, Italy and France), which allows determining the behavior of the phase trajectory of the political, economic, political and social, social and economic indicators of stability.

$$\begin{cases} \frac{d}{dt}ec = 1.419 \cdot ec^2 - 0.6352 \cdot p \cdot s; \\ \frac{d}{dt}p = 0.7274 \cdot p - 0.6352 \cdot ec \cdot s; \\ \frac{d}{dt}s = 1.2504 \cdot s^2 - 0.6352 \cdot ec \cdot p. \end{cases} \quad (2)$$

$$\begin{cases} \frac{d}{dt}ec = 2.0588 \cdot ec - 2.5236 \cdot p \cdot s; \\ \frac{d}{dt}p = 1.6688 \cdot p - 2.5236 \cdot ec \cdot s; \\ \frac{d}{dt}s = \frac{0.364}{s^2} - 2.5236 \cdot ec \cdot p \end{cases} \quad (3)$$

$$\begin{cases} \frac{d}{dt}ec = 1.4142 \cdot ec^2 - 0.6848 \cdot p \cdot s; \\ \frac{d}{dt}p = 1.3044 \cdot p^2 - 0.6848 \cdot ec \cdot s; \\ \frac{d}{dt}s = 0.7456 \cdot s - 0.6848 \cdot ec \cdot p. \end{cases} \quad (4)$$

Mathematical software Mathcad, based on the system of differential equations, formalizes for each country (Ukraine, Italy and France) the phase structure – the stability indicator of the social, political and economic state of the country. We provide an example of the phase structure of Ukraine, built according to the system data (2). This model (5) analytically describes the state of the stability indicator of the social sphere, the political state and economic development of the country in the period from 2000 to 2017. Similarly, we build a phase structure for Italy and France. The mathematical formalization of the phase structure (5) analytically describes the dependence of the stability indicator and serves to construct a phase portrait. The phase portrait graphically interprets the analytical description of the dynamic system of the countries under study and illustrates the dependence of the stability indicator of social, political and economic components on the bifurcation diagram.

$$\begin{aligned}
 & (ec_0 \leftarrow ec0; p_0 \leftarrow p0; s_0 \leftarrow s0) \\
 & \text{for } k \in 0 \dots N \\
 & \text{ff} \leftarrow f(ec_k, p_k, s_k) \\
 \text{Faza}(ec0, p0, s0, dt, N) := & \left. \begin{aligned}
 & ec_{k+1} \leftarrow \lfloor ec_k + dt \cdot [1.419(ec_k)^2 + -0.6352 p_k \cdot s_k] \rfloor \\
 & p_{k+1} \leftarrow \lfloor p_k + dt \cdot (0.7274 p_k + -0.6352 \cdot ec_k \cdot s_k) \rfloor \\
 & s_{k+1} \leftarrow \lfloor s_k + dt [1.2504(s_k)^2 + -0.6352 \cdot ec_k \cdot p_k] \rfloor
 \end{aligned} \right\} \quad (5) \\
 & (ec, p, s)
 \end{aligned}$$

We consider the behavior of the dynamic system of the stability indicator of Ukraine (Fig. 1). Bifurcation diagram, according to bifurcation theory (Fig. 1 (a), (c)) describes the political and economic and socioeconomic indicators of stability. We can consider a phase portrait (Fig. 1 (a), (c)) for the presence of a bifurcation type of “stable node” with “saddle” elements. This type characterizes a stable political and economic and socioeconomic state of the system, i.e. negative impacts will lead the system to equilibrium and further positive development according to the components of the country. The situation of the political and social phase portrait of Ukraine (Fig. 1 (b)) is partial, of the “node” type with a distinct “saddle” type of bifurcation. The diagram of this dynamic system emphasizes that the political and social state of the stability indicator is ambiguous, and may change under the influence of the stimulus on the process under study.

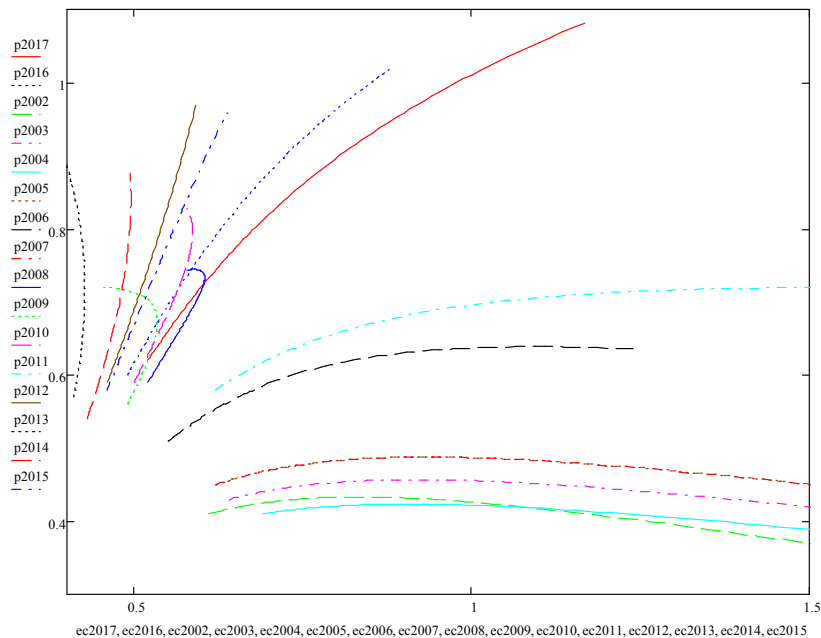

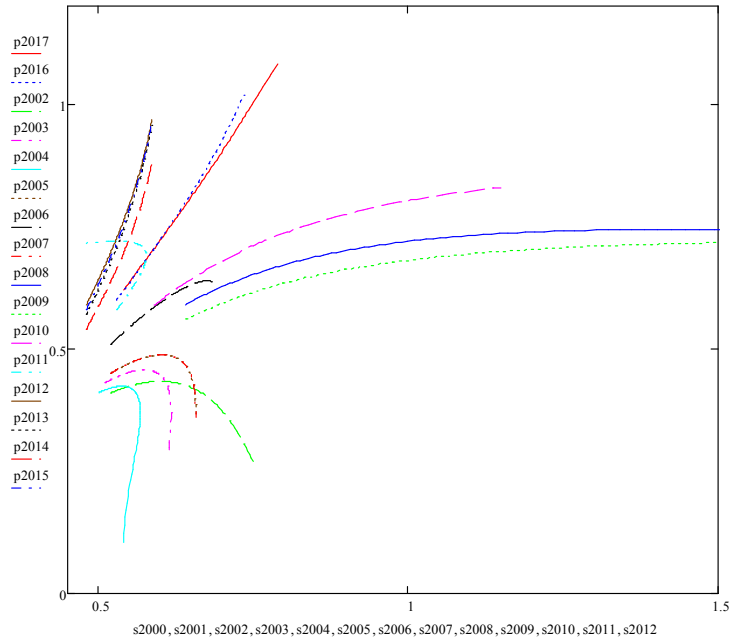

b) political and social phase portrait of Ukraine

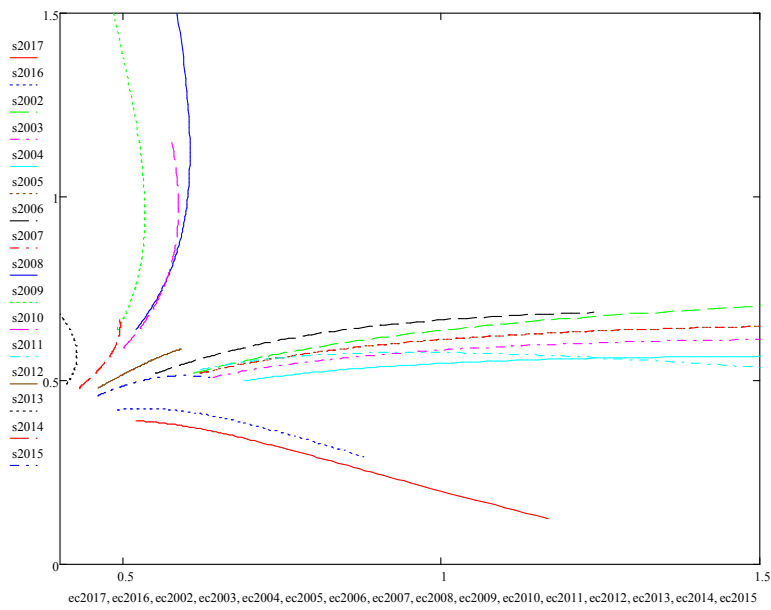

c) social and economic phase portrait of Ukraine

Fig. 1. Phase portrait of the stability indicator of the social, political and economic state of Ukraine.

The study of the phase portrait of Italy demonstrates different types of bifurcation theory. We consider the political and economic phase portrait of the country (Fig. 2 (a)), which has a clearly defined “stable node” type of bifurcation. The system of this type is in equilibrium, and continues to gain positive development under the influence of factors of the environment. We analyze the political and social phase portrait of Italy (Fig. 2 (b)), where we observe a “focus” type of bifurcation. This dynamic system of stability indicators of the political and social sphere has an unstable tendency of development. A significant change in one of the significant indicators or a number of significant values in the phase portrait of the dynamic system lead to qualitative changes, the stability indicator of the political and social sphere of Italy has a tendency to constant dynamics, unstable future development. Thus, the state of the stability indicator of the political and social sphere is in disequilibrium and subject to constant fluctuations.

Now we consider the behavior of phase trajectories on the chosen plane of the socioeconomic component of Italy. The bifurcation type of the phase portrait is a distinct “saddle” (Fig. 2 (c)).

This indicates a change in the trajectory of the stability indicator, with a significant change in the parameter and a fixed value of another parameter in the social and economic phase portrait of Italy. The bifurcation type “saddle” characterizes the dynamic system, which is in a disequilibrium state. When the system parameter of the sustainability indicator changes with time, the system is characterized by a dynamic development of the social and economic sphere. Consequently, the stability indicator of the social and economic component of Italy is characterized as unstable; the external influence of negative factors will lead the system to disequilibrium.

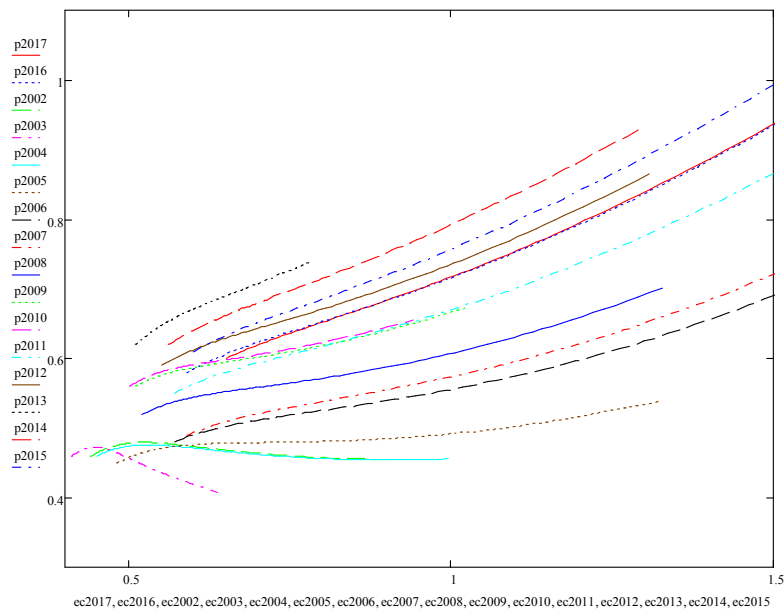

a) political and economic phase portrait of Italy

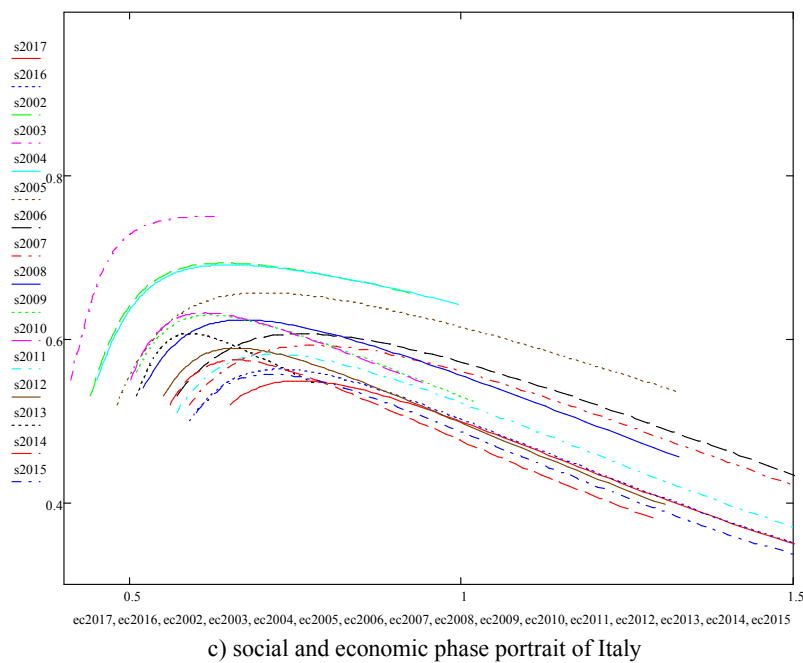
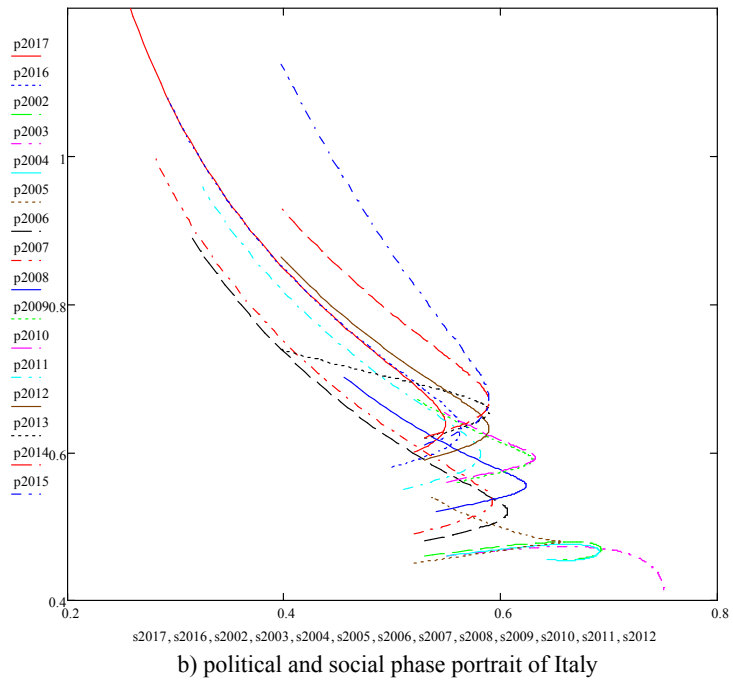

Fig. 2. Phase portrait of the stability indicator of the social, political and economic situation in Italy.

Figure 3 provides graphic interpretation of the political and social phase portrait of France. The bifurcation type is a combined, distinct “stable node” with “saddle” elements. This dynamic system is characterized by the equilibrium state, under the influence of various factors, the stability indicator is in equilibrium and continues to develop according to the acquired tendency. Similarly, we consider the political and economic, social and economic phase portrait of France. We analyze the states under study to determine the existence of a bifurcation type. There are similar trends in the dynamics of stability indicators, distinct “node” with “saddle” elements. Consequently, the stability indicator of all the components of France has the same bifurcation type and acquires stable development (equilibrium), despite the negative impact of the environment.

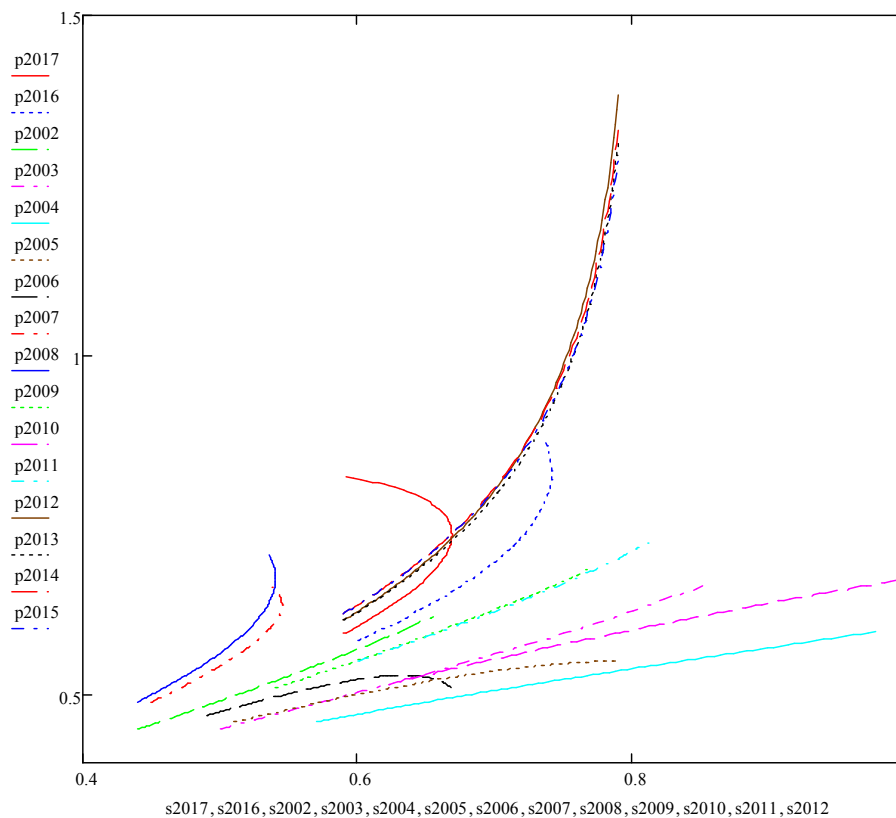

Fig. 3. Phase portrait of the stability indicator of the political and social state of France.

5 Conclusion

The study presents a general description of the bifurcation types of the stability indicator of the social, political and economic component of Ukraine, Italy and France.

Mathematical modeling of phase portraits according to bifurcation theory implies the following stages: verification of indicators, which allow assessing the social, political and economic state of the countries, for the anomaly detection; normalization of relevant indicators of influence on the analyzed components; construction of integral indicators of the social, economic sphere, political status; study of phase portraits of dynamical systems based on differential equations in relation to each component of Ukraine, Italy and France.

Bifurcation theory is being widely used in economics, the study of economic processes. The phase portrait of the stability indicator of social, political and economic components properly describes the state of the dynamic system, according to bifurcation theory. It allows analyzing the process of further behavior of the dynamic system in the event of a change in the parameter (the influence of environmental variables).

6 Acknowledgements

This research was funded by the grant from the Ministry of Education and Science of Ukraine (No. s/r 0118U003569).

References

1. Nazeer, A.M., Masih, M.: Impact of political instability on foreign direct investment and Economic Growth: Evidence from Malaysia. Munch Personal RePEc Archive. https://mpira.ub.uni-muenchen.de/79418/1/MPRA_paper_79418.pdf (2017). Accessed 20 Feb 2019
2. Carmignani, F.: Political instability, uncertainty and economics. *J. of Econ. Surv.* **17**, 1–54 (2003). doi:10.1111/1467-6419.00187
3. Bhatti, A.M., Ali, A., Nasir, M., Iqbal, W.: Impact of democracy, political instability and policy uncertainty on private investment: a case study of Pakistan. *Form. J. of Econ. Stud.* **4**, 87–101 (2008)
4. Kaplan, E.A., Akçoraoğlu, A.: Political Instability, Corruption, and Economic Growth: Evidence from a Panel of OECD Countries. *Bus. and Econ. Res. J.* **8**(3), 363–377 (2017). doi:10.20409/beri.2017.55
5. Ekici, T., Koydemir, S.: Social Capital, Government and Democracy Satisfaction, and Happiness in Turkey: A Comparison of Surveys in 1999 and 2008. *Soc. Indic. Res.* **118**(3), 1031–1053 (2014). doi:10.1007/s11205-013-0464-y
6. Alesina, A., Özler, S., Roubini, N., Swagel, P.: Political Instability and Economic Growth. *J. of Econ. Gr.* **1**, 189–211 (1996). doi:10.1007/BF00138862
7. Kuzmenko, O.V., Roienko, V.V.: Nowcasting income inequality in the context of the Fourth Industrial Revolution. *Soc. Econ. Chall.* **1**(1), 5–12 (2017). doi:10.21272/sec.2017.1-01
8. Kuzmenko, O.V., Kolotilina, O.V.: Modeling of estimating of the level of economic, social and political development of Ukraine, Italy and France in the context of optimization their relations. *Intern. Scien. and Prod. J.* **2**(39), 111–120 (2018)
9. Kouba, L., Grochova, L.: Financial Crisis, Elite Political Instability and Economic Growth in Central and Eastern European Countries. In: Stavarek, D., Vodova, P. (eds.) Proceedings

- of the 13th international conference on finance and banking, Ostrava, Czech Republic, pp. 184–195 (2012)
10. Siermann, C.L.J.: *Politics, Institutions and the Economic Performance of Nations*. Edward Elgar Publishing, Cheltenham (1998)
 11. Vasilyeva, T., Kuzmenko, O., Bozhenko, V., Kolotilina, O.: Assessing the dynamics of bifurcation transformations in the economy. *SHS Web of Conferences*. **65**, 04006 (2019). doi:10.1051/shsconf/20196504006

Investment Attractiveness Modeling Using Multidimensional Statistical Analysis

Volodymyr Shinkarenko, Maksym Matskul

Odessa National Economic University, 8, Preobrazhenska Str., Odesa, 65000, Ukraine
shinkar@te.net.ua, maksym.matskul@gmail.com

Dean Linok

Fujitsu Technology Solutions, Textorial Park, 17, Fabryczna Str., 90-344, Łódź, Poland
dean@linok.net

Abstract. The article examines the investment attractiveness of the main branches of the food industry of Ukraine as a latent variable. For the first time in this area, a combination of various methods of multivariate statistical analysis is used for research (cluster analysis and factor analysis – the principal component method). These methods made it possible to use a large number of various indicators of the activities of industries to characterize investment attractiveness. As a result, the set of the branches was divided into three groups-clusters: “leaders” are the most attractive sectors for investment, “middle peasants” are attractive branches for investment, and “outsiders” are the least attractive branches for investment. The generalizing factors (principal components), which influence the resulting factor – investment attractiveness, were found. The interrelation of the generalizing factors and initial indicators is established. As a result of the research, it was possible to make an objective assessment of the investment attractiveness (as a latent indicator) of the main branches of the food industry in Ukraine, using instead of a multitude of indicators only three latent factors.

Keywords: food industry, investment attractiveness, latent variables, cluster analysis, Principal Components Analysis.

1 Introduction

One of the global problems of the world is to provide the population with food. The agro-industrial complex and the food industry as the final link of this complex are engaged in solving this problem at the regional, state and world levels. In recent years, the food industry of Ukraine has come to the fore among the branches of the national economy. It provides the highest rates of industrial growth (with a contribution of more than 31%), more than 10% of the cost of products sold, is one of the leaders among the sectors of Ukraine in filling the state budget. It should be noted that the food industry (as part of the agro-industrial complex) is the export leader and the only sector of the

national economy with a positive balance of foreign trade. The Institute of Food Resources of the National Academy of Agrarian Sciences of Ukraine, which is a member of the Ukrainian Research and Training Consortium, deals with the economic problems of the food industry. It is necessary to note the merits of the Institute in the development of national food quality standards, their harmonization with international ones, which allows enterprises to manufacture products at the level of the best world samples. The Institute helps the food industry to master innovative technologies and promote their products in international markets. Many studies have been devoted to the study of the state and trends in the development of the food industry and its industries, including the monographs [1, 2] and the article [3]. The food industry is considered an investment-attractive industry due to the relatively short payback period of the investments and is the leader among the processing industries. In recent years, foreign direct investment in food enterprises has averaged about \$ 3 billion per year. To ensure stable growth, the food industry (especially some of its branches) requires constant technical and technological renewal and increased innovation. To solve these problems it is necessary to attract investments. The study of the investment attractiveness of enterprises and branches of the food industry of Ukraine was carried out in [4-7]. Note that among them only in article [8] an attempt was made to apply the method of hierarchical cluster analysis in the study. In recent years, in the study of various economic objects and processes, methods of multivariate statistical analysis have been widely distributed (see, for example, the monograph [9]). And in the work of one of the authors [10] by similar methods (and, additionally, regression on the latent structure) the competitiveness of food enterprises was investigated. So serious research (based on mathematical modeling) of investment attractiveness is unknown to the authors. The purpose of this article is to study the investment attractiveness (as a latent indicator) by the methods of multivariate statistical analysis.

2 Materials and Methods

The data on the performance indicators of the main branches of the food industry for 2017 are taken on the website of the State Statistics Service of Ukraine [11]. Preliminary data processing was carried out in MS Excel spreadsheets. When modeling and computing was used DELL STATISTICA software, version 12.

2.1 Cluster Analysis

Cluster analysis is one of the methods of multivariate statistical analysis. This method allows you to divide a set of objects into groups-clusters according to some latent (obviously unobservable) indicator, the values of which are manifested through a combination of signs-symptoms. The complete procedure consists of three steps:

- Step 1: Tree Clustering (Joining). At this step, the set of objects is ranked using one of the methods. As a measure of the proximity of objects, various metrics of the multidimensional feature space are used.

- Step 2: K-Means Clustering. The method allows to divide all the set of objects into clusters (more than one). The number of clusters is determined by the researcher.
- Step 3: Two-Way Joining Clustering. This step gives us the opportunity to find out which of the attributes have affected the inclusion of objects in the cluster.

Note that the methods of cluster analysis do not allow to identify generalizing factors affecting the latent index under study. Therefore, it is necessary for more comprehensive studies to apply other methods of multivariate statistical analysis.

2.2 Principal Components Analysis (PCA)

The state of most objects (especially economic) is characterized by a very large number of indicators, which are often interrelated (correlated). Therefore, there is a problem of identifying the main factors (Principal Components) that have the most significant impact on the studied result. This problem is solved by one of the methods of factor analysis – the Principal Components Analysis (PCA). This method based on the correlation matrix (matrix of paired correlation coefficients between source variables). The factorization (special representation) of the correlation matrix allows instead of the original feature space of large dimension to consider the space of the Principal Components, the dimension of which is much less than the original one. Since the Principal Components are orthogonal, the problem of multicollinearity is simultaneously solved. Note that in economic research it is necessary to solve an additional problem – the correct (from an economic point of view) interpretation of the Principal Components.

3 Results and Discussion

3.1 Cluster Analysis

The investment attractiveness of 11 main branches of the food industry of Ukraine is investigated as a latent indicator: C1 – the production of meat and meat products; C2 – processing and preservation of fish, crustaceans and mollusks; C3 – processing and preserving fruits and vegetables; C4 – the production of vegetable oils and animal fats; C5 – dairy products; C6 – production of the flour-and-cereals industry, starches and starch products; C7 – production of bread, bakery and flour products; C8 – production of other food products; C9 – production of finished animal feed; C10 – beverage industry; C11 – production of tobacco products. The variable (latent indicator) “investment attractiveness” (as the ability to effectively absorb investments) manifests itself as a result of the effect of explicit variables (indicators-symptoms) x_j ($j=1..18$): x_1 – volume (billion UAH) of the industry’s annual output; x_2 – volume (million USD) of the industry’s annual export; x_3 – current ratio (= current assets/current liabilities); x_4 – quick ratio (= (current assets-reserves)/current liabilities); x_5 – absolute liquidity ratio (= cash/current liabilities); x_6 – ratio between current receivables and payables (= receivables/current liabilities); x_7 – the ratio of current assets with own funds (= (current assets-current liabilities)/current assets); x_8 – the coefficient of ensuring own working

capital stocks (= (current assets-current liabilities) / stocks); x_9 – autonomy or financial independence ratio (= equity/liabilities); x_{10} – working capital ratio (= (current assets-current liabilities)/equity); x_{11} – concentration ratio of borrowed capital (= borrowed capital/liabilities); x_{12} – financial stability ratio (= equity / borrowed funds); x_{13} – financial leverage ratio (= long-term liabilities/equity); x_{14} – financial stability ratio (= (equity + long-term liabilities) / liabilities); x_{15} – return on assets (= net profit/assets) – the amount of net profit per unit of funds invested in assets; x_{16} – return on equity (= net income / equity); x_{17} – operating profitability; x_{18} – profitability of all activities. The source data for multivariate statistical analysis is a matrix (see Table 1).

In this table x_{ij} ; $i=1..11$, $j=1..18$ are the values of the j -th attribute for the i -th object (branch of the food industry).

Table 1. Indicators of investment attractiveness of the main branches of the food industry of Ukraine for 2017.

	x_1	x_2	x_3	x_4	x_5	x_6	x_7	x_8	x_9	x_{10}	x_{11}	x_{12}	x_{13}	x_{14}	x_{15}	x_{16}	x_{17}	x_{18}
C1	62.92	531.24	0.14	0.12	-6.28	0.09	-6.28	-38.94	0.25	-16.43	5.01	0.05	0.91	0.48	0.02	0.07	6.7	1.7
C2	3.78	26.377	1.17	0.78	0.14	0.69	0.14	0.43	0.12	1.06	0.88	0.13	1.15	0.25	0.02	0.18	2.8	1
C3	13.14	176.5	1.03	0.79	0.03	0.61	0.03	0.1	-0.01	-2.23	1.01	-0.01	-26.09	0.26	-0.06	-5.38	1.2	-4.9
C4	240.16	4605	1.02	0.66	0.02	0.51	0.02	0.05	-0.07	-0.17	1.07	-0.07	-4.36	0.25	-0.11	-1.51	-0.4	-7.1
C5	51.56	494.21	1.08	0.9	0.08	0.82	0.08	0.47	0.11	0.51	0.89	0.13	1.8	0.32	-0.05	-0.49	1.5	-4.1
C6	28.11	181.89	1.91	1.19	0.48	1.06	0.48	1.27	0.4	0.98	0.6	1.53	0.45	0.57	0	0	4.3	0.1
C7	30.7	296.41	0.97	0.7	-0.03	0.6	-0.03	-0.12	0.19	-0.1	0.81	0.23	1.37	0.45	-0.07	-0.37	4.1	-4.5
C8	9.01	1210.5	1.34	1.08	0.26	0.92	0.26	1.29	0.37	0.5	0.63	0.59	0.24	0.46	-0.03	-0.09	7.5	1.4
C9	15.84	15.55	1.08	0.61	0.08	0.57	0.08	0.18	0.09	0.7	0.91	0.1	1.85	0.25	-0.01	-0.11	0.9	-0.6
C10	46.9	209.24	1.08	0.61	0.08	0.57	0.08	0.18	0.09	0.7	0.91	0.1	1.85	0.25	-0.01	-0.11	0.9	-0.6
C11	23.52	355.73	1.89	1.1	0.13	0.03	0.1	0.1	-0.01	-0.05	1.05	-0.05	-3.37	0.25	-0.1	-1.3	-0.1	1.3

Step 1. Note that all variables (signs-symptoms) are stimulators (when more their value, then better), except x_{11} and x_{13} , which are de-stimulators (when more their value, then worse). Before conducting the multivariate statistical analysis, we will make a replacement $x_{11}^{stimulator}=1-x_{11}$, $x_{13}^{stimulator}=1-x_{13}$, which translates all signs into stimulators. For the correct ranking of object-branches, we add 2 more objects to the considered set: the “etalon” C12, for which the values of all signs are maximum, and the “anti-etalon” C13, for which the values of all signs are minimal. Note that ignoring the procedure for creating “etalon” and “anti-etalon” objects often leads researchers to inaccurate conclusions (see, for example, the article [7]). In addition, we will perform data standardization (a mandatory requirement of all multivariate statistical analysis

methods) according to the formulas: $z_{ij} = \frac{x_{ij} - \overline{x_j}}{\sigma_j}$, $j = \overline{1,18}$, where are $\overline{x_j}$ the mean

values, σ_j are the standard deviations for all objects for the j -th attribute. This transformation leads to the fact that all new variables have average values equal to 0 and standard deviations (as well as variances) equal to 1. Thus, the matrix $Z_{13 \times 18} = (z_{ij})$; $i = \overline{1,13}$; $j = \overline{1,18}$ will be analyzed. At the first step, using the “nearest neighbor” method and choosing the Euclidean distance (distance d_{ps} between p -th and

s -th objects: $d_{ps} = \sqrt{\sum_{j=1}^{18} (z_{pj} - z_{sj})^2}$) as a measure of the proximity of objects, we get the “Tree Clustering” in the form of a diagram (Fig. 1).

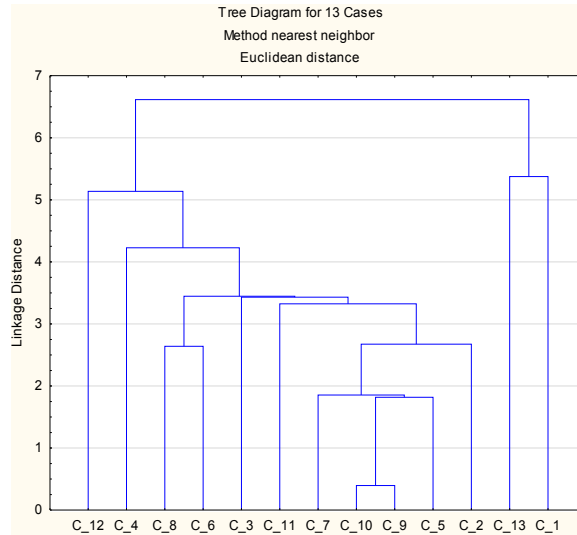

Fig. 1. Diagram of distribution the aggregate of objects (branches).

To determine the number of cluster groups into which we will break our set of industry objects, we will construct a graph of the union in steps (Fig. 2).

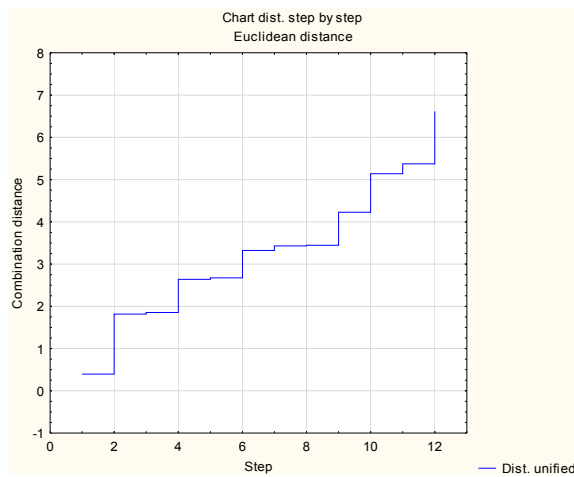

Fig. 2. Diagram of the aggregate of objects step be step.

Analyzing the above graphs, we conclude about the possibility of splitting the set of objects into 3 clusters.

Step 2. Considering the results obtained in the first step, in the second stage, using the K-means method. Set the required number of clusters, equal to three. We get:

Cluster 1 – 8 objects:

Observ.	unified
C_2	0,713673
C_3	0,685849
C_4	0,928692
C_5	0,303296
C_7	0,485469
C_9	0,347048
C_10	0,322583
C_11	0,660865

Cluster 2 – 3 objects:

Observ.	unified
C_6	0,483053
C_8	0,529164
C_12	0,799856

Cluster 3 – 2 objects:

Obser.	unified
C_1	0,633323
C_13	0,633323

Thus, we obtained a stable (robust) partition of the set of objects into 3 clusters (groups): “Leaders” – branches C6, C8, C12; “Middle peasants” – branches C2, C3, C4, C5, C7, C9, C10, C11 (“Best” of which are the branches C3, C4, C11); “Outsiders” – branches C1, C13 (see Table 2).

Table 2. Splitting the set of objects into 3 clusters.

Groups – clusters	Branch – objects
Group 1 – “Leaders”	C6, C8, C12
Group 2 – “Middle peasants”	C2, C3, C4, C5, C7, C9, C10, C11
Group 3 – “Outsiders”	C1, C13

Note that the robustness of clustering is easy to verify using discriminant analysis methods. The same methods determine the ownership of a new object to a particular cluster. This is especially important when investing in the newly built enterprises of the food industry.

Step 3. (Two-Way Joining Clustering). We set the threshold level value in such a way that our set of objects is divided into 3 blocks-clusters. As a result of the third step of the Cluster Analysis procedure, we obtain the reordered matrix of objects-attributes. The graphic image of this matrix is presented in the diagram (Fig. 3), which shows the rearrangement of variables-objects.

This matrix shows which groups of attributes and to what extent influenced the formation of clusters. At the end of this item of research we conclude that almost all branches of the food industry in Ukraine (except for sector C1) are investment attractive.

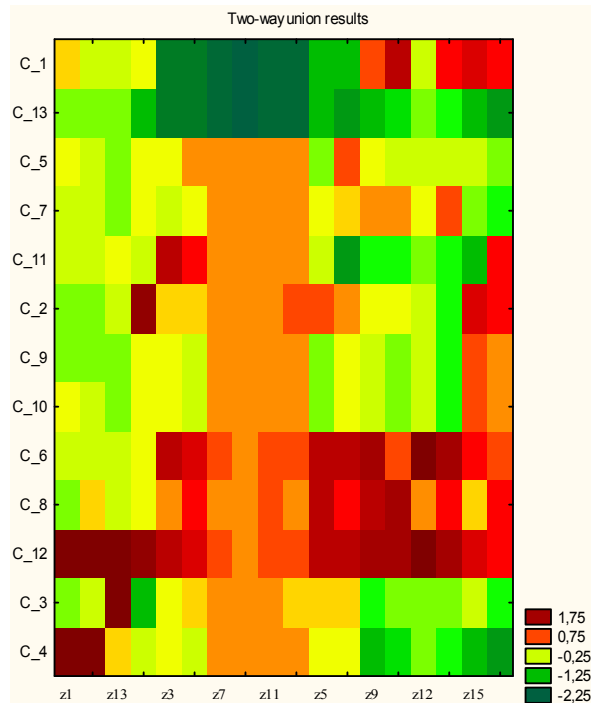

Fig. 3. The graphic image of the reordered matrix of objects-attributes.

3.2 Principal Components Analysis

In this part of the research, a correlation matrix is used, the elements of which are the pair correlation coefficients between all the variables-attributes (Table 3).

Analyzing the eigenvalues of the correlation matrix. For clarity, we use the following so-called “scree chart” (Fig. 4).

This diagram is used to highlight the Principal Components. The Kaiser method is commonly used. According to this method, components are selected that correspond to eigenvalues exceeding 1. We conclude that there are 3 main factors (Principal Components), the action of which causes more than 81% of the total variation (see Table 4).

As a result of applying the PCA, we obtain a factor solution (Table 5).

Next we find the so-called “factor solution”. At this stage, we obtain the decomposition of the Main Components (factors) through the initial variables-symptoms (see Table 6).

Independent (orthogonal) latent factors: the factor F_1 (financial condition) is appreciably loaded under influence the indicators-symptoms z_3 – z_{12} , i.e.:

$$1) F_1 \approx -0,86z_3 - 0,89z_4 - 0,89z_5 - 0,87z_6 - \\ -0,78z_7 - 0,76z_8 - 0,71z_9 - 0,78z_{10} - 0,79z_{11} - 0,79z_{12};$$

2) the factor F_2 (profitability of production) is appreciably loaded under influence the indicators-symptoms $z_{14}-z_{18}$, i.e.:

$$F_2 \approx -0,69z_{14} - 0,6z_{15} - 0,3z_{16} - 0,76z_{17} - 0,47z_{18} ;$$

3) the factor F_3 (production potential) is appreciably loaded under influence the indicators-symptoms z_1, z_2 , i.e.:

$$F_3 \approx 0,87z_1 + 0,87z_2 .$$

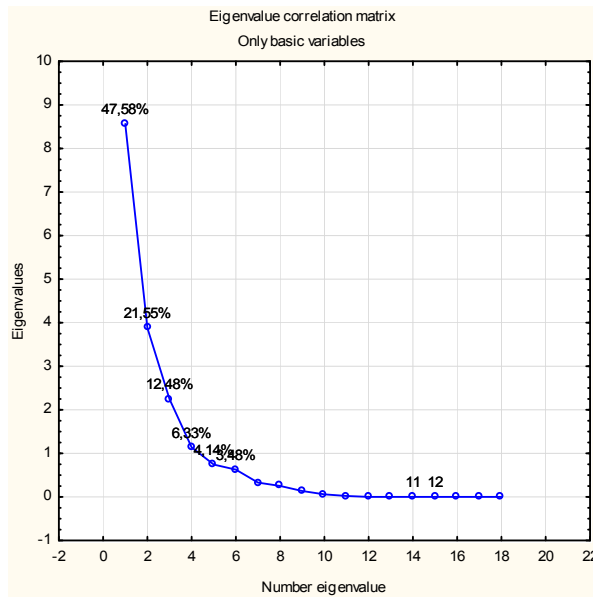

Fig. 4. Diagram of distribution the eigenvalues of the correlation matrix.

Table 3. Correlation matrix.

Correlation (Table.sta)	
Main of level p <.05000	
N=13	
Variable	z1 z2 z3 z4 z5 z6 z7 z8 z9 z10 z11 z12 z13 z14 z15 z16 z17 z18
z1	1,000 0,964 0,215 0,165 0,223 0,232 0,154 0,144 0,098 0,153 0,141 0,310 0,453 0,244 -0,006 0,342 0,150 -0,100
z2	0,964 1,000 0,272 0,261 0,367 0,292 0,209 0,199 0,144 0,201 0,200 0,341 0,481 0,261 -0,051 0,342 0,221 -0,071
z3	0,215 0,272 1,000 0,956 0,743 0,593 0,811 0,792 0,413 0,802 0,806 0,634 0,324 0,306 0,175 0,428 0,174 0,454
z4	0,165 0,261 0,956 1,000 0,814 0,700 0,834 0,819 0,468 0,816 0,837 0,628 0,343 0,356 0,150 0,387 0,267 0,387
z5	0,223 0,367 0,743 0,814 1,000 0,807 0,626 0,606 0,668 0,601 0,644 0,782 0,404 0,572 0,338 0,480 0,556 0,375
z6	0,232 0,292 0,593 0,700 0,807 1,000 0,688 0,674 0,663 0,688 0,715 0,736 0,272 0,514 0,483 0,482 0,477 0,218
z7	0,154 0,209 0,811 0,834 0,626 0,688 1,000 0,999 0,189 0,993 0,998 0,322 0,240 0,013 0,100 0,337 -0,011 0,170
z8	0,144 0,199 0,792 0,819 0,606 0,674 0,999 1,000 0,166 0,992 0,997 0,289 0,229 -0,011 0,082 0,320 -0,021 0,152
z9	0,098 0,144 0,413 0,468 0,668 0,663 0,189 0,166 1,000 0,206 0,230 0,839 0,078 0,915 0,710 0,540 0,912 0,658
z10	0,153 0,201 0,802 0,816 0,601 0,688 0,993 0,992 0,206 1,000 0,993 0,321 0,156 0,010 0,134 0,394 -0,001 0,202
z11	0,141 0,200 0,806 0,837 0,644 0,715 0,998 0,997 0,230 0,993 1,000 0,346 0,227 0,050 0,121 0,348 0,029 0,179
z12	0,310 0,341 0,634 0,628 0,782 0,736 0,322 0,289 0,839 0,321 0,346 1,000 0,318 0,829 0,514 0,492 0,643 0,441
z13	0,453 0,481 0,324 0,343 0,404 0,272 0,240 0,229 0,078 0,156 0,227 0,318 1,000 0,172 0,059 0,113 0,181 -0,001
z14	0,244 0,261 0,306 0,356 0,572 0,514 0,013 -0,011 0,915 0,010 0,050 0,829 0,172 1,000 0,491 0,361 0,870 0,433
z15	-0,006 -0,051 0,175 0,150 0,338 0,483 0,100 0,082 0,710 0,134 0,121 0,514 0,059 0,491 1,000 0,696 0,655 0,745
z16	0,342 0,342 0,428 0,387 0,480 0,482 0,337 0,320 0,540 0,394 0,348 0,492 0,113 0,361 0,696 1,000 0,515 0,627
z17	0,150 0,221 0,174 0,267 0,556 0,477 -0,011 -0,021 0,912 -0,001 0,029 0,643 0,181 0,870 0,655 0,515 1,000 0,611
z18	-0,100 -0,071 0,454 0,387 0,375 0,218 0,170 0,152 0,658 0,202 0,179 0,441 -0,001 0,433 0,745 0,627 0,611 1,000

Independent latent factors by according the significance influence on the level of investment attractive (resulting latent factor F) are put as following order: F_3 , F_2 and F_1 . For clarity, let us show on the plane of the first two Principal Components how the original features are scattered (grouped) along these components.

Table 4. Factors (Principal Components) and their contribution to the total variation.

Components	PCA -Eigenvalue	
	Eigenvalue	% total var.
1	8,564522	47,58068
2	3,879773	21,55429
3	2,245572	12,47540
4	1,140186	6,33437
5	0,744677	4,13709
6	0,625664	3,47591
7	0,328563	1,82535
8	0,251792	1,39884
9	0,136768	0,75982
10	0,059331	0,32962
11	0,022119	0,12288
12	0,001034	0,00574

Table 5. Results of PCA.

Component	PCA-Results Number components = 3 82,2001% SS					
	R2X	R2X(Cum.)	Eigenvalue	Q2	Limit	Q2(Cumm.)
1	0,462193	0,462193	9,706049	0,158949	0,126984	0,158949
2	0,250791	0,712984	5,266608	0,343864	0,136364	0,448156
3	0,109018	0,822001	2,289370	0,001094	0,147368	0,448759

Table 6. The importance of indicators in regard to the allocated principal components.

Variable	Factor scores (on correlations)		
	Factor 1	Factor 2	Factor 3
z1	-0,322763	-0,012103	0,871116
z2	-0,391765	0,007772	0,865764
z3	-0,857168	0,292811	-0,060598
z4	-0,887320	0,286191	-0,068549
z5	-0,892380	-0,050333	0,062015
z6	-0,867913	0,002402	-0,010514
z7	-0,777495	0,599929	-0,128712
z8	-0,758020	0,618527	-0,134304
z9	-0,714043	-0,647521	-0,140689
z10	-0,776692	0,578658	-0,164824
z11	-0,793686	0,570032	-0,143279
z12	-0,794195	-0,404238	0,120584
z13	-0,367898	0,060851	0,564043
z14	-0,570762	-0,689629	0,119186
z15	-0,493197	-0,598249	-0,315778
z16	-0,643265	-0,297523	-0,018541
z17	-0,544338	-0,759026	0,006649
z18	-0,517530	-0,471789	-0,419246

4 Conclusion

We developed and mathematically proved a new method for evaluating the investment attractiveness of the main branches of the food industry of Ukraine, which does not contain the subjective estimations and it takes into account many different indicators of activity of branches as possible. A mathematical model is proposed, which is based on a combination of methods of multivariate statistical analysis (Cluster Analysis and Principal Components Analysis). Economic and mathematical modeling allowed us to obtain the following results: the set of the main branches of the food industry of Ukraine divided into clusters-groups according to the latent sign “investment attractiveness” (with ranking of branches); the use of Principal Components Analysis allowed to identify and evaluate the main factors that most significantly affect the investment attractiveness. From the conducted research it follows that when deciding on investing in food industry enterprises, it is necessary (mostly) to assess its financial condition (factor F_1) and profitability of production (factor F_2).

References

1. Gadzal, J.M.: Food industry of Ukraine: strategic aspects of development. IFEAF NASU, Kyiv (2016)
2. Krysanov, D.F.: Integration of agriculture-food sector of Ukraine is in single normative space of European Union. IFEAF NASU, Kyiv (2016)
3. Kaletnyk, H.M., Kovalenko, O.V., Broiaka, A.A.: Modern progress of food industry trends and its place are in the economy of the state. Economics, Finance and Management: pressing questions of science and practice. 8, 7–26 (2017)
4. Goncharuk, A.G., Yatsyk, A.A.: On the factors of investment attractiveness of food enterprises. Ekonomika kharchovoi promyslovosti. 1(13), 34–36 (2012)
5. Koshelok, G.V.: The system of factors that affect the assessment of the investment attractiveness of the food industry. <http://dspace.oneu.edu.ua/jspui/bitstream/96.pdf> (2014). Accessed 25 Feb 2019
6. Kozak, Y., Matskul, V., Chepurna, O., Cherevko, Y., Chernyshev, V., Kyrylova, L., Podvalna, N., Ropotan, I., Shinkarenko, V., Voropai, N.: Mathematical methods and models for master of economics. <http://dspace.oneu.edu.ua/jspui/handle/123456789/6000> (2014). Accessed 24 Feb 2019
7. Shamanska, O. I.: The mechanism of increasing the investment attractiveness of food industry enterprises. Investytsii: praktyka ta dosvid. 22. http://www.investplan.com.ua/pdf/22_2012/8.pdf (2012). Accessed 26 Feb 2019
8. Yashchenko, I.O.: Investment Attractiveness of Food Industries in Ukraine. Scientific Bulletin of the National Academy of Statistics, Accounting and Audit. 1-2, 68–76 (2017)
9. Yankovy’j, O.G.: Latent features in economics. Odesa (2015)
10. Matskul, M.: A multivariate factor analysis: application for evaluating the competitiveness of enterprises. European Journal of Economics and Management. 3(6), 99–105 (2017)
11. The State Statistics Service of Ukraine. <http://www.ukrstat.gov.ua> (2019). Accessed 20 Feb 2019
12. Shinkarenko, V., Matskul, M., Linok, D.: Investment attractiveness modeling using multidimensional statistical analysis methods. SHS Web of Conferences. 65, 04007 (2019). doi:10.1051/shsconf/20196504007

Emergent Properties Manifestation in the Risk Assessment of Oil and Gas Companies

Inesa Khvostina^[0000-0002-8739-2670], Nataliia Havadzyn^[0000-0002-5662-2939],
Liliana Horal^[0000-0001-6066-5619]

Ivano-Frankivsk National Technical University of Oil and Gas, 15, Karpatska Str., Ivano-Frankivsk, 76000, Ukraine

inesa.hvostina@gmail.com, n_havadzyn@ukr.net,
liliana.goral@gmail.com

Nataliia Yurchenko

Ivano-Frankivsk National Medical University, 2, Halytska Str., Ivano-Frankivsk, 76000, Ukraine

yurchenko.n.b@gmail.com

Abstract. The article presents a study on risks in oil and gas industry and reveals their causes investigating enterprises activity as a result of emergent properties of systems. The original algorithm of risk assessment process based on emergent properties study is offered. A taxonomy approach and factor analysis are used for purposes of risk evaluation. The risk assessment consists of risks taxonomy, database structure development, identification of risks through impact factors evaluation; economic system emergent properties risks prediction, an integral risk level indicator calculation using taxonomy approach, correlation analysis of integral indicators of risk assessment, preventive measures for minimizing of negative impacts and reducing risks.

Keywords: emergent properties, taxonomic procedures, risk assessment, oil and gas companies.

1 Introduction

Oil and gas industry enterprises have a multi-layer organizational and production structure and a complex technological and production process. Making changes to structural and functional relationships, sharing of responsibilities and resources inside the enterprise and structural changes in the state economics are accompanied by a significant number of risks.

The process of risk assessment requires large amounts of information involving complex methodological approaches, adaptation of economic and mathematical models to software.

The problem areas of this study are: identification of the properties of the risks in oil and gas enterprises, modeling of emergent properties of these risks; taking into account the potential of endangered properties in risk assessment.

The essence of risk as a parameter was discussed in works of Ukrainian and foreign scientists [1, 2, 3, 4]. Oil and gas enterprises risks exposure was revealed in publications [5, 6, 7, 8, 9]. The studies mentioned above present the process of risk assessment using alternative and improved methodological approaches.

The overview of scientific publications shows insignificant differences in the views on the economic nature of the “risk” parameter. In the works [1, 2, 3, 4, 10, 11] the emphasis is on the probable negative consequences if a risk situation occurs and preventive measures to reduce them.

Some other authors [12] consider the process of business administration, taking into account the influence of various internal and external factors, including risks. The methods of dynamic optimization aimed at risk reducing were offered.

The following studies [5, 6, 7, 8] present the classification of risks in oil and gas companies' activity and suggest methodological approaches to their assessment.

2 Risks in Oil and Gas Industry

It was figured out that the main risks inherent for functioning of oil and gas companies are (Fig. 1):

- internal (financial, investment, property, human resource, management, innovation, information, production, operational, technical, technological, liquidity);
- external (political, legal, socio-demographic, ecological, market, exchange, repayment, geological, weather, globalization).

The cause of financial risk is the lack of access to capital, high inflation, fluctuations in exchange rates, an unstable financial business model and weak financial capabilities of oil and gas companies.

Low level of attraction of investment projects (involving international financial markets as well), causes investment risk. A low level of liquidity, solvency and business activity reflects property risk. Personnel risk arises as a result of the impossibility of attracting third parties in delimitation of activities (transportation of natural gas, underground storages, gas extraction as a separate activity).

Unfortunately, the oil and gas business management system in Ukraine is obsolete, inefficient and does not meet up to date international standards (management risks).

The problems in acquiring experience of managerial innovations and innovations in the oil and gas production is considered to be innovative risk.

Gaps in information systems and security, large amounts of information, the complexity of their distribution and usage make up the essence of information risk.

The complexity of the production processes of the oil and gas companies from the exploration of the deposit through exploration and exploitation drilling, the development of oil and gas fields, transportation of hydrocarbons till the processing and marketing define the production risk. Technical risk is considered to be the result of

worn-out or obsolete equipment and tools used in the production process. Management and production technologies used do not match international standards, ignore scientific and technological progress and cause technological risk.

The unstable political situation, the annexation of the Crimea and military actions in the Eastern regions of Ukraine characterize the political risk. Participation in international litigation, absence of an approved mechanism of compensation if gas is sold at regulated prices, controversial provisions in the current legislation give rise to regulatory legal risk. Socio-demographic risk is the result of low purchasing power of the population, a decrease in the birth rate and an increase in mortality, mass migration of population of working age. The impact of environmental risk appears due to the usage of obsolete equipment and production technology, improper organization and technology faults.

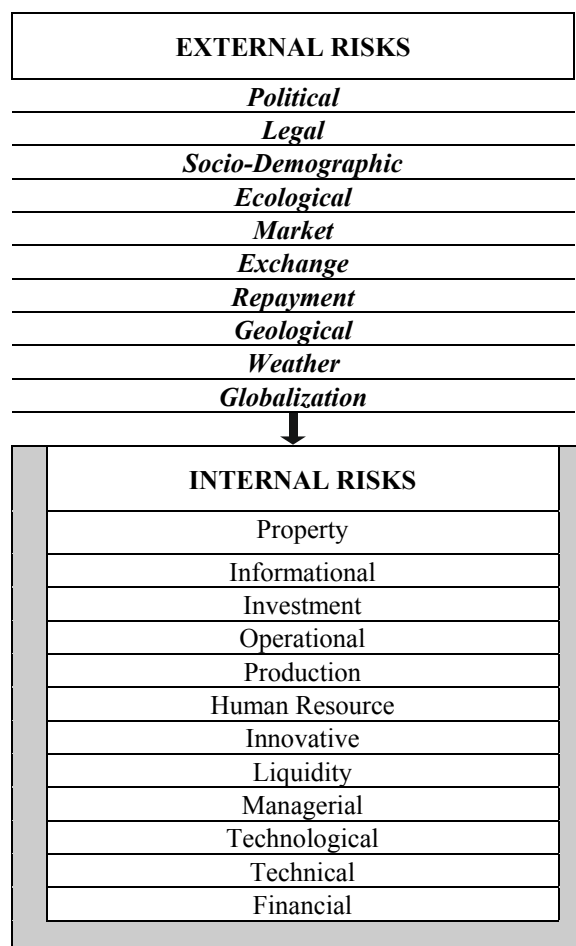

Fig. 1. Types of risks influencing oil and gas enterprises (Generalization made by authors).

Geological risks affect oil and gas extraction process, resulting in uncertainty about the productivity of deposits and associated with licensed areas where development and extraction are in the process. The situation in Ukraine has become more complicated due to the relatively low quality of geological information and obsolete equipment and technologies that can lead to increased drilling costs and reduced production rates [9].

Globalization risks can cause the disappearance of not only a particular enterprise, but also the whole industry or its separate components. Standardization of goods and the unification of consumer preferences can be both an opportunity for market expansion and a threat to an individual enterprise. It depends on its possibility to operate according to world standards or find a niche to avoid global competition. Oil and gas enterprises might face the risk of loss if global society switches to alternative energy sources.

3 Some Aspects of Risks Emergent Properties Manifestation

Any of the identified risks can cause the crisis for business entities, including oil and gas companies. Prediction of the risks caused by the emergent properties should be a prerequisite for adverse events monitoring. It allows to select and systematize factors by the field of their occurrence.

It should be mentioned, that the emergent properties manifestation arises when the risks are combined, since none of them can be considered separately from each other. In the meantime, each risk can be characterized by a wide range of indicative factors and the links between them.

The concept of emergence according to authors [13, 14] reflects such a situation, when an unexpected overall positive effect occurs as a result of the strategic interaction of selfish individuals.

Emergence of the system is characterized by the fact, that, one hand, its properties arise unexpectedly and, on the other hand, they exceed the additive properties of its separate elements. State differently, the properties of separate elements being connected to the system become the cause and the result of the sudden appearance of distinctive properties of this system. These elements had never characterized by these properties until they joined the system.

The difference between emergent properties and synergy is that the synergy effect does not exist out of bounds of properties of the elements of the system, although the overall effect exceeds the effect of each individual element. While the sign of emergence is the emergence of new properties that are not distinctive for each individual element.

Emergence is a consequence of the manifestation of at least three factors:

1. a sharp nonlinear gain of previously unnoticed property;
2. unpredictable bifurcation of any subsystem;
3. recombination of links between elements [16].

On the flip side of the coin, re-emergent property is explained as the repeated returns of negative factors, previously either unoccupied or uncontrolled. These factors usually appear over unpredictable consequences, significant financial losses or new risks.

It is important that if the risk assessment involves emergent properties evaluation, it aids identifying both future hazards and new opportunities in the development of enterprises. It becomes easier to see the emergence of new interconnections both internally and externally, and form a new approach of risk management aimed at identifying risks, reducing them and supporting self-organized tendencies. Excessive formalization in risk assessment has a very negative effect on the results of the assessment and makes it impossible to obtain a real picture for prediction the risks of enterprises.

For example to manage legal and environmental risks it is necessary to adopt international environmental quality standards in Ukraine to reduce the risk of environmental pollution and degradation.

A characteristic feature of the innovation risk of oil and gas enterprises in Ukraine is slow implementation of scientific and technological innovations. Also there is managerial risk, which is the complexity and affects several layers of the organizational and production structure of oil and gas enterprises. In combination we will get an emergent property – managerial innovation (optimization of organizational structure), which will reduce the level of risk. If we consider the combination of managerial and technological risks, then manifestations of emergent properties will result in improved management technology or more efficient management of the technological process. The phenomenon of combining legal risk with innovation is manifested in changes to the law; with management – in the implementation of international rules of law concerning oil and gas enterprises management; with technological – in the simplification of implementation (environmental norms as an example) in the technology of oil and gas production. One group of emergent risk properties can reduce the level of other. They can be the result of a combination of any risks, not just those been examined in the study.

Nowadays risk management properties change. The negative point is if we focus on the of direct-feedback system only, we will have no chance to see evolution of emergent properties. As a result, we will lose the opportunity to identify new dangers and benefits for oil and gas companies. Therefore, the risk assessment taking into account emergent properties of the management system, and not only its components (units, management decisions, resources, factors, etc.) is the result of the development and evolution of the entire risk management system.

Underestimation of the emergent or re-emergent properties can lead to major miscalculations in planning the activities in oil and gas companies, building relationships with groups of stakeholders, corporate governance, building a portfolio of projects to achieve their goals.

4 Modifying Risk Assessment Process Using Taxonomic Procedures, Factor Analysis and Taking into Account the Emergent Properties of a System

Any of the identified risks might result in the signs of a crisis at the economic activity of business entity, including oil and gas ones. Prediction of the risks caused by the emergent properties is a prerequisite for monitoring of unfavorable events. Such prediction makes it possible to choose and to systematize factors by their origin. Manifestation of emergent properties occurs when the risks are combined. The main reason of it is that none of those risks can be considered separately from each other. On the flip side of the coin, each of the risks is characterized by a wide range of indicative factors followed the wide variety of the links between them.

Taking into account the emergent and re-emergent properties is expedient in the process of risk assessment, whereas it makes possible to foretell and predict risks which oil and gas companies might be facing.

Modern qualitative and quantitative risk assessment methods allow us to identify the causes of hazards before they have influenced the oil and gas company. As a result, it becomes possible to implement the system of preventive management. Existing methods and recommendations, alone or in combination, enhance the prognostic capabilities of risk assessment approaches. However, each of these methods still ignores both emergent and re-emergent properties in risk assessment and specifics of oil and gas companies.

Within the context of that problem, the authors offer to emphasize taxonomic procedures and methods of factor analysis taking into account the emergent properties of risks.

Using such an approach enables oil and gas companies to carry out a comprehensive risk assessment which lays the groundwork for both their further assessment and forecast of their dynamics.

In accordance with the algorithm (Fig. 2), the first stage is defined as “Generating of risk taxonomy”. This stage includes:

- identifying possible causes of risk;
- definition and formation of a variety of internal and external risks affecting the economic activity of oil and gas companies.

Afterwards, the specific areas of oil and gas companies’ activity are considered. The most important of them are:

- the occurrence depth of productive formation of minerals exploration,
- drilling of oil and gas wells,
- exploration of oil and gas fields,
- extraction of hydrocarbon raw materials,
- transportation,
- processing,
- storage.

These spheres act as subjects of risk. That is why it provides insight into the process of their type identifying.

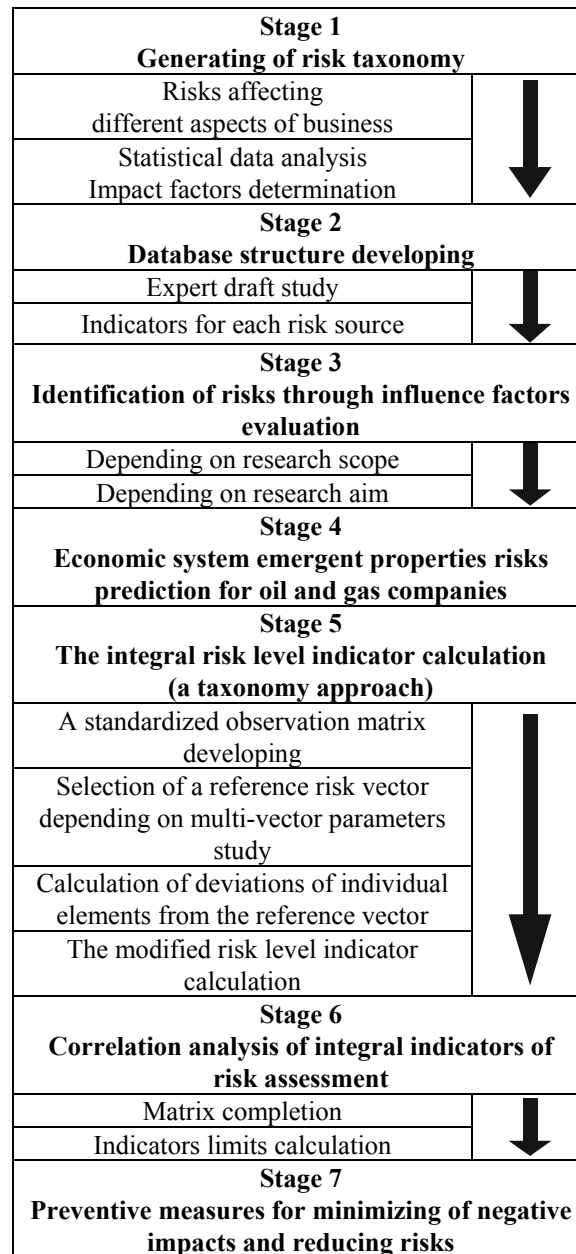

Fig. 2. Modified risk assessment process with account to emergent properties. The taxonomy method and factorial analysis are applied (authors' original development).

Further risks for different fields of activity of oil and gas enterprises are singled out. Before it the statistical sources analysis should be done and main selection indicators have to be reasoned.

At this stage a statistical database is being formed. This process involves labor-intensive work with large masses of information.

The second stage involves the database structure developing process, which can take place in two main aspects:

- based on an expert draft study. It is called “the pragmatic method” and characterized as rather subjective one;
- based on a system of indicators suitable for risk level assessing for any part the oil and gas enterprises activity or for the whole company.

An expert method refers to qualitative ones, nevertheless there are certain procedures that allow to quantify the level of risk.

As far as the indicators system is concerned, it is expedient to combine them in blocks, each of which corresponds to the sphere and specifics of the enterprise activity. That’s mean we offer to group them by the subjects of risk.

The third stage, named “Identification of risks through influence factors evaluation” also has its specific features for oil and gas companies. It depends on:

- type of business;
- the scale of the study;
- the purpose of the study.

Identification of risks makes possible to classify them in detail according to the influence factors. For that purpose, we separate stimulants and disintegrators.

On the other hand, the classification will ensure duplication avoidance. That means that we won’t have any double consideration of the properties in the evaluation system.

For the purpose of the factors selection, both those having a significant impact on the oil and gas companies and insignificant ones, it is necessary to construct a planning matrix and conduct a preliminary experiment. According to its results, the influence of factors on the production process is estimated. Properly planned experiment produces significantly more information, provides key factors identification and assessment of their impact on the output integral indicator.

For instance, taking into account the specifics of oil companies, it is important to consider such factors as the risk of production processes continuity violation, malfunction on the hardware, a significant amount of fields with hardly extractable and depleted reserves, change of wells exploitation technologies and conditions as a result of the onset of the final stage of mining and other factors causing emerging technological risks.

Emergence here (in the process of oil and gas enterprises risks assessing) is characterized by the emergence of new risks that were not foreseen in determining the causes of occurrence at the first stage.

The fourth stage is “Economic system emergent properties risks prediction for oil and gas companies”. The description of the properties of identified risks is a

prerequisite for emergent and re-emergent risk properties forecasting by the type of oil and gas companies' business activity.

The fifth stage, mentioned as "The integral risk level indicator calculation (a taxonomy approach)", includes:

- developing a standardized observation matrix; normalization procedure is performed according to the formula:

$$Z_{if} = \frac{x_{if} - \bar{x}_f}{S_f}, \quad (1)$$

where Z_{if} – standardized value;

x_{if} – value of initial factor x_f for the i -th period;

\bar{x}_f is average by factor x_f ;

S_f is standard deviation by factor x_f ;

- selection of a reference risk vector depending on multi-vector parameters study; reference selection a_f for the factor Z_f is performed by the formula:

$$a_f = \begin{cases} \max_{1 \leq i \leq m} Z_{if}, & \text{if } Z_f \text{ is the stimulant;} \\ \min_{1 \leq i \leq m} Z_{if}, & \text{if } Z_f \text{ is the disintegrator;} \end{cases} \quad (2)$$

- convolution of standardized indicators into the integral indicator $I^{(d)}$ using the distance method:

$$I_i^{(d)} = 1 - \sqrt{\sum_{f=1}^n w_f (a_f - Z_{if})^2}, \quad (3)$$

where $I_i^{(d)}$ – values of integral indicator, $i=1, 2, \dots, m$;

w_f – weights of indicators $Z_f, f=1, 2, \dots, n$;

$$\sum_{f=1}^n w_f = 1 \quad (4)$$

The distance method is quite common in various problems solving. The following studies [18, 19, 20] were conducted on the construction of the integral index within the group by the distance method. A closer look to the literature on the risk assessment process of oil and gas companies, however, reveals a number of gaps and shortcomings.

- the identification of risk level.

An expert scoring method is offered for the purpose of weight risk assessment. In this case the following rating scale is used for P_i :

- from 0 to 0.5 – low risk level;
- equal to 0.5 – medium risk level;
- from 0.5 to 1.0 – high risk level.

Choice of weight coefficients w_f becomes usually a separate non-trivial task which could be solved through the expert assessment. The solution we offer to satisfy the needs of oil and gas companies risk assessment is to use the hierarchy coefficients allowing an expert to determine weights of indicators Z_f .

Estimated values of hierarchy coefficients could be determined on the basis of critical distance d^* that is the largest distance between the nearest adjacent factors (Z_i, Z_j). This will determine the importance of the role of each factor in the entire research:

$$d^* = \max_i \min_j d(Z_i, Z_j) \quad (5)$$

To calculate the coefficient of the hierarchy all distances, which do not exceed the critical limit for each matrix factor, should be investigated according to the formula:

$$Q_i = \{(i, j) | d(Z_i, Z_j) \leq d^*, j = 1, 2, \dots, n\} \quad (6)$$

Next step is connected with summing up the received distances. For each of the elements it is chosen the factor with the biggest amount of distances:

$$k_m = \max_{1 \leq f \leq n} k_f \quad (7)$$

$$k_f = \sum_{(i,j) \in Q_i} d(Z_i, Z_j) \quad (8)$$

Thus, to determine the role, significance and position of each factor in ongoing research, we calculate the weight coefficient as the coefficient of the hierarchy according to the following formula:

$$w_f = \frac{k_f}{k_m} \quad (9)$$

The complexity of business processes at oil and gas companies' management requires systematization of statistical data array, factors, indicators, the risks as they are and their properties.

Taxonomic methods involve powerful but simple mathematical apparatus, do not require comparability of factors and properties and, on the top of that, are helpful when we need to considerate different levels of impact factors detail in the risk assessment.

The standardized observation matrix is constructed on the basis of the formed matrix of observations with adjustment to the coefficients of the hierarchy.

The standard risk vector is chosen in the variation between the maximum stimulant value and the minimum value of the disintegrator.

After it we calculate the deviation level. We have to know how much the individual elements differ from the reference vector.

The identification of the risk level reflects the trend of changes in stimulants and disintegrators, and consequently shows the resulting changes.

The matrix completion has to be done to implement of the sixth stage, mentioned as "Correlation analysis of integral indicators of risk assessment". Also here we calculate main indicators limits.

The density analysis is carried out by determining the coefficient of pair correlation. Correlation analysis provides determination of the influence degree of stimulants and disintegrators on the final result. The degree of dependence between the integral indicators is characterized by ties between them.

The final stage in the emergent properties-based risk assessment is “Preventive measures for minimizing of negative impacts and reducing risks”.

Its peculiarity is that emergent property is described both as the emergence of new properties of the risks of the oil and gas enterprises, and the disappearance of some separate risks properties after their integration into the system [17].

The approach proposed has the disadvantage – the reference values depend on the sample. It means that for different samples we may have different reference values, and, therefore, different risk level assessments.

A way out of this situation is to determine as reference values the limit values of influencing factors that identify the maximum permissible risk degree. These values can be determined either from experience or through expert assessment of factors.

Taking into account the specifics of the oil and gas enterprises of the complex, we believe that the risk assessment method focused on emergent properties of system and based on taxonomy approach and factor analysis is applicable in modern economic situation. The advisability of its application for assessing risks in oil and gas industry depends on:

1. the level of complexity, adequacy and reliability of information about activities of oil and gas enterprises;
2. different levels of detailing of factors that characterize economic activity;
3. the procedure of risk assessment explained in the article involves the construction of economic and mathematical models that take into account the qualitative, quantitative and structural characteristics of identified risks.

Prospects for further research in this direction include, on one hand, the problem of input factors choice and on the other hand, an approbation of the offered risk level assessment methodology depending on the features of the oil and gas enterprises, in particular on their specialization. Therefore, there are objective prerequisites for further research in this direction.

References

1. Vitlinskyi, V.V., Velykoivanenko, P.I.: *Ryzykologhiia v ekonomitsi ta pidpriemnytstvi*. KNEU, Kyiv (2004)
2. Granaturov, V.M.: *Ekonomicheskii risk: suschnost, metodyi izmereniya, puti snizheniya*. Delo i Servis, Moscow (2010)
3. Lukianova, V.V.: *Diahnostyka ryzyku diialnosti pidpriemstva*. Khmelnytskyi (2007)
4. Donets, L.I., Prudnikova, L.I.: *Ryzyky dyversyfikatsii hospodarskoi diialnosti pidpriemstva. Problemy i perspektyvy rozvytku pidpriemnytstva*. http://nbuv.gov.ua/UJRN/piprp_2011_1_5 (2011) Accessed 23 March 2019
5. Horal, L.T., Fadieieva, I.G.: *Finansovi aspekty innovatsiinoho rozvytku naftohazovoho kompleksu Ukrainy*. Ivano-Frankivsk (2016)

6. Nemchenko, M.Yu.: Metodicheskiy podhod k otsenke riskov neftegazodobyivayuschih predpriyatiy. *Ekonomicheskie nauki*. 10(59), 141–144 (2009)
7. Shumilova, V.M., Karataev, A.S.: Informatsionnaya model otsenki finansovyih riskov. *Sovremennyye problemy nauki i obrazovaniya*. 5. <http://www.science-education.ru/ru/article/view?id=7086> (2012) Accessed 26 March 2019
8. Ustenko, A.O., Rishhuk, L.I.: Diahnostyka ryzykiv hospodarskoi diialnosti na pidpriemstvakh naftohazovoho kompleksu. *Naukovi pratsi Natsionalnoho universytetu kharchovykh tekhnolohii*. http://nbuv.gov.ua/UJRN/Npnukht_2009_30_41 (2009) Accessed 23 March 2019.
9. Annual report of NJC “Naftogaz”. <http://annualreport2016.naftogaz.com/ua/de-mi-zaraz/osnovni-riziki/> (2016). Accessed 22 March 2019
10. Shandova, N.V.: The preventive analysis of risk factors of the development of industrial enterprises. *Marketing and Management of Innovations*. 1, 317–326 (2018). doi:10.21272/mmi.2018.1-24
11. Sudomyr, S.M.: Formation of an effective risk management system for socio-economic systems, *Visnyk KhNAU named after V.V. Dokuchaev Series of Economic Sciences*. 1, 149–153 (2018) doi:10.31359/2312-3427-2018-1-149
12. Babenko, V., Chebanova, N., Ryzhikova, N., Rudenko, S., Birchenko, N.: Research into the process of multi-level management of enterprise production activities with taking risks into consideration. *Eastern-European Journal of Enterprise Technologies*. 1(3(91)) (2018). doi:10.15587/1729-4061.2018.123461
13. Ivashuk, Yu.P.: Emerdzhentnyi instytutsiyni poriadok v ekonomitsi ta yoho povedinkovi pidstavy. *Ekonomichna teoriia*. http://nbuv.gov.ua/UJRN/ecte_2016_3_6 (2016). Accessed 23 March 2019
14. Smit, V.: Constructivist and environmental rationality in economic theory. From: *Experimental Economics* (a set of studies, the totality of which the author was awarded the Nobel Prize), pp. 419–504. Moscow (2008).
15. Geseleva, N.V., Zaritskaya, N.M.: Emergent properties of the system. *Business-inform*. 7, 93–97 (2013)
16. Grebeshkova, O.M.: Emergence in the strategic process of the enterprise. *Formation of a market economy*. 22, 129–137 (2009)
17. Khvostina, I.: Taxonomic analysis as a methodological reception of risk evaluation of oil and gas sector companies. In: *Promising problems of economics and management*, pp. 413–416. BREEZE, Montreal (2015)
18. Hryhoruk, P.M., Khrushch, N.A.: Complex assessment of level and dynamics of innovative capacity of region. *Marketing and Management of Innovations*. 3, 109–129 (2016)
19. Kalashnykova, K.M.: Zastosuvannia taksonomichnoho analizu dlia vyznachenia intehralnoho pokaznyka optymality struktury kapitalu. *Upravlinnia rozvytkom*. 2(123), 112–115 (2012)
20. Osadcha, Yu.V.: Analiz rivnia rozvytku rehionalnykh rynkiv pratsi. *Stalyi rozvytok ekonomiky*. 1(11), 142–145 (2012)
21. Khvostina, I., Havadzyn, N., Yurchenko, N.: Manifestation of emergent properties in risk assessment of oil and gas companies. *SHS Web of Conferences*. 65, 08001 (2019). doi:10.1051/shsconf/20196508001

Model for Assessment of the Financial Security Level of the Enterprise Based on the Desirability Scale

Pavlo Hryhoruk^[0000-0002-2732-5038], Nila Khrushch^[0000-0002-9930-7023]
and Svitlana Grygoruk^[0000-0003-3047-2271]

Khmelnytskyi National University, 11, Instytutska Str., Khmelnytskyi, 29000, Ukraine
violete@ukr.net, nila.ukr@gmail.com, grygoruk.svitlana@gmail.com

Abstract. Modern economic realities of Ukraine in the conditions of growing destabilizing influences of external and internal environment convincingly prove that each year the influence of various threats on the level of financial security of economic entities increases. This necessitates constant monitoring of the financial security level in order to timely detect and neutralize possible crisis phenomena as a result of its decrease. The study aims to assess the financial security level of enterprises based on the theory of comprehensive assessment. The scientific and methodical approach to design a composite index of financial security and the identifying its level based on the double use of Harrington's desirability scale is proposed. The resulting model was tested on the particular enterprise data. The proposed approach may be used for another set of partial indicators, as well as in assessing the level of financial security at the national level. The results of the study may serve as the basis for making managerial decisions on raising the business entities financial security level and public administration.

Keywords: financial security, comprehensive assessment, composite index, financial security level, enterprise, desirability scale

1 Introduction

Security is an integral characteristic of the economic system functioning, which ensures its viability, stable development and confrontation with external disturbance. Business activity at macro-, meso-level micro-levels is always subject to various risks and threats, which in a certain way affect the financial and economic results.

The global financial and economic crisis of 2008-2009 had a significant destabilizing effect on the financial and economic system of most world countries. This led to the fall of the stock market, caused the problem of decreasing liquidity and deregulation of financial institutions, reducing business, rising unemployment. For countries with a weak economy, such as Ukraine, this has led to an increase in dependence on the international monetary fund. According to assessments given in [1], as of 2018 85% of countries affected by the crisis still have production below the level that would have been achieved according to forecasted estimates taking into account pre-crisis trends.

Therefore, issues related to the assessment of financial security level of business entities in order to timely identify and neutralize the negative consequences of its reduction are relevant. The solution of this problem is possible through the use of modern cognitive tools, an important element of which is modeling. One of the most common approaches is to assess the level of financial security based on the analysis of a large number of financial and economic indicators by aggregating them into a single comprehensive index. This minimizes the loss of information, allows to get the result in the foreseeable form which convenient for further analysis, use and interpretation. Among the problems that may be solved with its serve, we can identify such as the comparison of objects studied between themselves, the identification of the objects structure, the objects classification under the level of the investigated quality, the identification of the overall quality level, the classification of new objects into a certain structure, determination of the correspondence degree of objects under study to some imaginary “ideal” and identifying the directions of situation improvement.

2 Literature Review

Issues of financial security in context of its study of both an important component of economic security, and an independent attribute of the economic mechanism of business entities, relevant for a long period of time.

Certain aspects of financial security modeling related, in particular, to the assessment of its factors, identification of threats and assessment of risks, diagnostics of the level and identification of the appropriate security class, forecasting of the financial and economic state of business entities, despite a significant number of publications and results, remain in the focus of many researchers. This is due to the complexity and multiple features of the financial security category, the dependence of its state and level on a large number of various indicators, and the high dynamism of the external environment, which is a source of new perturbations and challenges. Paper [2] presents an analysis of approaches to determine the content of the financial security category of business entities, their advantages and disadvantages.

In particular, it is focuses on the fact that key issues in ensuring financial security are the ability to protect own priority financial interests from potential and real threats of internal and external environment, realized through the achievement and maintenance of an appropriate level of financial stability, solvency and liquidity, and ensuring enterprises' financial independence.

Among the problems whose study is most often met, the problem of identifying the level of financial security, assessing and forecasting its state are taken as a special place. Side by side with this there is a task of forming a system of indicators that determine its level and state. The most common approach to solve these problems, which is presented in the scholars' papers, is based on the formation of a comprehensive indicator of financial security.

Investigation of modern issues related to the assessment of financial security on the state level is shown, in particular, in the papers [3, 5-8]. Paper [3] contains calculation of assessment of financial security level of Ukraine according to the Ukrainian

methodology for assessing the economic security [4]. The Ukraine's rating was identified by value of this estimation. Authors also used regression analysis to assess the influence of different factors on the country's financial security level. Based on the calculations, the authors made proposals to improve the methodology for assessing the financial security level aimed at reducing the subjectivity of the evaluation and improving the final result quality. The article [5] also uses the mentioned above methodology for analyzing the dynamics of comprehensive indicators that are components of Ukraine's financial security. The authors identify some of the methodology drawbacks, and propose a set of measures to increase the financial security level of Ukrainian enterprises.

Paper [6] proposed to use Corruption Perceptions Index for assessing financial security level. Paper [7] authors designed a set of models to analyze dynamics of the financial security indicators base on the multidimensional analysis statistical analysis, vector autoregression technologies, error correction models. Calculation and comparison of financial security indexes for Ukraine and some EU countries were made. Financial security subsystems which are most sensitive to the external threats are highlighted. The influence of internationalization and globalization to the financial security assurance on the national level has been studied in the paper [8].

An especially important problem for the development of the country's economy is to assess the financial security level of individual enterprises. In [9], the scoring model for financial security assessment of an enterprise is proposed based on five groups of initial indicators that reflect profitability, solvency, business activity, market stability and investment attractiveness of the business entity. Components of resulting index are calculated by the dynamic rating assessment method. The disadvantage of this approach is that it allows you to determine the financial security level in relation to the importance of this characteristic in the industry average. However, the actual level of financial security is not determined here, which complicates the results interpretation.

Another approach to use rating assessment is presented in [10]. Financial security level is assessed on three classes by the calculation of the weighted scoring estimation using the ratings of initial indicators. In our view, disadvantages this method are certain "artificiality" in the transition from quantitative values of initial indicators to the corresponding ratings, the lack of justification of the value's boundaries for determining the financial security level. This significantly limits the application of this method.

An approach to calculate comprehensive index based on the use of a linear additive convolution of partial composite indices, is become quite widespread [11-14]. In most cases, such indicators reflect certain components of the financial condition of the enterprise. Initial data for the designing partial composite indexes for each group are calculated by matching the corresponding values of the financial conditions' coefficients to their normative values. This approach also provides for definition of the minimum of financial security level of enterprises. Among the disadvantages it should be noted that the composite index goes beyond 0 to 1, which complicates the results interpretation. In addition, the authors determine the financial security level by grading the values of the corresponding composite index, but the boundaries of these levels don't have sufficient justification. Another disadvantage is that the compensation effect influences the definition of the minimal value of financial security level in general,

when the high value of the partial composite index of financial security for one group of initial indicators can overlap the low values for other groups.

Regression models for assessing the of enterprises financial security level are proposed in [15, 16]. They allow to identify the influence of the most significant factors on the final result, which helps to determine the direction of making managerial decisions to increase security. In addition, such models can be used to assess the value of a financial security index in subsequent periods. In our view, such models have a limited application because number of predictors including to the model is limited by the volume of initial data. Furthermore, they don't allow to assess the financial security level.

The results of this review make it advisable to develop an own approach to assessing the enterprises financial security level. It aimed to eliminate the disadvantage inherent in the methods described above, in particular, to reduce the compensation effect from overrun normative values by indicators, as well as to identify and justify the financial security levels.

3 Problem Description and Methodology

To assess the financial security level, we propose an approach also based on the calculation of the composite index. Let's consider the essence and peculiarities of each stage of the proposed approach.

The first stage of its design is the formation of a set of initial characteristics of financial security, $X = \{X_1, X_2, \dots, X_m\}$, m – the number of characteristics, each of which in this case is an indicator measured on a metric scale. The number of such indicators, the feasibility of their distribution into groups is determined by the specific objectives of the study. A large number of indicators reduces the impact of each component on the variability of the final result. In addition, the weight coefficients values for the components of the composite index may be statistically insignificant. Instead, too few of them can take into account not all the features of components of financial security.

In the case of a large number of initial indicators, it is expedient to use a sequential convolution procedure in which they are initially grouped according to certain characteristics. At the same time, following conditions are provided for each group:

1. The indicators of each group should reflect one characteristic of the investigated phenomenon.
2. There must be high correlation between the indicators within the group.
3. The correlations between the indicators of different groups must be insignificant.

So, in this case, the correlation matrix of the initial indicators serves to group the initial data.

Another way to group indicators is to combine them using meaningful analysis. Partial composite index is calculated for each group. The final composite index is formed from these partial indexes. This approach is predominantly used in the reviewed above papers [9-14]. It should be noted that second and third requirements described above may not be met.

The formation of a synthetic generalized index for each group can also be done using multidimensional analysis like factor analysis or principal component analysis. These methods are particularly effective when there are high correlations between indicators within the group. Also, their advantage is that they allow to determine the importance (or weight) of each component of group composite index.

One more way for processing group of initial indicators is to select from each group the most “informative” indicator using heuristic methods of diminishing the dimension. However, the part of the information is necessarily lost in the final result in this case. In addition, these methods have a high level of subjectivity in determining the appropriate indicators.

Next stage is to shape vector of indicators $\mathbf{q}=\{q_1, q_2, \dots, q_n\}$, that are functions from set of initial indicators and aimed on the assessment of separate components of financial security. The vector \mathbf{q} is characterized by the fact that the influence of the measurement units of the initial indicators is removed from it, and it has a direction of positive change its values in accordance with increase of values of its components. A typical situation is when each indicator of the set X somehow transforms to the component of the vector \mathbf{q} : $q_i=f(X_i)$, $i=1, 2, \dots, n$, $m=n$.

Additionally, the components of this vector should meet the normalization condition, that is, its value must be on the interval $[0; 1]$. It simplifies further analysis of the comprehensive assessment results of financial security.

The choice of the form of a synthesizing function $Q=F(w_1, w_2, \dots, w_n, q_1, q_2, \dots, q_n)$ is further made. This procedure puts into compliance the vector \mathbf{q} to the corresponding value of composite index Q , which reflects the latent characteristic of the investigated phenomenon, in this case – an assessment of the level of financial security. Aggregation of the vector \mathbf{q} into the composite index is carried out taking into account the vector of some positive parameters $\mathbf{w}=\{w_1, w_2, \dots, w_n\}$, which represent the significance of the individual components of the vector \mathbf{q} . Usually a standard condition $w_1+w_2+\dots+w_n=1$ imposed additionally on its components which gives grounds to conclude about the relative importance of each component of the composite index.

In the case of grouping initial indicators, for each group we can use different aggregation procedure depending on the type of initial indicators and the way of their transformation into a \mathbf{q} vector. The most common method is the convolution (additive or multiplicative) and the distance method. There is no reason to argue that using one type of convolution can produce better results than using another one. Usually, the choice of a concrete convolution type is determined by the problems solved, and the values that initial (normalized) data can take. In our study, we propose to use multiplicative convolution. The justification for this choice will be given below.

Last stage is meaningful interpretation of results. It involves establishing a match between the estimated values of the composite index and the financial security level. The identifying the number of levels, their correspondence to certain ranges of the composite index values and the justification of ranges boundaries form a separate non-trivial issue. In our view, the solution of this problem should be based on certain tools, in particular, use of cluster analysis, iterative procedures for calculating index ranges' boundaries, scale of desirability, etc. Last approach is used in our studies.

4 Findings

In the framework of the considered approach to design financial security composite index, according to the analysis of previous studies results [9-15], to form the information base of the study, we propose to select as initial indicators ones that characterize the enterprise financial conditions. In so doing we include to the initial set only those indicators which have known normative values. The basis for further calculations is the assumption that the equality of all indicators to their normative values corresponds to high (proper) level of financial security.

To obtain a vector \mathbf{q} , which will serve as the basis for designing an composite index, we use a five-step procedure based on the use of E. Harrington's function $H(Z_i)=\exp(-\exp(-Z_i))$ and its appropriate desirability scale [17], where Z_i is the value of the initial indicator on the scale of partial indices Z . The value of the function $d=H(Z)$ form a desirability scale.

In the first step, it is necessary to establish a correspondence between the values of the scale Z of the E. Harrington's function and the values of the initial index X_i , $i=1, 2, \dots, n$. Based on the graph of the function $H(Z)$ (Fig. 1), we can conclude that $H(-2)\approx 0$, $H(5)\approx 1$. Therefore, the effective values range of partial indicators scale is the range $[-2; 5]$.

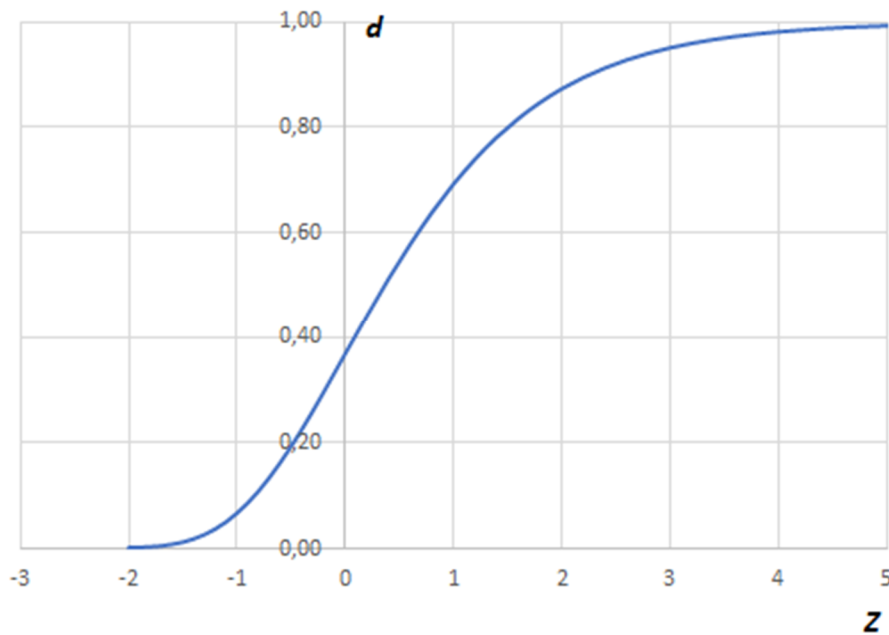

Fig. 1. Harrington function graph.

Let's use this fact, putting the value $Z = Z^* = 5$ in line with the normative value X_i^* of each initial indicator, $i=1, 2, \dots, n$. This means that at the normative value of the X_i , the

highest value on the desirable scale d is reached. The value X_i^* of the initial indicator, for which the critical level of desirability $d=0$ is reached, corresponds to the value $Z = Z^* = -2$. Usually $X_i^* = 0$. So, the coefficient k_i , $i=1, 2, \dots, n$, for transformation of the values of the indicator X_i to the values of the scale of partial indices Z_i is calculated by the formula:

$$k_i = (Z^* - Z_i) / X_i^* \quad (1)$$

In the second step, we calculate the value of Z_i , $i=1, 2, \dots, n$, by the formula:

$$Z_i = k_i X_i + X_i^* \quad (2)$$

In the third step, we find image d_i of indicator X_i on the desirability scale using corresponding value of the scale of partial indicators Z_i , $i=1, 2, \dots, n$:

$$d_i = H(Z_i) \quad (3)$$

In the fourth step, we identify the "level" of the indicator X_i , $i=1, 2, \dots, n$, on the desirability scale in accordance with Table 1 [17].

Table 1. The connection between the quantitative values of the desirability scale and its qualitative levels.

Qualitative expression of desirability	The range of quantitative values on the scale of desirability
Very good	0.80..1.00
Good	0.63..0.80
Satisfactorily	0.37..0.63
Badly	0.20..0.37
Very badly	0.00..0.20

In the fifth step, we calculate the value of indicator q_i as middle of an interval that corresponds to the level of desirability of the indicator X_i :

$$q_i = (d_{2i} + d_{1i}) / 2 \quad (4)$$

where d_{2i} , d_{1i} are right and left boundaries of desirability scale range, which contains calculates value d_i .

To design composite index Q of the financial security, we propose to use weighted multiplicative convolution:

$$Q = \prod_{i=1}^n q_i^{w_i} \quad (5)$$

Such a choice is justified by the fact that it is consistent with the rule of constructing a comprehensive index proposed by E. Harrington [17]. Also, it should be noted that among the values of q_i there are no zero ones, which makes it impossible to obtain the zero value of the resulting function Q . Otherwise, the zero values would completely reduce the influence of other indicators on the result.

To identify the financial security level, we again use desirability scale by the determining the range on the scale d which contains value of index Q . In this case, we establish an interpretation of financial security levels in accordance with Table 2.

Table 2. The relationship between the quantitative values of composite index Q and financial security levels.

Qualitative expression of financial security level	The range of quantitative values of the composite index Q
High	0.80..1.00
Normal	0.63..0.80
Satisfactory	0.37..0.63
Critical	0.20..0.37
Crisis	0.00..0.20

In our opinion, presented approach has such advantages.

1. Results don't depend from the simple which is used to assess the financial security level. Transformation of initial indicator values is determined in relation to its normative value, and not in relation to the maximal or the minimal sample values.
2. Calculating the values of the composite index by the proposed algorithm reduces compensation effect, when exceeding the normative value of one indicator will affect deviations from the normative value of another indicator.
3. It allows to establish a reasonable financial security level.

Among the disadvantages it should be noted that not all indicators that characterize the financial condition, have justified normative values. Some indicators have positive features as the characteristics of their dynamic, that usually increase their values during the time.

Let us test the proposed approach under the data of the private joint-stock company "Derazhnia dairy Plant". Initial data for the calculation was provided by annual financial reports for 2016 and 2017 [18].

We selected follow financial indicators for calculations, which presented in the Table 3.

Table 3. The list of initial financial indicators and their normative values.

	Financial indicators	Normative value
X_1	Absolute liquidity ratio	0.2
X_2	Quick liquidity ratio	0.6
X_3	Current liquidity ratio	1.0
X_4	Total solvency ratio	2.0
X_5	The ratio of short-term receivables and payables	1.0
X_6	Autonomy ratio	0.5
X_7	The financial stability ratio	1.0
X_8	The maneuverability of equity ratio	0.7
X_9	The ratio of coverage of inventories and costs	0.8
X_{10}	The financial stability ratio	0.8

Values of indicators calculated using the financial reports are shown in the Table 4.

Table 4. The values of initial data.

Indicator	Indicator's value	
	2016	2017
X_1	0.01	0.01
X_2	0.41	0.27
X_3	1.03	0.93
X_4	1.75	1.58
X_5	0.20	0.14
X_6	0.43	0.37
X_7	0.75	0.58
X_8	-0.16	-0.20
X_9	-0.22	-0.18
X_{10}	0.51	0.40

We use the formulas (1) and (2) to calculate the values of the indices on the Z -scale. Results are shown in Table 5.

Table 5. The values of indicators on Z -scale and d -scales.

Indicator	Indicator's value		Appropriate value on the scale d	
	2016	2017	2016	2017
Z_1	-1.71	-1.75	0.00	0.00
Z_2	2.84	1.13	0.94	0.72
Z_3	5.18	4.51	0.99	0.99
Z_4	4.14	3.52	0.98	0.97
Z_5	-0.61	-1.01	0.16	0.06
Z_6	4.02	3.13	0.98	0.96
Z_7	3.28	2.04	0.96	0.88
Z_8	-3.55	-4.01	0.00	0.00
Z_9	-3.95	-3.62	0.00	0.00
Z_{10}	2.46	1.48	0.92	0.80

In the next step, we find by the formula (3) the values of the indicators on the desirability scale d . The results are also shown in Table 5.

Then we use formula (4) to identify components of the vector \mathbf{q} . Results are presented in the Table 6.

Considering the initial indicators weights are the same ($w_i=0.1$, $i=1, 2, \dots, 10$), we calculate the value of the composite index Q . As a result, we obtain: $Q_{2016}=0.36$, $Q_{2017}=0.36$. According to Table 2, the financial security level of the studied enterprises during the investigated period is identified as critical but close to satisfactory.

We made calculations to assess the financial security level for the same data in accordance with the method presented in [11]. According to it, a quantitative

assessment of this level may be calculated according to the set of indicators identified in this study. As a result, we obtained such estimations of the financial security level: $R_{FS\ 2016} = 0.459$, $R_{FS\ 2017} = 0.363$. At the same time, the minimum required level of financial security, as determined by the paper's author, in this case is 10 (according to the number of initial indicators for which the calculation was made).

Table 6. The values of components of the vector \mathbf{q} .

Indicator	Indicator's value	
	2016	2017
q_1	0.10	0.10
q_2	0.90	0.72
q_3	0.90	0.90
q_4	0.90	0.90
q_5	0.10	0.10
q_6	0.90	0.90
q_7	0.90	0.90
q_8	0.10	0.10
q_9	0.10	0.10
q_{10}	0.90	0.72

Consequently, we can state that the financial security level assessed significantly deviates from the minimum required level established by this method and can be classified as critical. This result is consistent with what was obtained in our study.

5 Conclusions

Assessing the financial security level is an urgent problem both at the state level and for individual business entities. The conducted studies showed the widespread use of the comprehensive assessment methodology to solve this problem. The article considers an approach to assessing the financial security level of an enterprise by designing a composite index. Its calculation contains four stages. The first stage involves identifying the set of initial indicators that characterize financial security. In the second stage, selected indicators are reduced to a single form by removing the measurement units and transformation into indicators-stimulants. These calculations use the normative values of the selected indicators, the E. Harrington's function and desirability scale. In the third stage, the convolution of obtained new indicators is carried out. Taking into account the procedure of transformation of indicators in the second stage, we proposed and justified the use of convolution in the multiplicative form. The fourth stage is devoted to the interpretation of the result, that is, to identify the financial security level. To do this, we used the desirability scale again. The proposed four-stage procedure, qualitative expression of financial security levels and their appropriate ranges of quantitative values of the composite index Q are the subject of scientific novelty of this study.

Practical testing of the presented approach was carried out according to the data of the private enterprise “Derazhnia dairy Plant” and was compared with the results obtained by another approach. The final conclusions were similar.

The proposed approach doesn't depend on the number of initial indicators and the direction of their positive change. In the case that their number is too large to evaluate the impact of an individual component, the article proposes ways to solve this problem.

The results of the study may serve as the basis for making managerial decisions on raising the business entities financial security level and public administration.

References

1. Chen, W., Mrkaic, M., Nabar, M.: Lasting Effects: The Global Economic Recovery 10 Years After the Crisis. <https://goo.gl/ZAd2uG> (2018). Accessed 14 Mar 2019
2. Davydenko, N.M.: Genesis of enterprise financial security. *Economic Processes Management: International Scientific E-Journal*. 2. http://epm.fem.sumdu.edu.ua/download/2015_2/2015_2_3.pdf (2015). Accessed 14 Mar 2019
3. Haber, J.A., Bukhtiarova, A., Chorna, S., Iastremska, O., Bolgar, T.: Forecasting the level of financial security of the country (on the example of Ukraine). *Investment Management and Financial Innovations*. **15**(3), 304–317 (2018). doi:10.21511/imfi.15(3).2018.25
4. Pro zatverdzhennia Metodychnykh rekomendatsii shchodo rozrakhunku rivnia ekonomichnoi bezpeky Ukrainy. Nakaz Minekonomrozvytku Ukrainy vid 29.10.2013 No 1277. (On approval of the Methodical Guidelines on the calculation of the level of economic security of Ukraine. Order of the Ministry of Economic Development and Trade of Ukraine on October 9, 2013 No 1277). <http://consultant.parus.ua/?doc=03WN62B99B> (2013). Accessed 22 Apr 2019
5. Mihus, I.P., Akimova, L.M., Harnyk, O.A.: Diagnostics of the state of financial security of Ukraine. *Scientific Bulletin of Polissia*. **3**(15), 12–18 (2018). doi:10.25140/2410-9576-2018-3(15)-12-18
6. Blakyyta, G., Ganushchak, T.: Enterprise financial security as a component of the economic security of the state. *Investment Management and Financial Innovations*. **15**(2), 248–256 (2018). doi:10.21511/imfi.15(2).2018.22
7. Guryanova, L.S., Klebanova, T.S., Milevskiy, S.V., Nepomnyaschiy, V.V., Rudachenko, O.A.: Models for the analysis of the state's financial security indicators dynamics. *Finansovo-kredytna diialnist. Problemy teorii i praktyky*. **1**(22), 254–264 (2017)
8. Han, R.: Financial Internationalization and Financial Security Issues. *Open Access Library Journal*. 1–7. https://www.researchgate.net/publication/327626128_Financial_Internationalization_and_Financial_Security_Issues (2018). doi:10.4236/oalib.1104874. Accessed 16 Mar 2019
9. Krakos, J.B., Razgon, R.A.: Upravlinnia finansovoiu bezpekoiu pidprijemstv (Management of enterprises financial security). *Ekonomika ta upravlinnia pidprijemstvamy mashynobudivnoi haluzi*. **1**(1), 86–97 (2008)
10. Azarenkova, G.M., Bondarenko, I.I., Azarenkov S. G.: Zabezpechennia finansovoi bezpeky pidprijemstva yak osnovy yoho efektyvnoi diialnosti (Providing financial security of the enterprise as a basis for its effective activity). *Finansovo-kredytna diialnist. Problemy teorii i praktyky*. **1**(16), 168–176 (2014)

11. Blazhevich, O.G.: Finansovaya bezopasnost predpriyatiy: opredelenie minimalno neobhodimogo urovnya (Financial security companies: the definition of the minimum necessary). *Finansyi. Banki. Investitsii.* **3**(8), 25–31 (2010)
12. Bilomistna, I.I., Adahovska, L.V.: Vyznachennia minimalnoho rivnia finansovoi bezpeky pidpriemstva (Determining the minimum of financial security enterprise). *Stalyi rozvytok ekonomiky.* **1**(26), 61–68 (2015)
13. Lynenko, A., Konyev, V.: Otsiniuvannia finansovoi bezpeky uchasykiv obiednannia pidpriemstv (Assessment of financial security of enterprises association participants). *Agricultural and Resource Economics: International Scientific E-Journal.* **3**(4), 85-96. <http://www.are-journal.com> (2017). Accessed 15 Mar 2019
14. Delas, V., Nosova, E., Yafinovykh, O.: Financial Security of Enterprises. *Procedia Economics and Finance.* **27**, 248–266 (2015)
15. Bilomistna, I., Bilomistnyi, O., Oliynyk, O.: Diahnostuvannia finansovoi bezpeky pidpriemstva (Diagnostics financial security of the company). *Socio-Economic Problems of the Modern Period of Ukraine.* **1**, 623–636 (2014)
16. Zwolak, J.: The financial security of smalland medium-sized enterprises in Poland. *Ekonomski Pregled.* **68**(4), 399–412 (2017)
17. Harrington, E.: The desirability function. *Industrial Quality Control.* **21**(10), 494–498 (1965)
18. Rehuliarna informatsiia (XML). Pryvatne aktsionerne tovarystvo “Derazhnianskyi molochnyi zavod” (Regular information (XML). Private Joint-Stock Company “Derazhnia Dairy Plant”). <https://smida.gov.ua/db/emitent/report/year/xml/show/110792> (2018). Accessed 20 Mar 2019
19. Hryhoruk, P., Khrushch, N., Grygoruk, S.: Model for assessment of the financial security level of the enterprise based of the desirability scale. *SHS Web of Conferences.* **65**, 03005 (2019). doi:10.1051/shsconf/20196503005

Non-linear Forecasting of the State of a Socio-eco-oriented Innovative Economy in the Context of Systemic Crises

Sultan Ramazanov^[0000-0002-5936-7830], Bogdan Tishkov

Kyiv National Economic University named after Vadym Hetman, 54/1, Peremohy Ave., Kyiv,
03057, Ukraine
sramazanov@i.ua, tishcov_b@ukr.net

Oleksandr Chernyak^[0000-0002-0453-0063]

Taras Shevchenko National University of Kyiv, 60, Volodymyrska Str., Kyiv, 01033, Ukraine
chernyak@univ.kiev.ua

Abstract. The paper deals with the problem of sustainable development and innovative integral modeling and forecasting approach in the management of technogenic objects and processes (TOP) as a system of socio-eco-economic and humanitarian type (SEEH). Based on the use of information and innovation technologies in order to forecast the non-linear dynamics of eco-economic and socio-humanitarian systems, integrated stochastic models of objects and processes were developed and studied, suitable for the conditions of systemic crises. The paper handles the aspect of integration of 4 business and functioning areas of the modern complex systems. It proposes a general conceptual integrated model, generalized synergetic model of dynamics, considering different uncertainty (stochastic and chaotic components). The paper examines the aspects of integration of multiple business areas and sectors of the modern complex systems functioning and developing under the present conditions of non-linearity, instability and crises. An integrated stochastic non-linear phase-space growth dynamics model was developed and studied to forecast the development of the state of an innovative economy. The paper looks into the aspects of activity management of the modern complex systems functioning and developing under the present conditions of instability.

Keywords: stochastic, dynamics, model, nonlinear, crises, forecasting, control.

1 Introduction

The global goal of this research is to create a general conception, principles, methodology, methods, models and information technologies and systems for making managerial decisions for sustainable, safe, secure and viable development of economy, environmental economy and socio-humanitarian systems under the conditions of uncertainty, risks, threats and crises [1-8].

The knowledge of the scientific potential on economics was assigned to V. Heyets [9], T. Klebanova [10], I. Lyashenko [11] and others. Methodology of regional scientific and technological progress (STP) in aggregative models in economics was described by S. Aywazyan, M. Afanasyev, V. Rudenko [12], G. Kleiner [13]. The problems of mathematical modeling of complex economical systems of ecology and economy were researched by a lot of academics, such as D. Ford, V. Leontyev [14], J. Tsukui, J. Murakam [15], V. Brock [16], O. Tahvonen, J. Kuuluvainen [17]. The most comprehensive investigation was fulfilled by Ya. Vagapova [18], which is a description of the national economy with a system of nonlinear differential equations, based on the A. Moiseyev model [19].

The conception of sustainable, safe, secure and viable development provides for a change in the paradigms of the traditional economy, humanization and ecologization of its core principles, search for general approaches and coordination between the development conceptions of environmental and economic systems.

The problem of sustainable development features the following aspects: systemic, synergetic, environmental, economic, mathematical, informational, philosophical, legal, educational, etc. The paper handles the aspect of integration of 4 business and functioning areas of the systems: socio-eco-economic and humanitarian, including spiritual-moral and cultural technologies. The sustainable development paradigm requires transition from the investigation of separate functioning isolated systems to the investigation of integral evolving systems, actualization and strengthening of system-synergetic links of an open system and its environment. The existing "monodisciplinary" conceptions, linear static models, reproductive-representative methods (reflecting the linearity of our knowledge), profitability and optimality criteria should give place to interdisciplinary, system-synergetic, evolutionary non-linear models and methods of forecasting and knowledge acquisition, management (reflecting the non-linearity and non-Gaussian character of the laws of nature and society), criteria of rationality, local optimality, and correspondence to the "common sense". "Interdisciplinary" paradigm is understood not in the intuitive, technocratic relationship of disciplines, accumulation of quanta of knowledge and skills, but in the actualization of individual and public intellect, education and learning of new self-organized and sustainable structures [19-25].

Under the current complex conditions and as the modern economy advances, a need arises to consider its forecasting problems in a new fashion. This is connected with the increased influence of globalization processes and uncertainty and risk factors on the economy and business performance of individual countries and regions. Existing forecasting methods and models rely, to a considerable extent, on the application of econometric models. This paper analyzes the opportunities of development forecasting on the basis of the approximation of the integral stochastic growth model in the form of recurrent equations formed taking into account the increment properties of the Wiener random processes. This considers only current or initial state of the economy.

Only integration of the modeling methods for socio-economic, environmental, cultural and spiritual and other processes will ensure sustainability and viability of development of the entire system [1-5].

Also, note that a system-thinking and active person usually forecasts and considers his/her performance results, compares his/her capabilities, considers environmental interests, those of future generations and the need for noospheric development.

The purpose of the paper is to develop and investigate problems of non-linear forecasting, in particular on the basis of the integral socio-eco-economic stochastic model of the dynamics of technogenic objects and processes functioning under the conditions of systemic crises.

The problem of modeling, forecasting, optimal management and decision making in socio-ecological-economic systems and in science as a whole is the main and urgent. The purpose of this work is to study the methods, principles and models for forecasting and management used in various socioeconomic processes and systems, as well as the introduction of a new class of models for solving problems of modeling and prediction of socio-ecological and economic processes. The work is based on the analysis of modern methods of dynamic modeling and forecasting of various processes and systems [1-5].

2 Key Findings

In this paper, technogenic objects and processes (TOP) mean technogenic production enterprises (TPE) or technogenic regional production operations (TRPO), or technogenic regions (TR), technogenic economic object (TEO), etc. Let us designate all these as TOP.

Under the current conditions of instability and crises, the problem of developing analysis, modeling, forecasting and decision-making methods and technologies for sustainable development of viable socio-economic systems is becoming even more topical. These systems are characterized by the complexity of the structure and behavior, synergeticity, non-linearity and have other “NO” and “MANY” factor characteristics.

Moreover, another very important problem includes investigation of systems with integral properties, i.e. systems including in their structure socio-economic and humanitarian subsystems (SEEH) as the systems of the future (noospheric type systems). Local production systems of regional level, such as technogenic industrial systems (TIS) are also SEEH type systems.

To investigate and solve these problems, management and decision-making methods and models based on the object-oriented approach have been traditionally used. However, a series of scientific publications and scientific schools have recently appeared, which lay emphasis on the importance and necessity of recording the behavior dynamics of a management subject, use of the subject-oriented approach and reflection to resolve the said tasks [1-5].

The paper proposes the review and analysis of some findings obtained in the recent years by different authors for macro- and micro-modeling of the dynamics of eco-economic and socio-humanitarian systems and processes which are attributed to TOP and function and develop under the complex conditions of non-linearity, instability and crises.

Most of the previously created models of socio-eco-economic systems (SEES) have theoretical and deterministic nature and are rather problematic from the viewpoint of

the adequacy and availability of information for their implementation. In this connection, the objective of technogenic regional production operations (TRO) management under the conditions of crisis causes the objective necessity of improving methods, models and information technologies on the basis of stochastic equations for SEEH management.

The key requirement of the sustainable development paradigm includes creation of existence conditions for future generations by means of restricted use of natural resources, establishment of natural resources and environment recovery cycles together with social capital development – all these can only be realized based on the use of scientific and technical achievements on the back of the high innovation activity. Therefore, the innovative development paradigm conceptually justifies the way for achievement of sustainable growth of TRO (TOP) with the help of development of the human potential and reduction of the TRO load on people and the environment.

To improve the TRO management efficiency amid crisis, one should positively influence all its structural components on which the success of the long-term TRO activities depends. Sustainable development of the TRO requires such choice and combination of its component parts to ensure harmonious functioning of the TRO as a whole. One of the main drivers of increasing the operating efficiency of the TRO includes intensification of production, which is crucially influenced by science. Intellectual capital of the TRO is an internal resource capable of giving new innovative advantages to it. It is important that the innovation activities of the TRO aimed at getting over crisis events result in the increased level of their systematicity, and a synergetic effect was obtained owing to this.

The papers [1-5] studied the process of improvement of the technogenic regional production operations management mechanism through development of methods, models and information technologies of socio-eco-economic management (SEEM) amid crisis. The mathematical and conceptual models were proposed, and scenario calculations were carried out for the TRO management simulation model.

This research represents the development of the findings of the authors' papers [1-5] for eco-economic modeling and management in case of recording of stochastic impact factors, and we hope that the presented material will be useful for both prominent researchers in this area of science and young scientists.

3 Main Results

The conceptual model of forecasting and management of eco-economic processes (EEP) of a technogenic economic object (TEO) under the conditions of “NO and MANY factors” available, can be presented in the form of a set-theoretical model as a tuple [3, 5]:

$$\langle X, Y, F, H, R, E, \Omega, T, G, K_u, K_p, P, U \rangle, \quad (1)$$

where X – set of possible states of the technogenic economic object; $Y = \langle Y^{ekn}, Y^{ekl} \rangle$ – total output of the technogenic economic object, where Y^{ekn} – productive set (i.e. “useful output”), and Y^{ekl} – set of pollutions (i.e. “harmful output”); $F = \langle F^{ekn}, F^{ekl} \rangle$ – model

reflection of the TEO; $H = \langle H^{ekn}, H^{ekl} \rangle$ – general operator of observations (measurements); R – resource set (i.e. main controlled entry of the TEO); E – set of unidentified factors (both external and internal, i.e. both additive and multiplicative), in particular this is a set of stochastic, fuzzy, multiple or mixed uncertainty; Ω – set of constraints; $T = [t_0, t_k]$ – time interval of the TEO functioning and development; G – target set; K_u – generalized eco-economic control criterion (EECC); K_p – generalized forecasting optimization criterion (FOC); P – eco-economic forecasting operator; $U = \langle U^{ekn}, U^{ekl} \rangle$ – eco-economic control (EEC) vector. Designations “ ekn ” and “ ekl ” correspond to economic and environmental variables.

Then the task of optimal eco-economic forecasting, i.e. determining a predictor for both internal and external processes can be formulated as follows: determine the estimate $\hat{x}(t_k T + \Delta), \Delta = \Delta_0, \Delta_1, \dots$ of the state vector $x(t_k + \Delta)$ with the preset forecast step Δ on the basis of multiple eco-economic observations $\{y(t), t \in [t_0, t_k]\}$ and based on the preset FOC K_p .

Now the EEC task is to determine the effective integral management vector $U = \langle U^{ekn}, U^{ekl} \rangle$ on the bases of the estimates $\hat{x}(t_k T + \Delta), \Delta = \Delta_0, \Delta_1, \dots$ and non-linear dynamic eco-economic model of the TEO that ensures achievement of the goal G with a preset generalized eco-economic criterion K_u and constraints Ω taking into account the uncertainty and risks.

The multiplicative-additive stochastic model with the chaotic dynamics can be generally presented as vector equations:

$$\begin{aligned} \dot{x} &= A(t)x(t)[X^0 - x(t)] + D(t), \\ A(t) &= a(t)\lambda(t)\zeta(t), \quad D(t) = d(t)\xi(t) \end{aligned} \quad (2)$$

or, multiplicative-additive stochastic model with the chaotic dynamics and with management, i.e. taking into account action managers:

$$\begin{aligned} \dot{x} &= A(t)x(t)[X^0 - x(t)] + D(t) + P(t), \\ A(t) &= a(t)\lambda(t)\zeta(t), \quad D(t) = d(t)\xi(t), \quad P(t) = p(t)\psi(t)u(t). \end{aligned} \quad (3)$$

The observation model is represented as follows:

$$y(t) = H(t)x(t) + \eta(t). \quad (4)$$

Here, the following designations are used: $\zeta(t), \xi(t), \eta(t)$ – multiplicative-additive stochastic components in the models (2)-(4), and $\lambda(t)$ – chaotic component in the system model (2). Other designations are shown below.

The integral socio-eco-economic dynamic behavioral model with spiritual and moral variables can be conceptually presented in a general (block) form [4, 5]:

$$\begin{cases} \dot{X}_1 = f_1(X_1, X_2, X_3, X_4; P_1, \xi_1), \\ \dot{X}_2 = f_2(X_1, X_2, X_3, X_4; P_2, \xi_2), \\ \dot{X}_3 = f_3(X_1, X_2, X_3, X_4; P_3, \xi_3), \\ \dot{X}_4 = f_4(X_1, X_2, X_3, X_4; P_4, \xi_4), \end{cases} \quad (5)$$

where $X=(X_1, X_2, X_3, X_4)$ – combined vector of behavioral variables and states of the socio-eco-economic system taking into account the humanitarian level variable (SEEH) – X_4 , as well as in (5) $X_1=X_1(t)$ – vector of economic variables; $X_2=X_2(t)$ – vector of environmental variables (pollution variables); $X_3=X_3(t)$ – vector of social variables; $P=(P_1, P_2, P_3, P_4)$ – cumulative vector of SEES parameters (intra-system and environmental); $\Xi=(\xi_1, \xi_2, \xi_3, \xi_4)$ – vector of external random and unidentified variables. For example, for technogenic production systems (TPS) [3] $X_1=(K_1, L_1, I, \tau, C)$, $C=(C_1, C_2, C_3, C_4)$ – vector of some consumption (expenditure) parameters, and C_1 – value of social consumption (i.e. for wages, etc.); $C_2=C_e$ – consumption for the environment; $C_3=C_s$ – consumption for safety and security; $C_4=C_i$ – investment volume for innovation, information and humanitarian technologies.

Synergetic dynamics model of the non-linear stochastic system with the chaotic behavior:

$$\begin{aligned} \dot{x}_i &= \lambda_i \xi_i(t) x_i(t) \left[\Sigma_X \pm \sum_{j=1}^n a_{ij}(t) \prod_{k=1}^j x_k(t) \right] + \sum_{l=1}^3 d_{il} \frac{\partial^2 x_i}{\partial r_l^2} + w_i + b_l u_i(t), \\ i &= \overline{1, n}, \quad \overline{x_i(0)} = x_{i0}, \end{aligned} \quad (6)$$

where $\langle \xi_i, w_i \rangle$ – stochastic components of the model; $\{a_{ij}(t)\}$ – non-stationary components of the model; $\{d_{il}\}$ – diffusion coefficients determining the level of distribution of the state variables; Σ_X – aggregate maximum (maximum allowable) value of the vector x , $\{\lambda_i\}$ – set of parameters causing chaotic nature.

In particular, this model can be also represented as an equation system:

$$\dot{X}_i / \partial t = A_i [\xi_i (r_i X_i - \sum_{j \neq i} b_{ij} X_i X_j - a_i X_i^2) + D_i(x, y) \Delta X_i] + \varsigma_i + u_i, \quad (7)$$

where X_i – coordinates of the system state vector, where $X_i \equiv X_i(t, x, y)$; $i, j = 1, 2, \dots, n$ – reproduction (duplication, growth, development, etc.) coefficient; a_i – saturation parameter limiting growth (reproduction); b_{ij} – subsystem interaction parameter (between business entities); $D_i(x, y)$ – diffusion factor of the i -th subsystem (of the economic entity) in the point (x, y) ; $\xi_i \equiv \xi_i(t, x, y)$ and $\zeta_i \equiv \zeta_i(t, x, y)$ – stochastic multiplicative and additive components of the model, respectively; $u_i \equiv u_i(t, x, y)$ – coordinates of the management vector, i.e. vector of managerial decisions; A_i – scaling factor; ∇ – Laplacian, i.e. $\nabla(*) = \partial^2(*)/\partial x^2 + \partial^2(*)/\partial y^2$ and $t \in [0, T]$ – time interval of the system functioning and development.

Such models describe and cover rather wide class of complex processes and systems, including the noospheric model of stable development (NMSD) [5].

The system has synergetic (or cybernetic) description, if the effectively built operator D is such that the state of the system at each point of time $t \in (t_0, T(t_0))$ can be built based on the vector values $x(\tau)$, $\tau \in (t_1, t_0)$, provided that all the external managing actions are fixed:

$$x(t)=D(x(\tau), \varepsilon, \eta, u), t \in (t_0, T(t_0)), \tau \in (t_1, t_0), \quad (8)$$

where $\varepsilon(t, r)$ – random action with the known probabilistic characteristics; $\eta(t, r) \in G_\eta$ – action predetermined by the extent of uncertainty; $G_\eta, u \in R^k$ – managing actions; r – spatial variable (vector).

Consequently, the integrated stochastic model of the growth dynamics for forecasting the development of the innovative economy can be represented in the form of the following system of difference equations:

$$K_{t+\Delta} = K_t - (\alpha K_t - I_t + C_t + D_t + B_t)\Delta + \sigma_K \Delta \xi_t, \quad (9)$$

$$Y_t = F(K_t, L_t, R_t, \xi_t) = \left[\beta_1 K_t^{\frac{\delta-1}{\delta}} + \beta_2 L_t^{\frac{\delta-1}{\delta}} + \beta_3 R_t^{\frac{\delta-1}{\delta}} \right]^{\frac{\delta}{\delta-1}} + \sigma_Y \xi_t, \quad (10)$$

or

$$Y_t = A\mathcal{T}_t \left[(1 - \alpha_K^1(t) - \alpha_K^2(t) - \alpha_K^3(t))K_t \right]^{\alpha_1} \cdot \left[(1 - \alpha_{L_2}^1(t) - \alpha_{L_2}^2(t))L_{2t} \right]^{\alpha_2} + \sigma_Y \xi_t, \quad (10^*)$$

$$L_{t+\Delta} = L_t + (\gamma L_t - \gamma_Z Z_t + \gamma_C C_t)\Delta + \sigma_L \Delta \xi_t, \quad L(0) = L_0, \quad (11)$$

$$R_{t+\Delta} = R_t + (\gamma_R R_t + \gamma_K K_t - Y_t - \gamma_L L_t)\Delta + \sigma_R \Delta \xi_t, \quad R(0) = R_0 \quad (12)$$

or

$$R_{t+\Delta} = R_t + (d(K_t, L_t, R_t) + \gamma_K K_t - \gamma_L L_t - Y_t)\Delta + \sigma_R \Delta \xi_t, \quad (12^*)$$

$$Z_{t+\Delta} = Z_t + (g(Z_t) + f^*(C_t, K_t, L_t, R_t)(1 - \eta C_t))\Delta + \sigma_Z \Delta \xi_t, \quad Z(0) = Z_0, \quad (13)$$

$$z_{t+\Delta} = z_t + (\delta_z z_t + E[\varphi_t]^{v_1} \cdot [\alpha_L^1(t)L_t]^{v_2} \cdot [\alpha_K^2(t)K_t]^{v_3})\Delta + \sigma_z \Delta \xi_t, \quad (13^*)$$

$$\varphi_{t+\Delta} = \varphi_t + (\delta_\varphi \varphi_t + G[\varphi_t]^{y_1} \cdot [\alpha_{L_1}^1(t)L_t]^{y_2} \cdot [\alpha_K^1(t)K_t]^{y_3} \cdot [s(t)]^{y_4})\Delta + \sigma_\varphi \Delta \xi_t, \quad (14)$$

$$L_{1t+\Delta} = L_{1t} + (\delta_{L_1} L_{1t} + D[\varphi_t]^{n_1} \cdot [\alpha_{L_1}^2(t)L_{1t}]^{n_2})\Delta + \sigma_{L_1} \Delta \xi_t, \quad (15)$$

$$s_{t+\Delta} = s_t + (\delta_s s_t + H[\varphi_t]^{v_1} \cdot [\varepsilon_L^1(t)L_t]^{v_2} \cdot [\varepsilon_K^2(t)K_t]^{v_3} \cdot [\varepsilon_z^3(t)z_t]^{v_4})\Delta + \sigma_s \Delta \xi_t, \quad (16)$$

$$\tau_{t+\Delta} = \tau_t + \{\delta_\tau \tau_t + Q \left[\frac{\varphi_{t+\Delta} - \varphi_t}{\Delta} + \delta_\varphi \varphi_t \right]^{\beta_1} \cdot \left[\frac{L_{t+\Delta} - L_t}{\Delta} + \delta_{L_t} L_t \right]^{\beta_2} \cdot \left[\frac{s_{t+\Delta} - s_t}{\Delta} + \delta_s s_t \right]^{\beta_3} \cdot \left[\frac{z_{t+\Delta} - z_t}{\Delta} + \delta_z z_t \right]^{\beta_4} \} \Delta + \sigma_\tau \Delta \xi_t, \quad (17)$$

$$K_{t+\Delta} = K_t - (\alpha K(t) + I_{ht} - C_t - D_t - B_t) \Delta + \sigma_K \Delta \xi_t, \quad K(0) = K_0, \quad (18)$$

$$I_{ht+\Delta} = I_{ht} - (rI_h(t) + h_0 I_0) \Delta + \sigma_{I_h} \Delta \xi_t, \quad I_h(t_0) = h_0 I(t_0), \quad (19)$$

$$C_{t+\Delta} = C_t + \{A_t K_t - (1 + \delta) K_t\} \Delta + A_t K_t \sigma_C \Delta \xi_t, \quad (20)$$

where Δ – step of the time interval (forecast step), for which calculations will be made; ξ_t – realization of the random value which is subject to the standard normal law with the average equal to zero and dispersion equal to one. Also note that here $z(t)$, $s(t)$, $\tau(t)$, $\varphi(t)$ are the indexes of the respective basic indicators.

Note that computer realization of the stochastic difference (discrete) equations (9) – (20) will require transition to the averaged variables $x(t) = (Y(t), K(t), L(t), R(t), Z(t), z(t), s(t), \tau(t), \varphi(t), I_h(t), C(t))$, i.e. to their expectation values.

Optimal control / management criteria options. Eco-economic development strategy selection criterion:

$$M[\Phi(C, Y, D, B)] \rightarrow \max, \quad (21)$$

where $\Phi(C, Y, D, B)$ – welfare function, and M – expectation value symbol.

Consequently, the hierarchical optimization model of the system is obtained in the following form:

$$\begin{cases} M\{Z\} \rightarrow \min, M\{K\} \rightarrow \max, \\ \dot{Z} = \chi(Z, K, L, R, c), \dot{K} = \varphi(K, L, R, c). \end{cases} \quad (22)$$

In case of a “small” integral management model, utility function (UF) is a function of the parameters / variables $\tilde{u}(\alpha_1, \alpha_2, \alpha_3, \alpha_4)$, where $\{\alpha_k(t), k=1, \dots, 4\}$ – shares of costs for non-manufacturing, environmental costs, R&D efforts, for safety and security, innovation and information technologies, etc., and then the following relationship will be the optimality criterion:

$$\Lambda(c, k, z, L, \tau, S) = \int_{t_0}^T \tilde{u}(\alpha_1, \alpha_2, \alpha_3, \alpha_4) \exp(-\theta t) dt \rightarrow \max_{\{\alpha_i\} \in \Omega}.$$

To resolve the EEC tasks on the basis of the presented stochastic and deterministic models, one can use the known classical methods of optimal control with restrictions [3].

Generally, the optimization criterion can be represented as

$$\Lambda(\bar{a}) = \int_{t_0}^T \tilde{u}(\alpha_1, \alpha_2, \alpha_3, \alpha_4, \dots) \exp(-\theta t) dt \rightarrow \max_{\{\alpha_i\} \in \Omega}.$$

This requires even higher integration of models and criteria (and restrictions) of management optimization and DP.

It is also important to consider criteria of random (stochastic) factors of multiplicative and adaptive impact in the models.

In other words,

$$\Lambda(\bar{a}) = M \left[\int_{t_0}^T \tilde{u}(\alpha_1, \alpha_2, \alpha_3, \alpha_4, \dots) \exp(-\theta t) dt \right] \rightarrow \max_{\{\alpha_i\} \in \Omega}. \quad (23)$$

As a criterion in tasks similar to the one in question, objective functional of maximization of the average per capita consumption of employee within the temporary interval is usually assumed $[0, T]$:

$$\int_0^T \frac{C(t)}{L_1(t) + L_2(t)} \exp(-\theta t) dt \rightarrow \max \quad (24)$$

where $\theta > 0$ – discount factor that reflects the extent of giving preference to the future consumption over the current one.

Note that the criterion (24) is only a private (economic) criterion. Therefore, socio-ecological, innovation and other optimality criteria are also required integrally!

Control synthesis task in stochastic systems. Let us consider the optimal management synthesis task in stochastic linear systems [6].

Phase state of the system means the vector $x = (x_1, x_2, \dots, x_n)$, where $x_i, i=1, \dots, n$ – aggregate of data describing the i -th sector of the system. Let us assume that all the sectors are provided with some management levers: $u = (u_1, u_2, \dots, u_n)$.

Each of the listed parameters, in its turn, represents a vector composed of the numeric values of different characteristics of the system dynamics. Let us assume that $[t_0, t_k]$ – reviewed system development period. Let us designate as ζ the vector of some additional parameters determined by means of forecasting using statistical data of the system, or which are constants.

Consequently, the dependence is studied of each variable $x_i, i=1, \dots, n$ from the managing variables u_i of the system states and the vector of parameters ζ .

The linearized system model looks as follows:

$$\begin{aligned} \dot{x}(\zeta, t) &= A(\zeta)x(\zeta, t) + B(\zeta)u(\zeta, t), \\ x(\zeta, t) &\in R^n, u(\zeta, t) \in R^m, \\ A(\zeta) &\in R^{n \times n}, B(\zeta) \in R^{n \times m}; \end{aligned} \quad (25)$$

where $A(\zeta) = |A_{ij}(\zeta)|, B(\zeta) = |B_{ij}(\zeta)|$ – matrices with parametric uncertainty; $x(\zeta, t) = [x_i(\zeta, t)]$ – system state vector; $u(\zeta, t) = [u_i(\zeta, t)]$ – management vector; ζ – vector of stochastic processes.

The task of optimal management synthesis for a stochastic dynamic system is posed as follows: to find an optimal management law in the form of [6]:

$$u(\xi, t) = -L\hat{x}(\xi, t), \quad (26)$$

and the objective functional for optimization (minimization) should be predetermined in the following form:

$$J = \int_{\Omega} \left\{ \int_0^{t_k} (x^T(\xi, t)\Theta x(\xi, t) + u^T(\xi, t)Ru(\xi, t)) dt \right\} \rho(\xi) d\xi.$$

In a simple case, linear observation equation may be used in the following form: $y(t) = H(t)x(t) + \eta(t)$. In this equation, the observation $H(t)$ is represented by a stochastic observation matrix, which can be preset in practical terms, and $\eta(t)$ is the “white noise” type process, which can be preset based on statistical data. In doing so, two independent tasks are to be resolved based on the separation principle [6].

In the early papers of the first author of this paper, the task of optimal evaluation (filtration) under the conditions of multiplicative-additive mixtures was resolved using the integral description of the filter [6].

However, the filtration task can also be conveniently resolved using the Kalman filter for the linear case and the Stratonovich filter for the non-linear right part of the dynamics equation [6]. State estimates are found as the conventional average values with the building and solution of the non-linear dispersion equations of the Riccati type. The filter gives a solution for the stochastic differential equation. It can be implemented in the form of the known closed loop system for the distribution density of the initial conditions. The obtained state estimate $\hat{x}(t)$ is used in resolving the other task – optimal management of the type $\hat{u}(t) = -L(t)\hat{x}(t)$. As mentioned above, the optimal management task is usually set on the basis of the Bellman principle or the maximum principle [6]. Different quality functional, as well as the vector of functional may be used as a criterion.

4 Concluding Remarks

Based on the use of state-of-the-art methods, models, information and innovation technologies in order to forecast the state of the non-linear dynamics of eco-economic and socio-humanitarian systems, integrated stochastic models of objects and processes were developed and studied, suitable for the conditions of systemic crises. The paper examines the aspects of integration of multiple business areas and sectors of the modern complex systems of SEEH type functioning and developing under the complex conditions of instability and crises. Complex formalization resulted in obtaining one of the options of the integral socio-eco-economic and innovative non-linear model of dynamics in the form of a system of differential and functional stochastic equations. The paper presents the task of forecasting the state of a complex system in the innovative economy on the basis of the integral model in a phased space with

observation equations, development of optimal management filters and algorithms. The prospects of the further investigations include conducting computer experiments.

The paper deals with the problem of sustainable development and innovative integral modeling approach in the management of technogenic objects and processes as a system of socio-eco-economic and humanitarian type. Based on the use of information and innovation technologies in order to forecast the non-linear dynamics of eco-economic and socio-humanitarian systems, integrated stochastic models of objects and processes were developed and studied, suitable for the conditions of systemic crises. The paper handles the aspect of integration of 4 business and functioning areas of the modern complex systems. It proposes a general conceptual integrated model, generalized synergetic model of dynamics, considering different uncertainty (stochastic and chaotic components). Most of the previously created dynamics models of eco-economic and socio-humanitarian systems and processes functioning and developing under the complex conditions of non-linearity, instability and crises, have theoretical and deterministic nature and are rather problematic from the viewpoint of the availability of information and adequacy for their implementation. In this connection, the objective of TOP management conditions the objective necessity of improving methods, models and information technologies on the basis of stochastic equations for SEEH management.

Integral socio-eco-economic stochastic models of the dynamics of TOP systems, i.e. technogenic integrated systems functioning under the conditions of the current systemic crises, were developed and investigated.

Based on the use of state-of-the-art methods, models, information and innovation technologies in order to forecast the state of the non-linear dynamics of eco-economic and socio-humanitarian systems, integrated stochastic models of objects and processes were developed and studied, suitable for the conditions of systemic crises. The paper approaches the aspect of integration of multiple business areas and sectors of the modern complex systems of SEEH type functioning and developing under the complex conditions of instability and crises. Complex formalization resulted in obtaining one of the options of the integral socio-eco-economic and innovative non-linear model of dynamics in the form of a system of differential and functional stochastic equations.

An integrated stochastic non-linear growth dynamics model was developed and studied to forecast the development of the state of an innovative economy, which is suitable for the conditions of risks and crises. The paper examines the aspects of integration of multiple business areas and sectors of the modern complex systems functioning and developing under the present conditions of instability. The prospects for the further investigations include representation of the proposed integral model in a phased space with observation equations, development of optimal management filters and algorithms.

The prospects of the further investigations in this area include conducting computer experiments and their wide practical use. The prospects also include development and investigation of models, criteria and methods of optimal management of technogenic objects and creation of decision-making systems based on the proposed integral model within the state space.

References

1. Ramazanov, S.K., Sergienko, A.V.: Integral socio-ecological and economic stochastic model of dynamics of technogenic regional enterprise in the conditions of crisis. In: Solovyov, V.N. (ed.), pp. 89–108. Cherkasy (2015)
2. Ramazanov, S.K., Rogoza N.E., Musayeva E.K.: Nonlinear models and analysis of complex systems: on-tutorial manual. In: Ramazanov, S.K. (ed). Luhansk-Poltava (2009)
3. Ramazanov, S.K.: Tools of ecological and economic management of the enterprise. Donetsk (2008)
4. Ramazanov, S.K.: Modeling of social-ecological-economic dynamics in an unstable environment. In: Information Sciences and Systems Science (ISN-2015), pp. 284–287. Poltava (2015)
5. Ramazanov, S.K., Burbelo, O.A., Vitlinsky, V.V. et al.: Risks, security, crises and sustainable development in the economy: methodologies, models, methods of management and decision-making. In: Ramazanov, S.K. (ed). Luhansk (2012)
6. Ostrem, K.: Introduction to the stochastic theory of control. Moscow (1970)
7. Grigorkiv, V.S.: Simulation of a Multisectoral Ecological-Economic System. Vol. 3, pp. 147–157. (1999)
8. Solovyov, V.I.: Economic-mathematical modeling of the software market. Moscow (2009)
9. Geets, V.M., Seminozhenko, V.P.: Innovative Prospects of Ukraine. Kharkiv (2006)
10. Klebanova, T.S., Kizim, N.A.: Models of estimation, analysis and forecasting of socio-economic systems: monograph. Kharkiv (2010)
11. Lyashenko, I.M., Korobova, M.V.: Fundamentals of mathematical modeling of economic, ecological and social processes: taught. Ternopil (2006)
12. Ayvazyan, S.A., Afanasev, M.Yu., Rudenko, V.A.: Some questions of the specification of three-factor models of the company's production potential, taking into account intellectual capital. Vol. 3(27), pp. 78-87 (2012)
13. Kleiner, G.B.: System Economics and System-Oriented Modeling. Vol. 3, pp. 71–93 (2013)
14. Leont'ev, V., Ford, D.: Inter-industry analysis of the impact of the structure of the economy on the environment. Vol. 8, No. 3, pp. 370-400 (1972)
15. Tsukui, J., Murakami, Y.: Turnpike's Optimality in the input-output system-theory and application for planning. Amsterdam (1979)
16. Brock, W.A., Hsieh, D.: Nonlinear Dynamics, Chaos and Instability (1991)
17. Tahvonen, O., Kuuluvainen, J.: Economic growth, pollution, and renewable resources. *J. Env. Econ. M.* 24, 78–88 (1993)
18. Vagapova, Ya.Ya.: Modeling of economic growth taking into account ecological and social factors. Moscow (2007)
19. Moiseyev, A.N.: Optimal and balanced trajectories in models of economic growth with an endogenous form of NTP, pp. 178–190 (2004)
20. Makarov, V.L.: Computable Model of the Knowledge Economy. Vol. 45, 1, pp. 70–82 (2009)
21. Moiseev, N.N.: Mathematical problems of system analysis. Moscow (1981)
22. Kolemaev, V.A.: Economic-mathematical modeling. Modeling of macroeconomic processes and systems. Moscow (2005)
23. Krass, M.S., Chuprinov, B.P.: Mathematical methods and models for masters of economics. Saint Petersburg (2006)
24. Vorontsovsky, A.V., Vyunenko, L.E.: Forecasting the development of the economy on the basis of a hundred-hasty model of economic growth, taking into account the turning point. Vol. 5, 4, pp. 4–32. Saint Petersburg (2016)

25. Solou, R.: Theory of Growth. Panorama of the Economic Thought of the End of the 20th Century. In: Greenway, D., Blini, M., Stewart, I. (eds.). Vol. 1, pp. 479–506 (2002)
26. Ramazanov, S., Chernyak, O., Tishkov, B., Ahmedov, R., Honcharenko, O.: Non-linear forecasting of the state of a socio-eco-oriented innovative economy in the conditions of systemic crises. SHS Web of Conferences. **65**, 06007 (2019). doi:10.1051/shsconf/20196506007

Analysis of Regional Development Disparities in Ukraine Using Fuzzy Clustering

Kateryna Gorbatiuk^[0000-0003-1477-4085], Olha Mantalyuk^[0000-0002-0162-4312],
Oksana Proskurovych and Oleksandr Valkov

Khmelnytskyi National University, 11, Instytutka Str., Khmelnytskyi, 29000, Ukraine
kt_datsyuk@ukr.net, olyasikol@gmail.com,
pov1508@gmail.com, pulolalala@ukr.net

Abstract. Disparities in the development of regions in any country affect the entire national economy. Detecting the disparities can help formulate the proper economic policies for each region by taking action against the factors that slow down the economic growth. This study was conducted with the aim of applying clustering methods to analyse regional disparities based on the economic development indicators of the regions of Ukraine. There were considered fuzzy clustering methods, which generalize partition clustering methods by allowing objects to be partially classified into more than one cluster. Fuzzy clustering technique was applied using R packages to the data sets with the statistic indicators concerned to the economic activities in all administrative regions of Ukraine in 2017. Sets of development indicators for different sectors of economic activity, such as industry, agriculture, construction and services, were reviewed and analysed. The study showed that the regional cluster classification results strongly depend on the input development indicators and the clustering technique used for this purpose. Consideration of different partitions into fuzzy clusters opens up new opportunities in developing recommendations on how to differentiate economic policies in order to achieve maximum growth for the regions and the entire country.

Keywords: regional development disparities, clustering methods, hierarchical cluster technique, fuzzy clustering technique, fuzzy clusters, fuzzy c-means algorithm.

1 Introduction

Economic policies that take into account differences in regional development should be coordinated using scientific approaches to achieve maximum results in each region and for the whole country. This article is dedicated to the problem of clustering Ukrainian regions in different groups accordingly to their economic development levels. The usefulness of such division is obvious. Really, having at disposal the partitioning into different clusters based on economic indicators, a decision maker can elaborate economic policy measures, which are specific for every cluster and similar for all the regions inside the same cluster. So, the number of policy options substantially

reduce in comparison with the case, when the decision is made on each particular region.

Clustering also provides an opportunity to identify groups of regions that are most attractive as objects of domestic and foreign investment. Undoubtedly, the use of cluster analysis for improving regional policy will increase the efficiency of the economic system as a whole, which is especially important for today's Ukraine and is a necessary condition for its economic growth.

Nowadays, a good deal of research representing manifold of cluster analysis approaches and tools has been conducted and reflected at the relevant literary sources. Nevertheless, search for the most acceptable clustering methods still retains its relevance. The reason is that every method has its own advantages and disadvantages.

Fuzzy clustering methods permit the gradual assessment of the membership of data elements in a cluster which is described by a membership function valued in the real unit interval $[0; 1]$. So, in fuzzy clustering it is assumed that the boundaries between groups are not well defined, like in the case of most natural systems. Therefore, fuzzy clustering approaches make it possible to more adequately describe and solve the real problem, such as estimating regional development disparities.

This article presents a study on application of hard cluster analysis methods and clustering methods based on fuzzy sets theory. A new approach to evaluating regional disparities in Ukraine using a fuzzy clustering technique is given. There were used statistical data on indicators of economic activities in different regions of Ukraine in 2017. The considered methods are especially useful for the case of qualitative economic indicators.

This article consists of six sections. The first one substantiates the background of the conducted research. In the second section, review of the scientific literature on research topic is presented. The third part reveals the theoretical basis of the proposed clustering techniques. The course of the study and its main results are presented in the fourth and fifth parts of this paper. The final part contains conclusions based on the research results and discussing areas for the further studies in the field of exploring fuzzy clustering methods and adapting them to regional clustering tasks.

2 Literature Review

Regional disparities are closely connected to unequal economic development of the regions in different sectors. So, economic disparities are associated with differences in regional qualitative and quantitative economic indicators. Economic disparities are generally assessed using such indicator as gross national product (GNP), combined with the analysis of tax revenues, the growth of industry and agriculture, demographic trend, infrastructure and services [1].

Studies on estimating and classifying of regional development disparities have been performed by many researchers [1-9] all over the world. The most common approaches, which are used for this purpose, are econometric modeling [4, 8, 9], Klassen typology theory [1-3] and different clustering techniques [1, 2, 6]. At the same time, among

clustering methods, k-means clustering and hierarchical clustering are most widely used.

The Klassen typology and the developed fuzzy-Klassen model are discussed in the paper [3] along with giving the recommendations on their use in modeling regional development disparities.

The use of clustering techniques in the tasks of classification of regions by the level of economic indicators is represented in articles [1, 2, 6]. Also, there were proposed to join the traditional clustering approaches with fuzzy methods, based on fuzzy sets theory of L. Zadeh [10], and a lot of researches were done to apply them in practice.

The theoretical basics on clustering methods, fuzzy clustering algorithms and their program software implementations are considered in numerous works [11-30]. In this study, we used the fuzzy clustering approaches to identify disparities in the development of Ukrainian regions, which allow us to explore and utilize the advantages of this technique.

3 Research Methodology

Clustering is one of the important data mining techniques that enable the discovery of hidden relationships from data [15]. The goal of the clustering is to divide the set of data items into several number of groups c , called clusters. The result of any cluster algorithm is the mapping of data items to a specific group.

In general, clustering techniques are divided into two types, Hierarchical and Partitioned clustering [22]. Partition clustering algorithms divide the data sets into clusters assigning dissimilar data objects to different clusters.

Hierarchical cluster techniques are generally classified into two types, which are agglomerative and divisive clustering [22]. These cluster methods form a dendrogram, which represents nested grouping pattern and similarity level in classification process. At certain group level, dendrogram will break into another group level, thus producing a different data group. In hierarchical clustering, objects that belong to a child cluster also belong to the parent cluster [13].

Hierarchical cluster methods classify data by similarity of distance between two data points. The classical methods for distance measures are Euclidean and Manhattan distances, which are defined as follow [19]:

$$d_{euc}(x, y) = \sqrt{\sum_{i=1}^n (x_i - y_i)^2}, \quad (1)$$

$$d_{man}(x, y) = \sum_{i=1}^n |x_i - y_i|, \quad (2)$$

where x and y – two vectors of length n ; $d_{euc}(x, y)$ – Euclidean distance; $d_{man}(x, y)$ – Manhattan distance.

Also, there are many other methods to calculate the distance information, but the right choice of distance measures, which depends on the type of the data and the

researcher questions, is very important, as it has a strong influence on the clustering results [19].

The conventional (hard or hard) clustering methods restrict that each point of the data set belongs to exactly one cluster [14]. Fuzzy set theory proposed by Zadeh [10] in 1965 gave an idea to describe the uncertainty of belonging to particular class by a membership function. Applications of fuzzy set theory in cluster analysis were early proposed in the work of Bellman, Kalaba, Zadeh [23] and Ruspini [17].

Basic fuzzy clustering techniques include: fuzzy clustering based on fuzzy relation, fuzzy clustering based on objective functions, and the fuzzy generalized K-nearest neighbour rule – one of the powerful nonparametric classifiers [14].

For all fuzzy clustering algorithms, it is necessary to pre- assume the number c of clusters because, in general, the number c should be unknown [14]. The quality of the classification of data into partitions depends on the value of the parameter c that is provided to the algorithm [15].

Fuzzy clustering is a soft clustering technique for classifying data into groups. In fuzzy clustering each data point belongs to all the clusters with varying memberships and these membership values range between zero and one [15].

Most of the clustering algorithms follow a similar structure [11]: (1) select initial cluster centers, (2) calculate the distances between all points and all cluster centers, (3) update the partition matrix until some termination threshold is met. In particular, the classification of fuzzy algorithms is represented in [11].

The most well-known fuzzy clustering algorithms are: fuzzy c-means, fuzzy k-means, (ISODATA), Gustafson Kessel (GK) algorithm [13] etc.

The fuzzy c-means (FCM) algorithm involves the processes in which there is calculation of cluster centers and assignment of points to these centers using a formula of Euclidian distance [13]. The fuzzy c-means algorithm is one of the most widely used fuzzy clustering algorithms. It is a soft clustering algorithm which was firstly studied by Dunn (1973) [28] and generalized by Bezdek (1974; 1981) [29, 30]. The centroid of a cluster is calculated as the mean of all points, weighted by their degree of belonging to the cluster [19]. The above process is kept on repeating itself until the stabilization of cluster centers.

This algorithm assigns a membership value to the data items for the clusters within a range of 0 to 1. Thus, the concepts of fuzzy sets of partial membership are incorporated and forms overlapping clusters for supporting it [13]. Consequently, the data objects closer to the centers of clusters have higher degrees of membership than objects scattered in the borders of clusters [20].

We can apply clustering algorithms using the R software. The following R packages are used for calculations in our research: 1) *cluster*, *ppclust* and *fclust* for computing fuzzy clustering and 2) *factoextra* for visualizing clusters [27].

The function *hclust()* (*cluster* R package) performs a hard hierarchical cluster analysis using a set of dissimilarities for the n objects being clustered. Initially, each object is assigned to its own cluster and then the algorithm proceeds iteratively, at each stage joining the two most similar clusters, continuing until there is just a single cluster. At each stage distances between clusters are recomputed according to the particular clustering method being used [26].

The function *fanny()* (*cluster* R package) can be used to compute fuzzy clustering [26]. It stands for fuzzy analysis clustering and returns an object including the following components: the fuzzy membership matrix containing the degree to which each observation belongs to a given cluster; Dunn's partition coefficient (a low value indicates a very fuzzy clustering, whereas a value close to 1 indicates a near-hard clustering); the clustering vector containing the nearest hard grouping of observations etc. [19].

The function *fcm()* (*pplcust* R package), which applies the fuzzy c-means algorithm also can be used to compute fuzzy clustering. It returns an object including the following components: the fuzzy membership matrix; Initial and final cluster prototypes matrices; the Dunn's Fuzziness Coefficients; the within cluster sum of squares by cluster etc. [19].

4 Case study: Grouping Regions Using Different Clustering Techniques

4.1 Data Set Description

The data for our study was taken from the State Statistics Service of Ukraine [31]. We used the statistic information about the economic activities in 2017 taken by all regions. There we selected some basic indicators of economic activities and we divided them into two groups by their meaning. So, the first group included the indicators of the extraction of aquatic bioresources and the agriculture activities, and the second group included the indicators of the retail trade, services and the industrial activities. All of them were explored and their corresponding values were used in clustering analysis of the regional development. The list of those indicators and their summary statistics are presented in the Tables 1, 2.

Table 1. First group of indicators with their statistics.

Indicator	Mean	Median	St. Dev.	Range
Extraction of aquatic bioresources by fishery water bodies	3793.6	1207.5	5648.1	25163
Value of agricultural products sold by agricultural enterprises	14404.6	14571.7	8143.1	31251
The cost of sold agricultural products from plant growing	11826.2	13293.4	6483.3	20141
The cost of sold agricultural products from animal husbandry	2578.5	2079.9	2672.2	12694
Dynamics of sown areas of agricultural crops, all categories	1158.9	1194.3	520.4	1757.2
Dynamics of sown areas of agricultural crops, agricultural enterprises	811.5	916.1	416.8	1311.5
Dynamics of sown areas of agricultural crops, agricultural households	347.6	307.0	139.3	494.5

In the Table 3, the column "Id" contains the inner identification number of the region which is used for convenience for all following computing results and outputs.

We considered the values of these indicators, gathered in 2017, for all 24 administrative regions in Ukraine (Table 3).

Table 2. Second group of indicators with their statistics.

Indicator	Mean	Median	St. Dev.	Range
Regional structure of turnover of retail trade	27429.9	19576.8	18943.0	66619.1
Completed construction works	3344.9	1932.9	3114.4	10659.9
Volume of industrial products sold	82165.9	43406.2	95282.4	407469.9
Regional structure of retail trade turnover of retail enterprises	18757.8	12174.2	15042.1	52768.5
Used fuel, (10^3)	4075.6	1961.8	5092.7	18645.3
Volume of services sold by enterprises in the service sector, (10^3)	3994.8	2108.6	4053.2	14932.1

Table 3. Administrative regions of Ukraine.

Id	Region	Id	Region
1	Vinnitsya	13	Mykolayiv
2	Volyn	14	Odesa
3	Dnipropetrovsk	15	Poltava
4	Donetsk	16	Rivne
5	Zhytomyr	17	Sumy
6	Zakarpattia	18	Ternopil
7	Zaporizhya	19	Kharkiv
8	Ivano-Frankivsk	20	Kherson
9	Kyiv	21	Khmelnyskiy
10	Kirovohrad	22	Cherkasy
11	Luhansk	23	Chernivtsi
12	Lviv	24	Chernihiv

So, there were built two data sets accordingly to each set of indicators. We denoted them as the First data set and the Second Data set. Then, we used both data sets for clustering the regions, based on different groups of indicators, and compared the results.

4.2 Clustering Results

Before starting the fuzzy clustering analysis, we can apply the hierarchical clustering method, using a linkage method “single”, to both data sets. The results of clustering are illustrated by the cluster dendrograms (Fig. 1, 2), where we can see the data points hierarchically arranged into larger groups dependently on the distances between them.

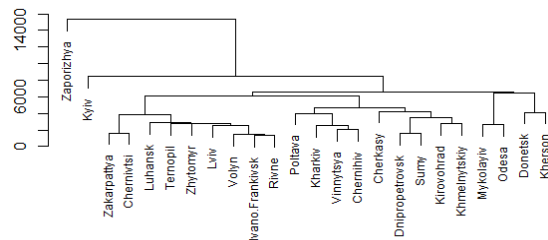
**Fig. 1.** Results of hierarchical clustering for the First data set.

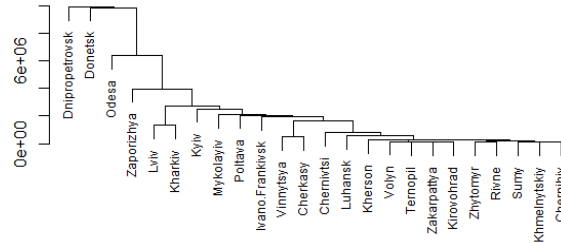

Fig. 2. Results of hierarchical clustering for the Second data set.

4.2.1 Three Clusters.

For the number of clusters equal to three ($c = 3$) we conducted the hierarchical clustering by *hclust()* function [26], using a linkage method “complete”, and obtain the hard clusters for two data sets (Fig. 3-4, Table. 4).

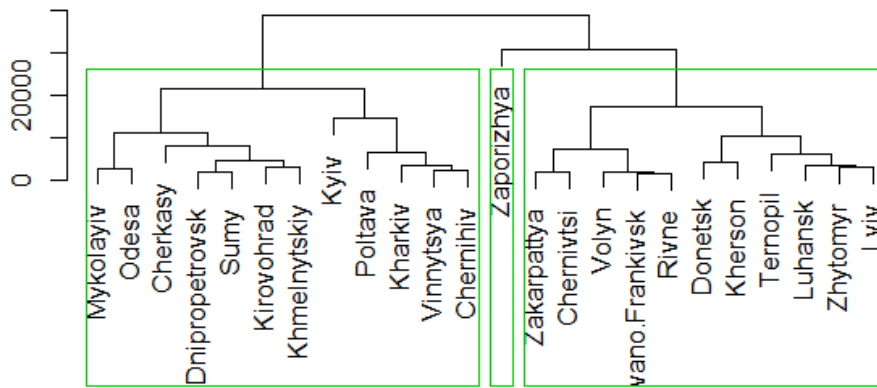

Fig. 3. Three clusters for the First data set.

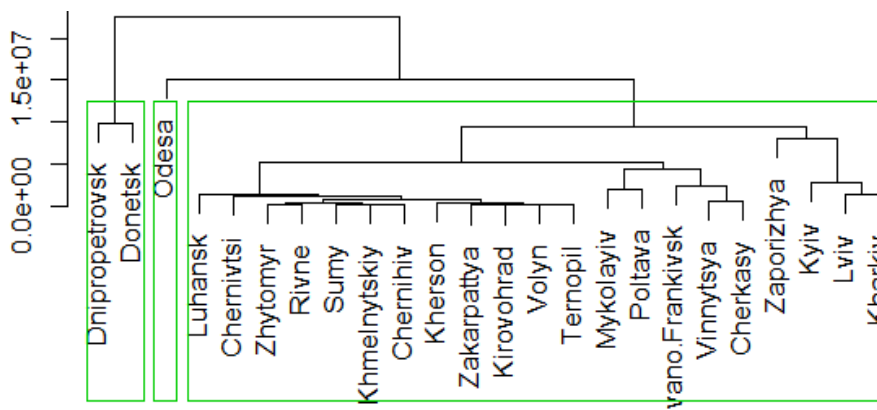

Fig. 4. Three clusters for the Second data set.

Table 4. Hierarchical clustering results for $c = 3$.

Clusters	Regions	
	First data set	Second data set
1	1, 3, 9, 10, 13, 14, 15, 17, 19, 21, 22, 24	3, 4
2	7	14
3	2, 4, 5, 6, 8, 11, 12, 16, 18, 20, 23	1, 2, 5, 6, 7, 8, 9, 10, 11, 12, 13, 15, 16, 17, 18, 19, 20, 21, 22, 23, 24

The fuzzy clustering methods, applied to both data sets, allowed us to obtain the fuzzy clusters which are characterized by membership coefficients indicated the strength of belonging to the particular cluster for all regions.

We illustrated the fuzzy clusters by several charts (Fig. 5-6) and the table with the values of the membership coefficients obtained by the *fcm()* function [19] (Table 5).

Table 5. Membership coefficients for three clusters.

Region	Cluster 1	Cluster 2	Cluster 3
1	0.0069988	0.9614778	0.0315234
2	0.9883655	0.0037207	0.0079138
3	0.0566142	0.3906423	0.5527436
4	0.4711571	0.0926725	0.4361704
5	0.8075004	0.0546427	0.1378569
6	0.8708132	0.0448172	0.0843696
7	0.2282767	0.2399224	0.5318009
8	0.9796605	0.0066517	0.0136878
9	0.0922669	0.6869528	0.2207803
10	0.1287994	0.1990442	0.6721564
11	0.961364	0.0117415	0.0268945
12	0.9448046	0.0166844	0.038511
13	0.0256044	0.0501941	0.9242015
14	0.0454997	0.1413717	0.8131286
15	0.0240021	0.9032314	0.0727665
16	0.9895505	0.003367	0.0070825
17	0.0661397	0.4907331	0.4431272
18	0.5549239	0.1266133	0.3184627
19	0.0109116	0.9509052	0.0381831
20	0.1418759	0.0755601	0.782564
21	0.1426764	0.3478379	0.5094857
22	0.0523409	0.5193732	0.4282859
23	0.9098461	0.0304336	0.0597202
24	0.0167552	0.9196494	0.0635953

The values of membership coefficients vary from 0 to 1 and indicate with different conditional formatting pattern the strength of belonging to the particular cluster for all regions.

The next plot (Fig. 5) shows the overlapping clusters on the set of all data points. It is the scatterplot of the first two principal components which were derived from the data. It also says that, in our case, 85.3% (62.8%+22.5%) of the information about the multivariate data is captured by this plot.

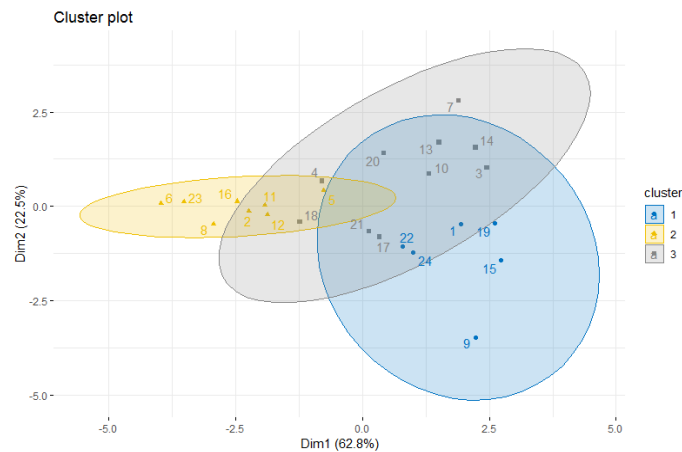

Fig. 5. Plot of three fuzzy clusters for the First data set.

On the following plot (Fig. 5, 6), the data points with the highest values of the membership coefficients are combined into three different clusters to determine which data points more likely are in each cluster.

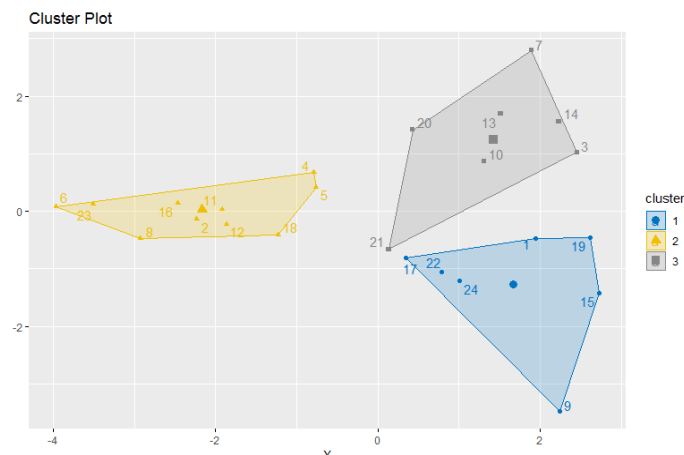

Fig. 6. Plot of three combined clusters for the First data set.

The similar information is shown on the scatterplot (Fig. 7), which says that 85.33 % of the information about the multivariate data is explained by two principal components.

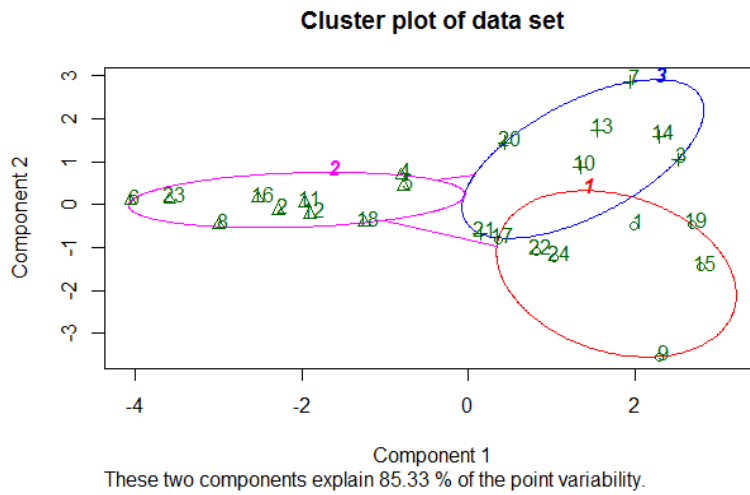

Fig. 7. Plot of the fuzzy clusters for the First data set.

Another fuzzy clustering method *fanny()* [26] gave us a slightly different result (Fig. 8).

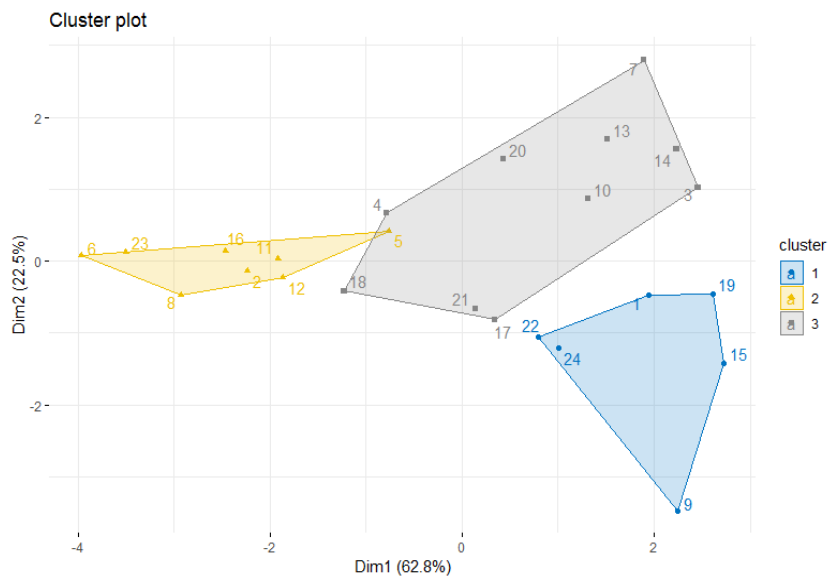

Fig. 8. Plot of three combined clusters by *fanny()* function for the First data set.

To estimate the goodness of the clustering results, we can plot the silhouette coefficients which quantify the quality of clustering achieved. The silhouette plot (Fig. 9) displays a measure of how close each point in one cluster is to points in the neighbouring clusters and allows to determine the optimal number of clusters visually.

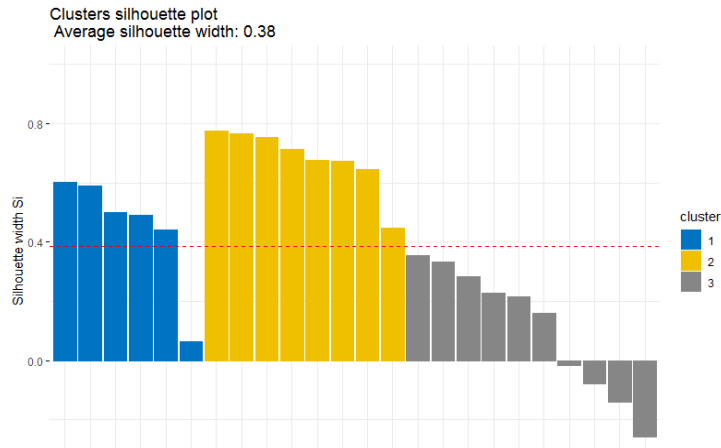

Fig. 9. Plot of the silhouette coefficients for the First data set.

The plot of silhouette coefficients, built by the last clustering results, shows the average level of the silhouette width 0.38. It is not sufficient result and we can see that some data points are not enough close to points in the neighbouring clusters. Especially, the points in the third cluster are very close to the decision boundary between two neighbouring clusters or even might have been assigned to the wrong cluster.

A similar analysis was performed for the Second data set (Fig. 10-11).

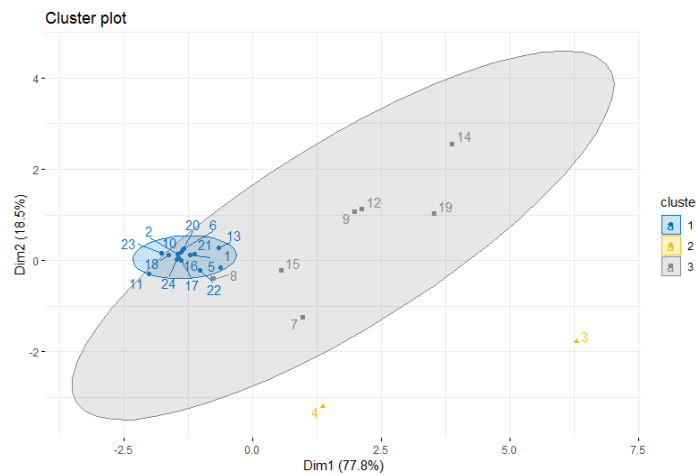

Fig. 10. Plot of the fuzzy clusters for the Second data set.

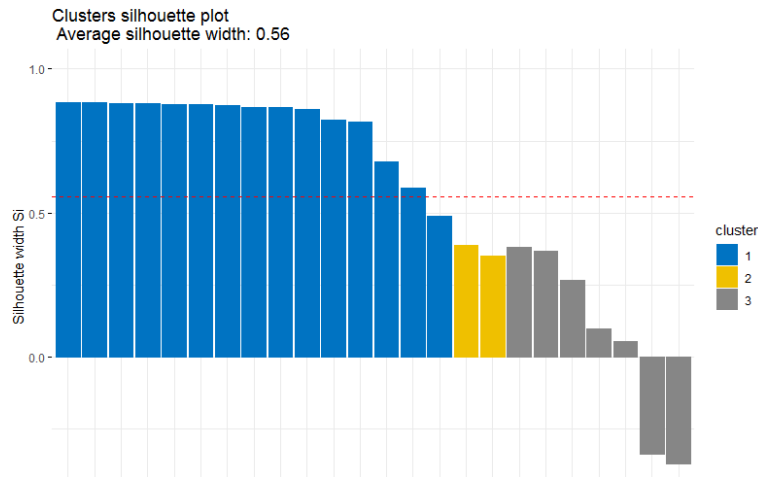

Fig. 11. Plot of the silhouette coefficients for the Second data set.

The scatterplot of two principal components (Fig. 10), which were derived from the data, shows the overlapping clusters on the set of all data points, and also, we can see that around 96.3% (77.8%+18.5%) of the information about the multivariate data is explained by these components.

Then, the data points with the highest values of the membership coefficients combined into three different clusters are presented in the Table 6 and show which of them more likely are in each cluster.

The plot of silhouette coefficients (Fig. 11), built by the clustering results of *fanny()* method applied to the Second data set, shows the average level of the silhouette width 0.56. It is rather sufficient result and we can see that most of data points are assigned to the right cluster. But some of them are still on the wrong place.

The summarized results of fuzzy clustering by *fcm()* function applied to both data sets are presented in the Table 6.

Table 6. Fuzzy clustering results for $c = 3$.

Clusters	Regions	
	First data set	Second data set
1	2, 4, 5, 6, 8, 11, 12, 16, 18, 23	7, 9, 12, 14, 19
2	3, 7, 10, 13, 14, 20, 21	1, 2, 5, 6, 8, 10, 11, 13, 15, 16, 17, 18, 20, 21, 22, 23, 24
3	1, 9, 15, 17, 19, 22, 24	4, 3

As we can see, there were obtained the three fuzzy clusters for each set of economic indicators, and the different partitions of Ukrainian regions show the regional development disparities, which could be analysed and used in decision making process concerned to the economic strategies.

Looking at the fuzziness of these partitions, we can admit that the regions with the average values of membership coefficients are on the boundary of the neighbour clusters, and the strategies for them must be the mixture of the corresponding strategies of the neighbour clusters.

4.2.2 Four Clusters.

The similar clustering analysis (Fig. 12) were conducted for the case of four clusters ($c = 4$). The results obtained by hierarchical clustering (*hclust()*, “complete”) are in the Table 7.

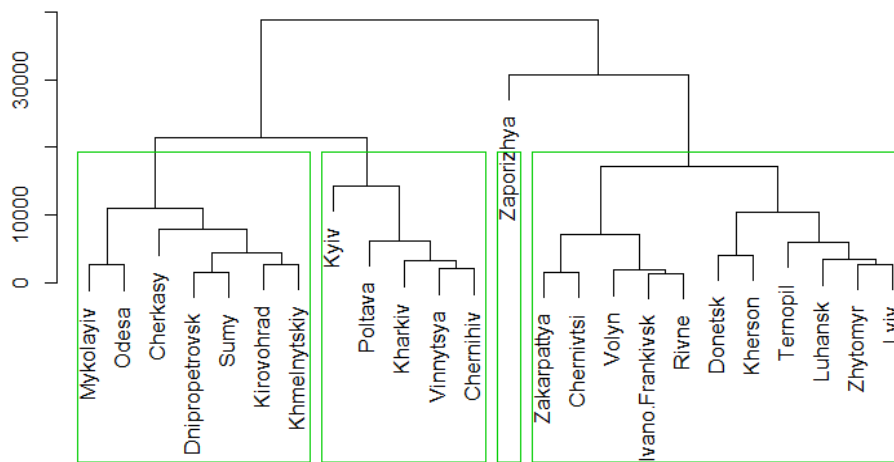

Fig. 12. Four clusters for the First data set.

Table 7. Hierarchical clustering results for $c = 4$.

Clusters	Regions	
	First data set	Second data set
1	3, 10, 13, 14, 17, 21, 22	3
2	1, 9, 15, 19, 24	4
3	7	14
4	2, 4, 5, 6, 8, 11, 12, 16, 18, 20, 23	1, 2, 5, 6, 7, 8, 9, 10, 11, 12, 13, 15, 16, 17, 18, 19, 20, 21, 22, 23, 24

The fuzzy clusters also are presented by different values of membership coefficients (we do not place them here because of the size). But these fuzzy clusters are quite completely described by the overlapping shapes at Fig. 13 and we can say that the plot of two principal components capture around 85.3% of the information about the multivariate data.

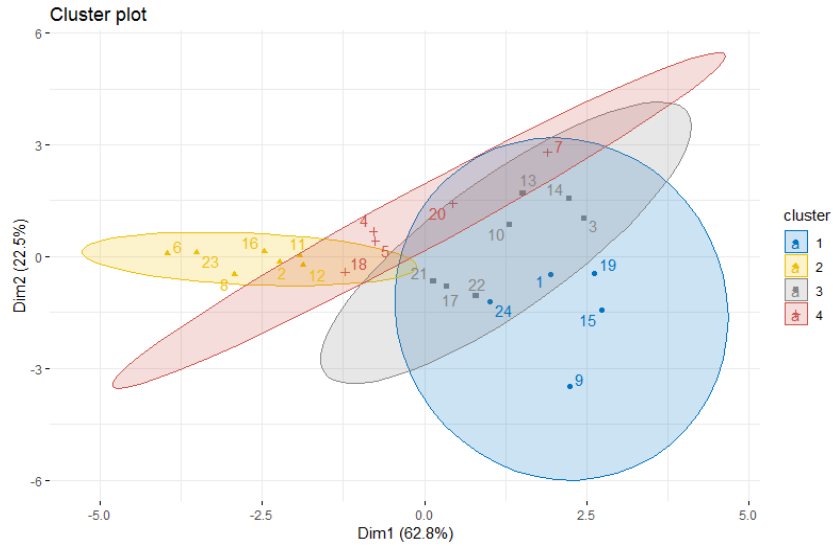

Fig. 13. Plot of the fuzzy clusters for the First data set.

The fuzzy clusters based on the Second data set we represented by the plot, where the data points with the highest values of the membership coefficients are combined into four different clusters (Fig. 14). Here we have the only two big groups of data points and two data points are stand alone in different clusters. So, the further analysis with larger number of clusters is not rational.

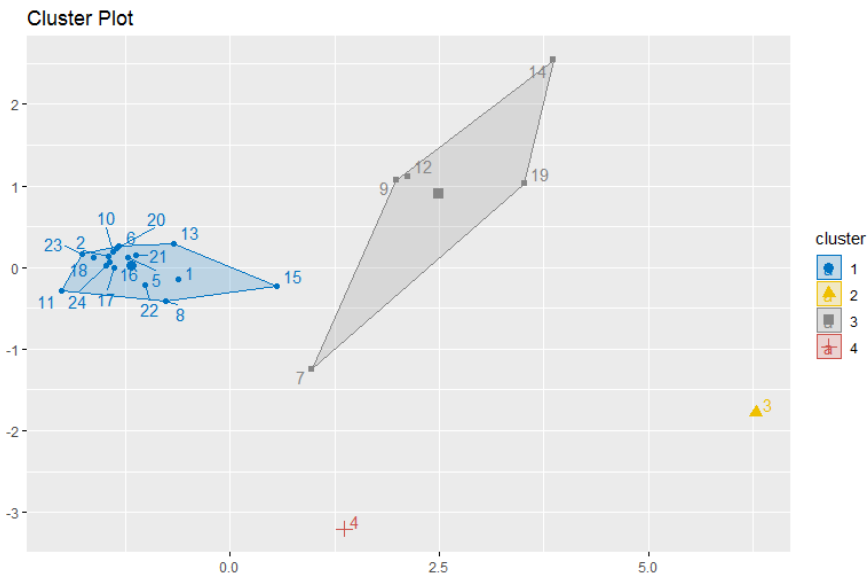

Fig. 14. Plot of the fuzzy clusters for the Second data set.

The summarized results of fuzzy clustering by $fcm()$ function applied to both data sets are presented in the Table 8.

Table 8. Fuzzy clustering results for $c = 4$.

Clusters	Regions	
	First data set	Second data set
1	1, 9, 15, 19, 24	1, 2, 5, 6, 8, 10, 11, 13, 15, 16, 17, 18, 20, 21, 22, 23, 24
2	7, 13, 14, 20	3
3	3, 10, 17, 18, 21, 22	7, 9, 12, 14, 19
4	2, 4, 5, 6, 8, 11, 12, 16, 23	4

So, there were obtained the four fuzzy clusters for each set of economic indicators. These different classifications of Ukrainian regions show the disparities in regional development, which can be analysed and used in the decision-making process concerning economic strategies. Including into the analysis the fuzzy nature of obtained partitions, we will gain the new quality of forming of the economic strategies for different regions.

5 Results and Discussion

The results of fuzzy clustering obtained in this study allows to consider in more detail the similarities in the economic development levels of the Ukrainian regions, which are assigned to the same clusters, and reveal the dissimilarities between the regions assigned to the different clusters. The membership coefficients give us the information how far are the development levels within clusters and between clusters.

This alternative approach can help determine the regional development disparities according to certain indicators. As we showed in this research, the results of partitioning strongly depend on the indicators selected for the analysis, and any clustering technique should be used only along with the substantial analysis of the subject of interest. Before conducting fuzzy clustering, in order to ensure proper economic interpretation of clustering results, a profound analysis of the nature of all economic indicators and relationships between them should be used.

In general, fuzzy clustering results could not be significantly different from hard clustering results. It is quite reasonable, and we could see this in practice. Although the concepts of hard and fuzzy clustering are rather different, they have common features, and the clusters obtained by different methods predominantly overlap.

The main findings in this research were the conclusions about the regional disparities in the levels of different kinds of economic activities in Ukraine in 2017. Thus, after the analysis of most agricultural indicators, we mark that among Ukrainian regions, Zaporizhya is the region, which level is significantly different from others. But the analysis of most industrial indicators allows to sign that Dnipropetrovsk and Donetsk regions, as well, are the regions, which levels significantly differ from others.

6 Conclusion

Regional disparities in economic development level had been analysed in this study by different clustering techniques. We obtained the classifications based on two groups of economic indicators observed in 2017 for all Ukrainian regions. Now, we can conclude that the regional inequalities across Ukrainian regions can be reduced by the right economic policies if the information about the actual magnitude of differences between the regions will be available before the decision-making process. The fuzzy clustering methods give us the instrument for the estimating these degrees of differences based on the analysis of regional economic activities in target sectors.

We showed, that implementation of fuzzy clustering methods in analysis of regional disparities have many advantages, but it needs to be accompanied with the cluster validity process and substantial analysis of the economic indicators, which we take as the base of the clustering investigation. In further researches, we need to take into consideration the necessity of aggregating the different fuzzy clustering results for developing recommendations on how to differentiate economic policies in order to achieve maximum growth for the regions and the entire country.

References

1. Munandar, Tb.: Analysis of Regional Development Disparity with Clustering Technique Based Perspective. *International journal of advanced research in computer science*. **6**(1), 137–141 (2015)
2. Munandar, Tb., Azhari, Musdholifah, A., Arsyad, L.: Modified agglomerative clustering with location quotient for identification of regional potential sector. *Journal of theoretical and applied information technology*. **95**(5), 1191–1199 (2017)
3. Munandar, Tb., Retantyo, W.: Fuzzy-Klassen Model for Development Disparities Analysis based on Gross Regional Domestic Product Sector of a Region. *International Journal of Computer Applications*. **123**(7), 17–22 (2015)
4. Novkovska, B.: Regional Development Disparities And Their Connection With Hidden Economy. *UTMS Journal of Economics*. **8**(2), 151–158 (2017)
5. Lukovics, M.: Measuring Regional Disparities on Competitiveness Basis. In: Bajmócy, Z., Lengyel, I. (eds.) *Regional Competitiveness, Innovation and Environment*, pp. 39–53. JATEPress, Szeged (2009)
6. Nosova, O.: The Innovation Development in Ukraine: Problems and Development Perspectives. *International journal of innovation and business strategy*. **2**, 1–13 (2013)
7. Spicka, J.: The Economic Disparity in European Agriculture in the Context of the Recent EU Enlargements. *Journal of Economics and Sustainable Development*. **4**(15), 125–134 (2013)
8. Hryhorkiv, V., Verstiak, A., Verstiak, O., Hryhorkiv, M.: Regional Economic Growth Disparities in Ukraine: Input-Output Analysis Approach. *Scientific Annals of Economics and Business*. **64**(4), 447–457 (2017)
9. Maksymenko, S.: Ukraine's Regional Economic Growth and Analysis of Regional Disparities. Working Paper 6053, Department of Economics, University of Pittsburgh (2016)
10. Zadeh, L.A.: Fuzzy Sets. *Information and Control*. **8**, 338–358 (1965).

11. Gosain, A., Dahiya, S.: Performance Analysis of Various Fuzzy Clustering Algorithms: A Review. *Procedia Computer Science*. **79**, 100–111 (2016)
12. Miller, D.J., Nelson, C., Cannon, M.B., Cannon, K.P.: Comparison of Fuzzy Clustering Methods and Their Applications to Geophysics Data. *Applied Computational Intelligence and Soft Computing*. **2009**, Article 876361 (2009)
13. Malhotra, V.K., Kaur, H., Alam, M.A.: An Analysis of Fuzzy Clustering Methods. *International Journal of Computer Applications*. **94**(19), 9–12 (2014)
14. Yang, M.-S.: A survey of fuzzy clustering. *Mathematical and Computer Modeling*. **18**(11), 1–16 (1993)
15. Joopudi, S., Rathi, S.S., Narasimhana, S., Rengaswamyb, R.: A New Cluster Validity Index for Fuzzy Clustering. *IFAC Proceedings Volumes*. **46**(32), 325–330 (2013)
16. Ruspini, E.H.: Numerical methods for fuzzy clustering. *Information Sciences*. **2**(3), 319–350 (1970)
17. Ruspini, E.H.: A new approach to clustering. *Information and Control*. **15**(1), 22–32 (1969).
18. Gitman, I., Levine, M.D.: An Algorithm for Detecting Unimodal Fuzzy Sets and its Application as a Clustering Technique. *IEEE Transactions on Computers*. **C-19**(7), 583–593 (1970)
19. Kassambara, A.: Advanced clustering. *DataNovia*. <http://www.datanovia.com/en/courses/advanced-clustering> (2018). Accessed 22 Jan 2019
20. RPubs, Unsupervised Learning - Clustering Fuzzy C Means. <http://rpubs.com/rahulSaha/Fuzzy-CMeansClustering> (2018). Accessed 12 Feb 2019
21. Ferraro, M.B., Giordani, P.: A toolbox for fuzzy clustering using the R programming language. Workshop on Clustering methods and their applications. http://pro1.unibz.it/projects/Clustering_Methods_2014/Ferraro.pdf (2014). Accessed 18 Jan 2019
22. Jain, A.K., Murty, M.N., Flynn, P.J.: Data Clustering: A Review. *ACM Computing Surveys*. **31**(3), 264–323 (1999)
23. Bellman, R., Kalaba, R., Zadeh, L.A.: Abstraction and pattern classification. *Journal of Mathematical Analysis and Applications*. **13**(1), 1–7 (1966).
24. Giordani, P., Ferraro, M.B., Serafini, A.: Package ‘fclust’. CRAN. <http://cran.r-project.org/web/packages/fclust/fclust.pdf> (2018). Accessed 12 Feb 2019
25. Cebeci, Z., Yildiz, F., Kavlak, A.T., Cebeci, C., Onder, H.: Package ‘pplust’. CRAN. <https://cran.r-project.org/web/packages/pplust/pplust.pdf> (2019). Accessed 12 Feb 2019
26. Maechler, M., Rousseeuw, P., Struyf, A., Hubert, M.: Package ‘cluster’. CRAN. <https://cran.r-project.org/web/packages/cluster/cluster.pdf> (2018). Accessed 12 Feb 2019
27. Kassambara, A., Mundt, F.: Package ‘factoextra’. CRAN. <https://cran.r-project.org/web/packages/factoextra/factoextra.pdf> (2017). Accessed 12 Feb 2019
28. Dunn, J.C.: A fuzzy relative of the ISODATA process and its use in detecting compact well-separated clusters. *Journal of Cybernetics*. **3**(3), 32–57 (1973).
29. Bezdek, J.C.: Cluster validity with fuzzy sets. *Journal of Cybernetics*. **3**(3), 58–73 (1974).
30. Bezdek, J.C.: *Pattern recognition with fuzzy objective function algorithms*. Kluwer Academic Publishers, Norwell (1981).
31. State Statistics Service of Ukraine. <http://www.ukrstat.gov.ua/> (2019). Accessed 20 Feb 2019
32. Gorbatiuk, K., Mantalyuk, O., Proskurovych, O., Valkov, O.: Analysis of regional development disparities in Ukraine with fuzzy clustering technique. *SHS Web of Conferences*. **65**, 04008 (2019). doi:10.1051/shsconf/20196504008

Critical Phenomena Study in Economic Systems Using a Damped Oscillations Model

Hanna Danylchuk^[0000-0002-9909-2165], Liubov Kibalnyk^[0000-0001-7659-5627]
and Olexandr Serdiuk^[0000-0002-3919-4661]

Bohdan Khmelnytsky National University of Cherkasy, 81, Shevchenko Blvd., Cherkasy,
18000, Ukraine

abdanylchuk@gmail.com, liubovkibalnyk@gmail.com, serdyuk@ukr.net

Abstract. The article describes the construction of a model for the analysis and forecasting of critical phenomena in economic systems based on the equation of the damped oscillations. The model of the damped oscillations based on the analysis of wavelet coefficient energy allows identifying critical phenomena, in the first place, crashes. Two parameters of the model, the initial phase and the damping coefficient, are the most appropriate for the analysis and prediction of the critical events in the economic systems. The sequence of steps for conducting research is presented and the possibility to automate the process of predicting critical phenomena is described. Critical phenomenon can be predicted based on the initial phase and the damping coefficient, the prediction horizon depends on the scale at which the model of the damped oscillations was constructed. The study of the results of the model is based on the known crashes and shocks given in the work.

Keywords: crises, crash, time, series, financial, markets, energy, surface, wavelet-coefficients, damped, oscillations, prediction, horizon.

1 Introduction

In recent years, the direction of research in both fundamental and applied sciences has significantly expanded and become interdisciplinary. In most cases, objects that are complex systems are used. The main purpose of the research is to understand the structure and dynamics of the complex system development. These characteristics will allow efficient managing of the systems and predicting their development. The prediction of bifurcation points in the evolution of singular point system, the analogues of which are critical or crisis points, in economic systems is significant among the objectives of forecasting. Critical points are clearly expressed in the dynamics of economic systems: these are known crises, crashes and shocks that were observed in the markets of the last century and continue to be observed in the current century.

Critical events are those ones that violate the normal course of the system operation, regardless of its nature: whether it is an ordinary household with one person, or a huge state with its entire population and the state system. In the Oxford English Dictionary, “critical” means “the nature or constituent part of the crisis, which includes uncertainty

as a result”, and critical is a key, decisive concept [1].

The physical analogy of such a concept may be a change in the state or phase of the system, for example, the critical phenomenon is the transformation of water from liquid into a gaseous state at the point of boiling water.

Johansen and Sornette consider crash to be a large change in the economic system performance, in particular, prices on currency and stock markets, economic indices, especially if these changes take place in the direction of decrease. Determining the characteristics and causes of such falls is particularly important for task monitoring, risk management and for placing an investor’s portfolio on the market. In accordance with the classical economic theory, the complex trajectory of price movement, in particular in stock markets, fully and truthfully reflects the flow of news that is interpreted and summarized by a large number of analysts and traders [3]. As a result, large losses in the system can only be the result of the unexpected negative events that are generated in it. Nevertheless, there are many facts about the existence of exogenous phenomena, shocks, such as the terrorist attack on the United States on September 11, 2001, or the attempt of the coup d’état in the Soviet Union on August 19, 1991, which led to a sharp change in the stock market prices and emergence of strong volatility [4].

The collapses of financial markets have always been the subject of profound researches in the financial economic literature. Starting from [5] and [6], the causes, nature and effects of financial market crashes have been versatilely analyzed by many authors. Some authors, such as Berlevi and Veronesi, focus on trader’s micro-level behaviour and information asymmetry to explain crashes [7]. Shiller [8] tries to analyze the prospects of studying financial market crashes in terms of behavioural finance. Li and Xue [9] rely on the actions of Bayesian investors and bind them with bubbles and crashes in the event of structural changes in the economy. At present, there are many important studies of the most significant crashes, such as the Black Monday of 1987 [8, 10], or technological bubbles [11]. Bates [6] studies stochastic volatility and significant deviations observed in the profitabilities of the US stock market over the past 85 years and relates the results obtained with the risk of a stock market crash. At the same time, there is a large number of empirical studies of financial market crashes [12, 13].

In their works, Sornette [4, 14], Johansen [2], Krugman [15], Kindleberger [16] and other researchers point out that crashes do not occur by themselves, they are preceded by long-term training in the system. As claimed the authors of the works [17], during this period, there is a change in the complexity of the system, which manifests itself through a set of indicators-precursors of the future collapse: fractal indicators, recurrent indicators, entropy indicators, network indicators, etc. Preferably, such training is observed in the form of a bubble, which increases similarly to the soap bubble in real life. It is the “bursting” of the corresponding bubble that is a crash, which indicates the end of the functioning of a particular mechanism taking place over a period of time in the system, and the transition of the system to another phase of its evolution.

An economic bubble (synonymous with “speculative bubble”, “market bubble”, “price bubble”, “financial bubble”) is a state of the system (market), when the valuation of a paper or the whole portfolio by traders begins to significantly deviate from their real prices. Such a situation may be explained, in particular, by unfounded and significantly overstated expectations of owners regarding the profitability of assets.

Many economists point to the prominent role of financial bubbles in the development of economic systems [18, 19]. Indeed, bubbles increase volatility, destabilize markets, and increase the fragmentation of the entire financial system [20].

Different directions of bubble modeling are described in the economic literature, but the behaviour of the crowd is common in all areas, due to which high volatility is created in the system and the risk of assets loss is increased. In addition, by analogy with physics, external or internal events being common for all, like news, have a significant effect on the financial bubble. Eventually, one of these effects becomes the key one for the bubble ‘burst’.

Crashes are often preceded by crises. This phenomenon is multifactorial and does not have a single approach and unambiguous interpretation in the scientific literature. The crisis is a profound disorder of the economic system, accompanied by the process of its transformation, adaptation to new conditions of existence, reforming, which leads to the changes of its important parts. A narrower definition of the crisis may be the following one: a crisis is a situation where there is a serious violation of one part of the system, which may be an impetus to the formation of crisis situations in other parts of the system and is accompanied by a sharp drop in the indicators of its function, the violation of links between its parts, which, as a result, can lead to its complete collapse or transformation.

The article considers the possibility of constructing a model based on the equation of the damped oscillations to analyze critical phenomena and to determine the possibility of their prediction based on the “bubbles” effects in the development of these phenomena.

The article has the following structure. Section 2 describes the background for the emergence of a “bubble” development before crashes in economic systems. Section 3 gives data on the basis of which the research is conducted. Section 4 describes the developed model based on the equation of the damped oscillations. This model is analyzed and the obtained data are evaluated in section 5. Section 6 presents the findings of the study.

2 Analysis of Previous Researches

The peculiarity of crisis development in complex economic systems is the presence of log-periodic oscillations first analyzed in Sornette’s works [2, 21, 22]. Based on the analysis of pre-crisis behaviour, Sornette describes a function dependent on several parameters (up to 8) that approximates the time series on the investigated interval and allows for short-time extrapolation to predict a critical phenomenon.

Sornette considers two types of models that represent two opposite views about the risk associated with potential crashes: risk-based models and cost-based models. We focus on the second kind of models.

Sornette focuses on the class of models with a positive feedback proceeding from the fact that the world and the stock market are nonlinear systems, the basis of which is more complex dependencies than the simple proportion between causes and effects. In this case, it means that in the absence of control, the price increases without restrictions.

This model has interesting and far-reaching consequences in terms of crash repetition and organization in time. Indeed, whenever random walks approach the chosen constant value W_c , the price of the bubble flies up, and, accordingly, to the absence of control, along with rational expectations, it means that the market goes into an unstable state with a subsequent crash. The random walks model provides a very accurate prediction of the waiting time between successive approximations to the critical value W_c , i.e., between successful bubbles.

The formulation of the “bubble” model of “singular inverse random walk”, which is guided by price, can convincingly reproduce certain properties and the appearance of real price paths, with their chance, bubbles and crashes.

The process of gradually increasing / decreasing bubbles with a period that continuously decreases with time, corresponds to log-period variations of the values of the pre-crisis time series.

The practical consequences of log-periodic structures should be emphasized. For forecasting purposes, the part of the data that contains oscillations is more important than that described by a simple power dependence that can be degenerate, especially in the presence of noise; therefore, the oscillating component of the data is more reliable. Besides, log-periodic property (allows selecting a weak signal against a background of high noise) provides more reliable compliance with data. Log-periodicity is very important from the empirical point of view in the analysis of financial information, since such oscillations are much better seen in real data than simple power dependence. The model compliance can be focused on oscillations that contain information about a critical date t_c . If the data have log-periodicity, it can be used to predict critical time simply by extrapolating the acceleration frequency.

Since the probability of a crash is the highest at the critical time, one can predict the point of crash. However, such a forecast is ineffective for rational traders, because they know the risk coefficient of a crash at each point of the path (including t_c), and they have already reflected this information in prices due to the condition of rational expectations.

The main assumption of the theory that describes the above model is the cooperative behaviour among traders imitating each other. The difference from others is the thought that the main cause of the crash should be sought a few years before its implementation in the gradual acceleration of the growth of market prices that shows the increasing accumulations of cooperative market [22].

Sornette considers the imitation effect among traders to be the main cause of the emergence of speculative bubbles, with bursting of which crashes occur. The crash, according to Sornette, has an exogenous nature, and endogenous shocks are only initiating factors [22].

The generalized result of this theory, as already indicated, is the presence of log-periodic structures that accompany the evolution of the system in time.

However, the calculation of the parameters of such a function is rather bulky and contains a large number of assumptions that are inconvenient for simulation using computer technology; therefore, other approaches to modeling such time series should be sought.

The study of the coefficients of wavelet transformation executed on the pre-crisis

interval of time series for the known economic crises reveals the special behaviour of their energies before the crisis. Increasing periodic fluctuations were observed in all cases of the studied economic crises; therefore, it seems possible for the analysis of critical phenomena to use appropriate methods.

3 The Used Data

For analysis, a number of the most characteristic crashes and shocks were selected, which were investigated on the basis of time series being indicators of the following indices [23]:

- Standard&Poor’s 500 Index, US (^GSPC symbol);
- NASDAQ Composite Index, US (^IXIC symbol);
- Dow Jones Industrial Average Index, US (^DJIA symbol);
- Hang-Seng Index, Hong Kong (^HIS symbol);
- Nikkei Index, Japan (^N225 symbol);
- Index of the London Stock Exchange, UK (^FTSE symbol).

Information on the series is given in Table 1.

Table 1. Investigated critical phenomena.

Notation of the series	Index	Period of crisis phenomenon
A	S&P500	15.03.1962-27.06.1962
B	S&P500	25.08.1987-19.10.1987
C	NASDAQ	05.10.1987-28.10.1987
D	N225	14.10.1987-11.11.1987
E	NASDAQ	16.07.1990-10.10.1990
F	N225	17.07.1990-01.10.1990
G	Hang-Seng	04.01.1994-23.01.1995
H	Hang-Seng	07.08.1997-13.08.1998
I	FTSE	03.10.1997-28.10.1997
J	S&P500	17.07.1998-31.08.1998
K	FTSE	20.07.1998-05.10.1998
L	NASDAQ	20.07.1998-08.10.1998
M	S&P500	09.10.2007-09.03.2009

4 Model Construction

The model is based on a homogeneous differential equation of the second order, which describes damped oscillations or free oscillations in dissipative systems with viscous friction:

$$q'' + 2hq' + k^2q = 0. \quad (1)$$

The characteristic equation for it has the form:

$$s^2 + 2hs + k^2 = 0. \quad (2)$$

For the case of small resistance, which is of interest to us, the roots of the characteristic equation are:

$$s_1 = -h + i\sqrt{k^2 - h^2}, \quad (3)$$

$$s_2 = -h - i\sqrt{k^2 - h^2}. \quad (4)$$

The general solution of the differential equation has the form:

$$q = ae^{-ht} \sin(t\sqrt{k^2 - h^2} + \varepsilon). \quad (5)$$

We take the initial conditions $t = 0, q = q_0, q' = q'_0$. Then we get

$$a = \sqrt{q_0^2 + \frac{(q'_0 + hq_0)^2}{k^2 - h^2}}, \quad \text{tg} \varepsilon = \frac{q_0\sqrt{k^2 - h^2}}{q'_0 + hq_0}, \quad (6)$$

where a – initial amplitude, ε – phase.

So, to construct the model, it is necessary to know the initial deviation q_0 , which is known as the first element of an array of input data, the initial velocity q'_0 , which can be found by linear regression, the method of the smallest squares of few first values of the input data, as well as damping ratio h and own frequency of the undamped harmonic oscillations k . Damping ratio h can be found by constructing a dependence $q(t)$ on a semi-logarithmic scale and taking the slope of the line, which interpolates the points of the received graph. The proper frequency of non-damped harmonic oscillations, which in this case, will be approximately equal to the frequency of damped oscillations $\sqrt{k^2 - h^2}$, is found by means of the calculation of the function zeros, thus obtaining the period of oscillations, from which the desired value is calculated by the formula $k = \frac{2\pi}{T}$.

The algorithmic construction of the model consists of the following steps.

1. The surface of wavelet coefficients of the time series is constructed using continuous or discrete wavelet transformation. Since wavelet coefficients are obtained in the complex domain in some cases, there are their energies to display in the real domain.
2. The scales on which a sample of wavelet coefficients will be selected for further construction of the model, are selected (Fig. 1).

In most cases, several scales can be selected that show the most pronounced increasing oscillations of the wavelet coefficients (e.g., scales from segments [1, 50], [50, 100], and [200, 255] in Fig. 1). For a more precise choice of scales, the energy of scales is calculated as the sum of energies for each of the scales, resulting in a “profile” of the energies of the wavelet coefficients (Fig. 2).

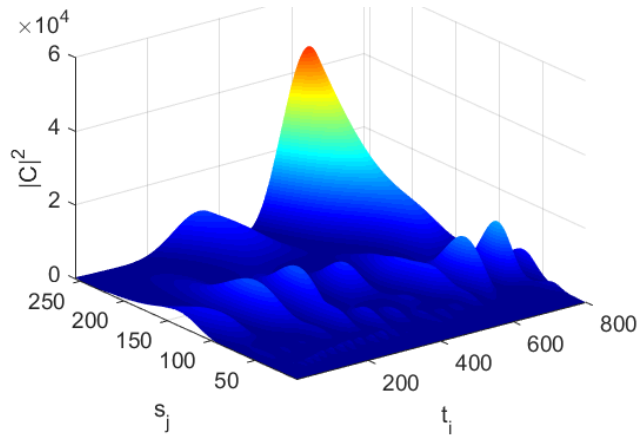

Fig. 1. Energy surface of wavelet coefficients for DJIA index containing 800 points for the period from 19.12.2003 to 19.07.2007. A discrete wavelet transformation of time series is used with scales from 1 to 256.

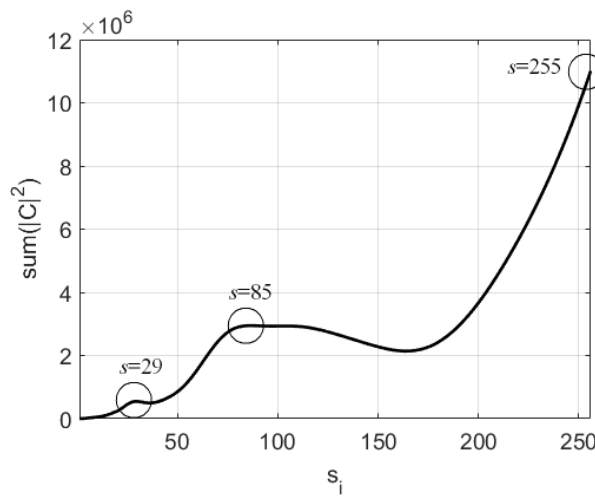

Fig. 2. Scale energy profile for wavelet coefficients of DJIA index containing 800 points for the period from 19.12.2003 to 19.07.2007. The profile sections, according to which the scales are selected for further model construction, are circled.

Based on the obtained profile of scale entropy, the scales corresponding to the local maxima of the profile are selected (sometimes, the areas where the derivative is positive, but close to 0, are selected).

Fig. 3 shows the nature of the oscillations obtained for scales $s = 85$ and $s = 255$. Due to the fact that the damped nature of oscillations is clearer on a larger scale, it is

proposed to choose the largest scale found that meets the criterion of a local maximum.

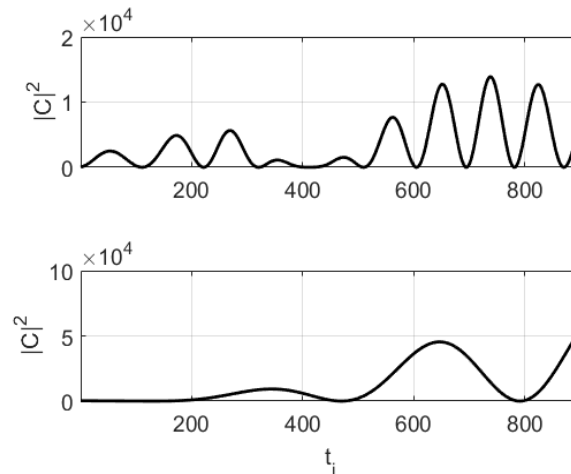

Fig. 3. Energies of wavelet coefficients of DJIA index containing 800 points for the period from 19.12.2003 to 19.07.2007 obtained for the scale $s = 85$ (fig. above) and $s = 255$ (fig. below).

3. In case there is a group of scales with the same local scale, different methods can be used to select necessary scale. One of the options may be the use of the largest scale from the group that meets the scaling criteria described in step 2. Another option may be the estimation of the derivative characteristic calculated on the basis of the selected energy values of the wavelet coefficients, which, however, complicates the analysis process without providing any significant improvements.
4. For each of the series obtained in stage 3, there are parameters of the damped oscillations of the model described above.

5 Analysis of Model Application

The presence of log periodicity in time series was checked by interactive construction of a mathematical model including the following transformations:

1. the search of the degree trend by the method of coordinate descent and the method of the least squares;
2. search for the curvature of the envelope;
3. approximation of a series with sinusoidal;
4. bringing the graph of the time series to one or both axes, subtracting the mean, exponentiating or logging the abscissa.

The sequence of actions consisted in finding another transformation, to execute it, and to obtain a residual series transmitted for further processing.

An example may be the process of constructing a mathematical model for the

development of the bubble before the crash of 19.10.1987 based on the Standard & Poor's 500 series taken from 16.08.1984 to 10.15.1987, which allows assessing the behaviour of the economic system in the period before the crash.

The presence of a power trend can be seen from the initial series (Fig. 4, "S&P500" graph). It is explained by the development of the economy until 1987. The estimation of the trend parameters by the least square method gives the equation

$$f(x) = 0.0002x^2 + 0.0737x + 162.7651. \quad (6)$$

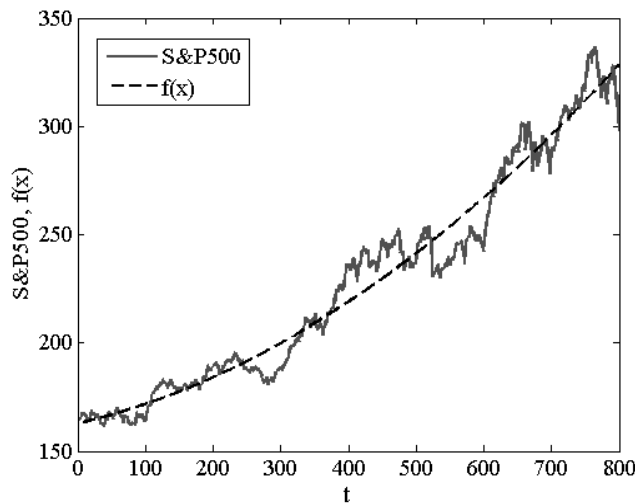

Fig. 4. S&P500 index taken from 16.08.1984 to 15.10.1987 period and obtained power trend for it (" $f(x)$ ").

It should be noted that in general, we are not interested in the absolute values of the parameters of functional dependences used to describe a particular mechanism, but only in the type of dependencies and signs of coefficients. The found trend is the base and serves as the basis on which the changes in the index values obtained in the future, are imposed.

After subtraction a number of values of the found trend from the series values, the behaviour of the economic system can be observed on a smaller scale. For further investigation, the values of the series were initially normalized, resulting in the change of the ordinates of the points, and then the abscissas of the points were brought to the interval $[0, 1]$. As a result, there is an increase in the frequency of oscillations when displacing in the positive direction of the abscissa axis, indicating the presence of log periodicity and requiring the inclusion of relevant elements in the mathematical model.

After the exponentiation of abscissa, a series is obtained which can be approximated by trigonometric function due to the presence of periodic oscillations.

The following sinusoidal trend was found for the obtained series (Fig. 5):

$$f(x) = -0.3742\sin(-18.8296x + 76.1417). \quad (7)$$

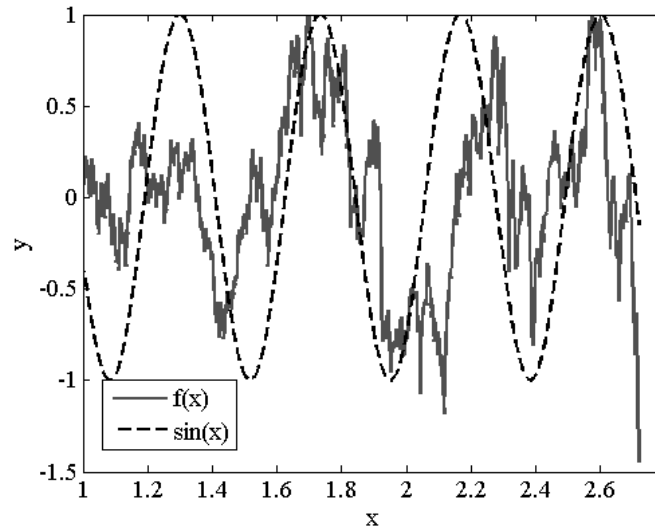

Fig. 5. Row for analysis (“ $f(x)$ ”) with the found sinusoidal trend (“ $\sin(x)$ ”).

Analysis of the obtained sinusoid allowed determining the period of 200 points. This period for the initial series is somewhat different: it is bigger at the beginning, and it is smaller at the end, because of exponentiating of abscissa axis preceding it. That is, the synchronous behaviour of the economic system agents was initially characterized by the slower fluctuations that began to accelerate as they approach the crash. It is about this kind of behaviour of economic systems before the critical phenomena that Sornette says in his works.

After removing the sinusoidal trend, the information remaining in the series corresponds to the actions of market agents on the scales being equal to months, weeks and days. Further construction of the mathematical model, due to finding the fact of log-periodicity, is no longer significant.

Summarizing the above, we can draw the following conclusions regarding the obtained mathematical model and mechanism of crisis development in 1987 on the basis of the Standard&Poor’s 500 Index:

1. Market behaviour before a crash is described with the parabolic trend, on which a sinusoid is imposed with a period of about 10 months (200 points). However, exponential stretching of the abscissa axis before searching a sinusoid indicates an increase in the frequency of oscillations when approaching a critical phenomenon.
2. On small scales, the behaviour of the market repeats the model analyzed and described by Sornette, whose main feature is log-periodic oscillations.
3. On the basis of the constructed mathematical model, one can speak of the gradual growth of a bubble characterized by log-periodic fluctuations, or about “overheating of the market”, one of the main factors of which, according to Sornette, is individual players of the market, whose ordered motion plays one of the key roles.

4. The behaviour of other investigated time series before the critical phenomena repeats the situation described above, however, the available and additional properties of the analyzed time series, in particular, more acceleration of oscillations, requiring double exponentiation of the abscissa axis, and the second sinusoidal trend observed after the first trend. These properties require additional studies of economic system behaviour prior to critical phenomena and can serve as additional criteria for a more profound classification of critical and crisis phenomena.

The study also points to weaker hypothesis of the “inefficient market”, according to which market prices, in addition to general available information, also contain more detailed and concealed information formed by the global market. It can be claimed more generally that economic systems contain and receive information both inside and outside; however, each piece of information is essential for certain levels or scale systems.

To study the work of model (1)-(6) for the purpose of further analysis, the following parameters were calculated:

1. initial amplitude a ;
2. initial phase ε_0 ;
3. the frequency of the undamped harmonic oscillations k ;
4. damping ratio h ;
5. period T ;
6. the residual sum of *squares* \hat{S} .

Since both parameters providing useful information about the state of the system and the possibility of their use for analyzing and predicting the state of the systems are unknown, the study is conducted using a moving window procedure as in the previous sections. For this, the series to be analyzed is cut from the original one so that it contains 800 points to the point of the first drop, and 250-300 points after it. 800 points before the first drop include a window with a width of $win=500$ and 300 additional points for moving the window approaching the critical point. The step of the window displacement is set equal to $step=2$, which allows conducting the detailed analysis of parameter change.

The general algorithm of the procedure in one step is as follows:

1. Selecting a subset with a length equal to the width of the window, and the execution of its wavelet transformation. The type of discrete wavelet transformation with the given scales, scale from 1 to 256, is set as parameters for a wavelet transformation.
2. Determining a profile of energies, calculated as the sum of energies of wavelet coefficients on each scale.
3. Determining the points of local maximum, with the local maximum being considered only such a point, to the left and to the right of which the neighbouring points have lower values for it. Thus, local maxima are not considered to be the points that correspond to the largest scale, for which there is often a similar tendency (Fig. 2, scales > 250). The rejection of such points is explained by the fact that on the largest

scale, $s > 250$, there is a smooth dynamics of the series including a lot of noise information, unnecessary for analysis.

4. Choosing the largest scale among the found, s_{act} , and cutting of a series corresponding to the chosen scale, from the surface of the energies of wavelet coefficients.
5. Calculating the model parameters of the damped oscillations on the basis of a cut series.
6. Saving the parameters, and if there is a subsequent window, then going to it and returning to step 1.

Since it turned out during test launches that the actual scale s_{act} varied when windows were shifted, it was decided to use it as a parameter for the study. The critical phenomena presented in Table 1 were studied, for which the corresponding output series were used.

To get rid of large fluctuations at the moments of new waves, Kalman filter was used. The feature of the filter is the possibility of filtering by means of the weighted coefficients taking into account the proximity of points: the adjacent point to the given one has a greater weight than the distance one. To implement, the filter was chosen described by the following general equation:

$$x_k = Ax_{k-1} + Bu_{k-1} + w_{k-1}, \quad (8)$$

which applies to the sequence of measurements

$$z_k = Hx_k + v_k, \quad (9)$$

where variables w_k and v_k are, respectively, process noise and measurement noise; matrix A corresponds to the filter state in the previous period $k-1$ during the transition to the next period k ; matrix B contains the parameters of the influence of the variable u on the variable x ; the matrix H is connected with the state of measuring the variable z . During the filter work, matrix A and B are constant, while the value of the matrix H is adjusted after each step.

When the Kalman filter was implemented, the deviation values $Q=10^{-6}$ were used to obtain a smoother series (with $Q=10^{-5}$ in the output, a series repeating the input one is received), and variation estimates of measurements $R^2=0.01$.

Filtration allows receiving smoother graphs of indicators that helps to apply automatic procedures more precisely for estimating and forecasting values; although on the other hand, the dynamics of the indicators is somewhat different from the one calculated initially.

The study conducted on the basis of the critical phenomena presented in Table 1, shows the highest sensitivity of the initial phase ε_0 and damping coefficient h ; moreover, the starting phase was often used as the indicator for predicting.

The prediction based on the model of the damped oscillations consists in tracking the dynamics of ε_0 and h indicators, determining the area of the observed indicator with small fluctuations and calculating the maximum point of the next wave.

Table 2 shows the results of prediction based on the initial phase.

Table 2. Results of predicting critical phenomena based on the initial phase.

Critical phenomena	Point where the forecast was made	Predicted point	Deviation from the point of the first drop of the index
A	174	322	+22
B	162	280	-20
C	132	212	-88
D	168	312	+12
E	110	230	-70
E	246	359	+59
F	158	353	+53
F	226	354	+54
G	112	225	-75
H	178	317	+17
I	256	319	+19
K	214	359	+59
L	148	369	+69
M	226	436	+136

Based on the coefficient of damping cases, the prediction turned to be less due to less clear dynamics of the indicator (Table 3). Like in predicting based on the initial phase, the estimation of the model parameters started 300 days before the first drop of the economic indicator for corresponding crash. The longest period of time to be predicted was 200 days before a crash started.

Table 3. Results of predicting critical phenomena based on damping coefficient.

Critical phenomena	Point where the forecast was made	Predicted point	Deviation from the point of the first drop of the index
B	138	268	-32
D	136	289	-11
E	100	180	-120
G	244	397	+97
H	138	280	-20
I	136	289	-11
J	174	324	+24
K	178	329	+29
L	140	363	+63
M	158	337	+37

It is worth noting that due to the exogenous nature of shocks, their prediction was almost impossible; since in the economic system, there is no change before the shock due to, for the most part, the lack of information about the impending critical phenomenon. Nevertheless, some of the shocks, about which the information gets into the economic system, can be tracked in advance; however, our study showed the need to improve the model with the aim of increasing its sensitivity.

Forecasting crashes on the basis of a model of the damped oscillations showed the effectiveness of the model, since most of the crashes were predicted.

The estimation of the model parameters began 300 days before the first drop of the

economic index for the corresponding crash. The longest period of time, for which the forecast was made, was 190 days before the crash. However, it can be explained by the large period of bubble growth before the crash, which allowed revealing it long before the crash rather than the perfect work of the model.

6 Conclusions

The following conclusions can be drawn on the basis of the study.

1. The model of the damped oscillations based on the analysis of wavelet coefficient energy allows identifying critical phenomena, in the first place, crashes.
2. The initial phase ε_0 and the damping coefficient h are the most appropriate for the further analysis; other indicators are calculated with a large margin of error, which does not allow them to be used for prediction.
3. Critical phenomenon can be predicted based on the initial phase ε_0 and the damping coefficient h ; moreover, the prediction horizon is mostly within the boundaries of (–150, 150) days, and it is essential that the prediction horizon depends on the scale at which the model of the damped oscillations was constructed.

7 Acknowledgements

We express our gratitude to Prof. Soloviev V. for the consultations provided and fruitful discussion of the obtained results.

References

1. Oxford English Dictionary Online. <http://www.oed.com/> (2019). Accessed 21 Mar 2019
2. Johansen, A., Sornette, D.: Shocks, crashes and bubbles in financial markets. Brussels Economic Review (Cahiers economiques de Bruxelles). **53**(2), 201–253 (2010)
3. Cutler, D., Poterba, J., Summers, L.: What Moves Stock Prices? *Journal of Portfolio Management*. **15**(3), 4–12 (1989)
4. Sornette, D., Malevergne, Y., Muzy, J. F.: What causes crashes? *Risk*. **16**(2), 67–71 (2003)
5. Fisher, I.: *The Stock Market Crash – and After*. Macmillan Company, New York (1930)
6. Bates, D.S.: US stock market crash risk. *J. Financ. Econ.* **105**(2), 229–259 (2012)
7. Berlevi, G., Veronesi, P.: Rational panics and stockmarket crashes. *J. Econ. Theory. I.* **110**, 234–263 (2003)
8. Shiller, R.J.: Fashions, fads and bubbles in financial markets. In: Coffee, J.C. (ed.) *Knights, Raiders and Targets*, pp. 56–68. Oxford University Press, Oxford (1987)
9. Li, C., Xue, H.: A Bayesian's bubble. *J. Finance*. **64**(6), 2665–2701 (2009)
10. Bates, D.S.: The crash of '87: was it expected? The evidence from options markets. *J. Finance*. **46**(3), 1009–1044 (1991)
11. Griffin, J.M., Topaloglu, S.: Who drove and burst the tech bubble? *J. Finance*. **66**(4), 1251–1290 (2011)
12. Choudhry, T.: Stock market volatility and the crash of 1987: evidence from six emerging markets. *J. Int. Money Finance*. **15**(6), 969–981 (1996)

13. Yang, J.K., Min, I.: Stock market integration and financial crises: the case of Asia. *Appl. Financ. Econ.* **13**(7), 477–486 (2003)
14. Sornette, D., Johansen, A.: Critical crashes. *Risk.* **12**(1), 91–94 (1999)
15. Krugman, P.: Balance Sheets, the Transfer Problem, and Financial Crises. *International Tax and Public Finance.* **6**(4), 459–472 (1999)
16. Kindleberger, C.: *Manias, panics, and crashes: A history of financial crises.* Basic Books, New York (1989)
17. Soloviev, V., Belinskiy, A.: *CCIS.* **1007**, 276 (2019)
18. Barro, R.: Rare Disasters and Asset Markets in the Twentieth Century. *American Economic Review.* **99**, 243–264 (2009)
19. Pindyck, R., Wang, N.: The Economic and Policy Consequences of Catastrophes. MIT Sloan School Working Paper. I. 4751-09, 1-26 (2009)
20. Bikhchandani, S., Sharma, S.: Herd Behavior in Financial Markets: A Review. IMF Working Paper. <http://www.imf.org/external/pubs/ft/wp/2000/wp0048.pdf> (2000). Accessed 21 Mar 2019
21. Sornette, D.A.: Crashes as critical points. *Int. J. Theor. Appl. Finance B.* **10**, 3737–3745 (1996)
22. Sornette, D.: Critical Market Crashes. *Physics Reports. I.* **378**, 1-98 (2003)
23. Yahoo Finance - Business Finance, Stock Market, Quotes, News. Verizon Media. <https://finance.yahoo.com> (2019). Accessed 20 Feb 2019
24. Danylchuk, H., Kibalnyk, L., Serdiuk, O.: Study of critical phenomena in economic systems using a model of damped oscillations. *SHS Web of Conferences.* **65**, 06008 (2019). doi:10.1051/shsconf/20196506008

Model of Bankruptcy Probability Based on the Analysis of Industrial Enterprises of Ukraine

Tetiana Melikhova^[0000-0002-9934-8722], Andriy Makarenko,
Olena Mikhailytsa and Andriy Pozhuyev

Zaporizhzhya National University, 10, Zhukovskogo Str., Zaporizhzhya, 69600, Ukraine
{tanya_zp_zgia, apm2008}@ukr.net,
{elenamikhaylutsa7, scorpio6828}@gmail.com

Abstract. In present work, the peculiarities of simulation model of enterprises bankruptcy probability that exist in European, world and domestic practices were considered. The scientific econometric approach was applied to determine the overall presence and strength of the relation between the economic indicators of industrial enterprises. A financial analysis of large industrial manufactures in the region of Ukraine was conducted. To form the information base of the study, the authors estimated liquidity, solvency, business activity and profitability ratios that affect the financial condition of enterprises. They revealed the most significant ratios of financial condition analysis. According to the analysis of existing models of bankruptcy probability in the context of these industrial enterprises, an improved model for assessing the risk of bankruptcy was proposed and evaluated. The proposed model for estimating the probability of bankruptcy, taking into account the influence of the most significant ratios of financial analysis, confirmed that the percentage of provided bankruptcies and stable activities are acceptable and indicate high quality of the resulting equation. The IBM SPSS Statistics system was used to process the data, check the assumptions and prepare valid conclusions. The improved model will allow it to be used in the practice of diagnosing the probability of bankruptcy of industrial enterprises, which will help identify the threat of bankruptcy in time and ensure stable operation of the industrial enterprise.

Keywords: the financial analysis, correlation ratio, regression, model of bankruptcy probability.

1 Introduction

One of the priorities of Ukrainian economy is the rapid development of industrial manufactures in each region. Sales volume is one of the main indicators by which the results of economic and production process of manufactures as well as the area and Ukraine as a whole are estimated. Existing threats to the internal and external environment of industrial enterprises affect the probability of their bankruptcy.

The development of economic innovative path implies, first of all, the possibility and necessity of making sound economic decisions on a strict and logically verified

basis. Mathematical and, in particular, statistical research methods make it possible to substantiate and verify the adequacy of the measures applied to a particular economic object in particular circumstances.

2 Literature Review

The main issues and description of the world problem under consideration in the present work are based on the review and analysis of foreign and domestic publications. According to authors such as I. Andryushchenko [1] a peculiar place at the macrolevel is taken by the analysis of economic performance of the Ukrainian industrial development. I. Sitak, D. Korobkov and V. Mishchenko [2] insist on the importance of analyzing the financial condition of industrial enterprises for the industry development as a whole.

The authors of [3] tried to consider the main existing trends in the area of digitization of the socio-economic sphere. The consideration is focused on the development of the country's economy that directly depends on a society digital development level.

The study of particular use of neurocomputing in financial sphere can be found in researches of A. Galushkin, O. Khlystova, A. Mints, V. Mosvenok, etc. At present, there is a widespread appearing in the domestic market of a vast number of both universal neuropackages for solving technical analysis problems and specialized expert systems and neuropackages designed for solving more complex and difficult to formalize problems from the financial field. The authors of [4-6] give a brief list of the main tasks where neurocomputers have effectiveness that is much higher than the effectiveness of both common regression analysis methods and expert systems based on the construction of a formal model of an object or phenomenon. The principles of neural networks construction and their main functioning characteristics are also described.

The characteristics of Ukrainian enterprises crisis conditions considered in [7]. To analyze the probability of bankruptcy, four economic and mathematical models were proposed and calculated using various modeling tools and different number of factors. The authors analyzed two models of linear regression and two models based on neural networks, proposed and tested several methods for predicting the bankruptcy probability at a macroeconomic level, which made it possible to obtain adequate results.

It should be mentioned, that works of several foreign scientists are devoted to the study of issues under consideration. Thus, in [8] the main principles on which the models of neural networks are based and which must be followed to be effective are presented. A comparison of the regression analysis and neural networks with the hybrid method suggested in [9] showed the superiority of the neuroregression method. A comparative analysis of the two main models for forecasting in [10] is based on the minimum predicted error. The results of the multidimensional regression approach of OLS and the non-parametric approach of the neural network were processed, and the method with the lowest average overall absolute percentage error has been defined.

Later in [11], a completely new theory of asymptotic distribution was suggested for standard methods, such as regression, correlation analysis, and covariance. The present

technique is based on a fixed time interval, which permits the number of high-frequency returns for this period to go to infinity. The authors of [12] present an algorithm for conducting statistical forecasting of economic indicators, which is based on the consistent application of individual methods of mathematical statistics to build the most reliable and adequate econometric models of indicators relationship affecting the investment and innovation potential of the region.

Researchers E. Raevneva and O. Gorokhovaya [13] believe that when conducting financial and economic activities, industrial enterprises are affected by various risks, threats to their stability, which enables bankruptcy. To ensure the economic security of an enterprise, E. Ponomarenko [14] recommend analyzing and predicting the future operation of an enterprise.

There are many foreign and domestic models for defining the probability of bankruptcy of an enterprise, namely the Altman [15], Springgate [16], Taffler and Tishou [17], Saifulin-Kadykov [18] and others models. Some of them are really based on a multivariate regression equation, others use a mixture of financial ratio analysis. They are recommended for analysis, if you need to take into account current business trends and the impact of promising technologies on the structure of financial indicators.

During of the study, a significant number of publications on this topic were found, confirming the relevance of the chosen direction. Despite the existence of different authoring methods for assessing the probability of bankruptcy, their calculation results are not always able to show the real financial situation of enterprises, as it should be borne in mind that most of the methods used are developed by foreign scientists, so the issue of their adaptation to the activities of Ukrainian enterprises remains unresolved.

3 Materials and Methods

To analyze the economic situation, various indicators are used, which are interconnected stochastically (not strictly). Using the available statistical observations, namely the sales volume on the main activities types for the period 2012-2017 for industrial enterprises of Ukraine, Zaporizhzhya region and its two profiled enterprises, the behavior of the object under study is simulated. For simulation being correct, it is advisable to use an econometric, in particular, correlative, approach, which allows to test statistical hypotheses about the presence and strength of the correlation.

The obtained correlation ratio will make it possible to establish the closeness of linear correlation between the economic indicators under consideration, to correctly determine the type of relationship – direct or indirect, and also to make the right decisions concerned the choice of various indicators analyses.

Considering the sales volume data in the metallurgical branch and mechanical engineering, the main hypothesis is put forward about the absence of a correlation link between the analyzed indicators; the hypothesis of a correlation link presence is considered as an option. The linear correlation ratio is used to assess the degree of relation closeness [19].

$$r = \frac{\text{cov}(x,y)}{\sigma_x \sigma_y} = \frac{\overline{xy} - \bar{x} \cdot \bar{y}}{\sigma_x \sigma_y} = \frac{1/n \sum_{i=1}^n x_i y_i - \bar{x} \cdot \bar{y}}{\sqrt{1/n \sum_{i=1}^n (x_i - \bar{x})^2 \cdot 1/n \sum_{i=1}^n (y_i - \bar{y})^2}}$$

where x_i, y_i are the values of the first and second measured parameters in each observation respectively; \bar{x}, \bar{y} are the average values of necessary measured parameters; n is the number of paired observations of variables X and Y ; σ_x, σ_y are the normal deviations calculated for all particular values of the first and second parameters, respectively.

For the period from 2010 to 2017, according to the statistics service (Table 1), the volume of products sold in Ukrainian industry increased by 2.06 times in metallurgy, and 1.73 times in machine-building. So, the analysis showed that for 2010-2017, the share of metallurgy in the overall volume of industrial manufactured products in Ukraine decreased by 3.4 points, and the share of machine-building decreased by 2.9 points. The factors that restrain industrial production are insufficient demand for products, lack of professional workforce, high-quality raw materials and modern equipment. Considering the sampling of data for Ukraine in metallurgical production (X) and mechanical engineering (Y) using software tools, we define the empirical value of the correlation ratio, equal to 0.775.

Table 1. The volume of industrial products sold (goods, services) by type of economic activity in Ukraine in 2010-2017.

Year \ Kind of activity	Metallurgical production		Engineering	
	UAH million	% of total	UAH million	% of total
2010	200001.9	19.1	97056.9	9.3
2011	241884.7	18.5	130847.9	10.1
2012	223294.1	16.3	140539.3	10.3
2013	207305.3	15.7	113926.6	8.6
2014	237393.0	16.6	101924.7	7.1
2015	278502.8	15.7	115261.7	6.5
2016	318195.9	14.8	131351.8	6.1
2017	411372.3	15.7	168281.9	6.4

To analyze the strength of the relationship between variables, the Cheddock scale was used, according to which, the correlation ratio in range from 0.7 to 0.9, the relations between the parameters studied are high. For the value level, the critical value of the correlation ratio is 0.71. Thus, the relation between the volume of manufactured industrial products sold in engineering and metallurgy is statistically significant at 5% level and is positive.

In view of the fact that not all regions of Ukraine are industrial, it is interesting to analyze the Zaporizhzhya region, which is one of the leaders in this area. For the period from 2012 to 2018, according to the statistics service (Table 2), the volume of products

sold in the Zaporizhzhya region in the metallurgical industry increased by 3.58 times, and in mechanical engineering it increased by 1.73 times. The analysis for 2012-2018 showed that the share of metallurgy in the total volume of products manufactured in the Zaporizhzhya region increased by 9.7 points, the share of engineering decreased by 10.5 points.

Table 2. The volume of industrial products sold (goods, services) by economic activity in the Zaporizhzhya region in 2012-2018.

Kind of activity Year	Metallurgical production		Engineering	
	UAH million	% of total	UAH million	% of total
2012	23878088.3	30.7	18061561.8	23.2
2013	22375716.1	29.5	14841908.8	19.6
2014	34250059.3	36.2	14766398.2	15.6
2015	47991811.4	36.7	19042831.6	14.6
2016	50462344.4	35.2	17448742.0	12.2
2017	71074449.0	37.8	25242565.3	13.5
2018	85428031.9	40.4	26923298.7	12.7

The decline in the machine building share occurred due to the decrease in car production and in general its complete stop by one of the leading machine-building enterprises in the Zaporizhzhya region PJSC ZAZ, as well as due to the interruption of business ties with Russian enterprises due to the antiterrorist operation in Ukraine. The growth in the share of metallurgy occurred despite the fact that many enterprises use outdated equipment and technologies, but they have qualified personnel who provide high labor productivity to enterprises.

Let's consider a sample of data on the Zaporizhzhya region in the metallurgical industry (X) and mechanical engineering (Y). Figure 1 shows the scatterplots with a regression straight line and a confidence interval, which permits visualizing the correlation between two factors, namely the sales volume in the metallurgical industry and mechanical engineering within the Zaporizhzhya region. There is a strong positive correlation. This assumption is approved by the software empirical value of the correlation ratio, that is 0.914. To analyze the strength of the relationship between the variables, the Cheddock scale was used, according to which, when the correlation ratio is above 0.9, there is a strong relationship between the parameters under consideration.

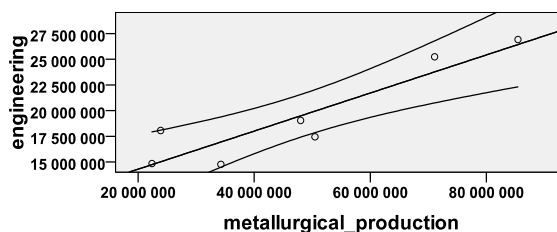

Fig. 1. Scatterplot in the Zaporizhzhya region

To define statistical reliability of the obtained value, we work with the data of corresponding Pearson's table of critical values for linear correlation ratio. For the corresponding value level $\alpha=0.01$, we find the critical value r , equal to 0.87 for this correlation analysis. Since the empirical value (0.914) is more critical (0.87), it can be concluded that the correlation ratio value is considered statistically significant. The main hypothesis about the insignificance of the correlation between qualitative signs is rejected and an alternative one is accepted. In other words, the relationship between the volume of sold manufactured products of mechanical engineering and metallurgy is statistically significant at the 1% level and is positive.

The obtained directly proportional dependence indicates that the higher the obtained correlation ratio, the higher the dependence between qualitative characteristics, and vice versa.

However, in Ukraine most of the big industrial manufactures were built in times of the Soviet Union. Based on the Report on financial results (Table 3), the volume of sold industrial products (goods, services) at PJSC "Zaporizhstal" in 2013-2017 increased by 3.4 times, and at PJSC "Motor Sich" – 1.77 times. The increase in sales volume of the analyzed industrial enterprises is more associated with the rise in prices, which are caused by inflation and the hryvnia exchange rate decline, rather than with the real growth in output volumes.

Table 3. The volume of industrial products sold (goods, services) of large enterprises of the Zaporizhzhya region in 2013-2017.

Year	Industrial enterprise	
	PJSC "Zaporizhstal"	PJSC "Motor Sich"
2013	13579218	8583924
2014	22110517	10730122
2015	31395478	13830655
2016	33158709	10546207
2017	46746886	15150429

Within the framework of two enterprises, the empirical value of the calculated ratio is 0.873, which also indicates the statistical significance of the correlation between the volumes of goods sold in the metallurgical industry and mechanical engineering. As the relation exists, we can forecast the values of some data based on certain values of other data (metallurgy). To put it simply, the stronger the connection, the closer our prediction will be.

To build the model, we analyzed the financial status and profitability of PJSC "Zaporizhstal" and PJSC "Motor Sich" using eight ratios selected in the model. Financial analysis of PJSC "Zaporizhstal" showed that: the absolute liquidity ratio in 2013-2017 was less than the standard value and was 0.032; 0.021; 0.034; 0.06; 0.01, correspondingly, which indicates the irrational use of finances; solvency ratio (autonomy) of funds in 2013 increased from 0.432 to 0.499 in 2016, and then dropped to 0.423 in 2017, this indicator was close to the normal value only in 2016; the ratio of own working capital in 2013-2015 is below the standard, but in 2016-2017 the ratio was 0.209 and 0.18, which is higher than the standard value, which indicates the

company's financial instability in 2016-2017 and the inability to carry out active operation; the asset negotiability ratio in 2013-2017 was approximately the same at 0.97; 1.19; 1.188; 0.94; 0.91, respectively, which indicates the adequacy of current assets, since during the analyzed period there was a full cycle of manufacturing and circulation, as well as an equal ratio between revenues and the average annual amount of assets; the negotiability ratio of accounts payable in 2013-2017 amounted to 3.715; 3.24; 4.922; 3.703; 2.443 respectively, which indicates the use of creditors' funds as a source of financing for their debtors, and another part of the finances is used by the enterprise to finance business operations; the negotiability ratio of accounts receivable in 2013-2017 amounted to 9.656; 8.488; 5.696; 3.096; 2.023 respectively. That is, in 2017 compared to 2013, this indicator decreased by 4.8 times, which indicates an inefficient management of receivables in the enterprise; return on assets increased from 0.001 in 2013, 0.06 in 2014, 0.068 in 2015 to 0.133 in 2016, and in 2017 dropped to 0.07, which indicates a decrease in assets utilization efficiency; the return on equity ratio indicates that in 2014-2017, 0.13 UAH, 0.14 UAH, 0.26 UAH and 0.14 UAH of net profit were received for each attracted hryvnia of own funds.

The financial analysis of PJSC "Motor Sich" showed that: the absolute liquidity ratio in 2013-2017 was higher than the standard value and was 0.54; 0.377; 0.362; 0.616; 0.528 respectively, which indicates a rational use of funds; the solvency ratio (autonomy) in 2013-2017 was 0.7; 0.649; 0.686; 0.647; 0.663, respectively, which is higher than the standard value and shows a high level of solvency of the enterprise; the ratio of own working capital in 2013-2017 was 2.263; 1.816; 1.787; 2.871; 3.127 respectively, which is higher than the standard, and indicates the financial stability of the company and the ability to carry out vigorous activity; the assets negotiability ratio in 2013-2017 was 0.689; 0.721; 0.741; 0.461; 0.556, respectively, this indicates the insufficiency of current assets, since for the analyzed period there is an incomplete cycle of production and circulation; the negotiability ratio of accounts payable during 2013-2017 amounted to 24.062; 18.208; 9.802; 6.906; 15.155 respectively, which indicates the use of creditors' funds to finance business operations; the negotiability ratio of accounts receivable in 2013-2017 amounted to 5.829; 5.699; 6.128; 4.903; 4.69 correspondingly, which shows a slight decrease in the amount of receivables; the return on assets in 2013-2017 was 0.106; 0.105; 0.182; 0.086; 0.114, respectively, during the researched period, the above data are at approximately the same level, and indicate how much net profit was received for each hryvnia of assets invested; return on equity ratio in 2013-2017 was 0.154; 0.156; 0.272; 0.129; 0.174 respectively, and it shows how much net profit was received for each attracted hryvnia of own funds.

In our opinion, the assessment of economic security level should be based not only on indicators of financial condition, but also on an assessment of bankruptcy possibility of an enterprise, i.e. there is a correlation between these categories.

Modern scholars when conducting financial analysis widely use foreign approaches to predict the probability of bankruptcy of an industrial enterprise, namely the Altman model. From 2013 to 2017, the calculation results for the Altman model showed a low probability of bankruptcy at PJSC "Zaporizhstal", namely: 3.756; 4.071; 4.302; 4.712; 4.874, respectively, and at PJSC "Motor Sich", namely: 7.042; 6.829; 10.508; 5.321;

5.74 respectively, which is a consequence of the stable financial condition of enterprises (Table 4).

Table 4. Analysis of the likelihood of bankruptcy of large enterprises of the Zaporizhzhya region in 2013-2017 using the Altman model.

Year	Industrial enterprise	
	PJSC "Zaporizhstal"	PJSC "Motor Sich"
2013	3.756	7.042
2014	4.071	6.829
2015	4.302	10.508
2016	4.712	5.321
2017	4.874	5.740

The use of foreign models to define the probability of bankruptcy in Ukraine is not quite correct, since they are built on the experience of foreign companies. It is very different from the working conditions of domestic enterprises and the threshold values of the standard are defined on the basis of the past of foreign companies' activity.

Analysis of bankruptcy probability of twenty-nine Zaporizhzhya industrial enterprises for over 5 years using seven selected models of Altman, Springate, Taffler and Tishou, Saifulin-Kadykov, Lis, Conan, Golder and Beaver showed that using these models in practice gives the opposite results, namely, according to one model – a low probability, and to the other – a high probability of bankruptcy. Therefore, after analyzing the existing foreign models, we built our own improved model for estimating the probability of bankruptcy for Ukrainian companies, using data from their financial statements.

The problem of applying a larger period sample is complicated by the fact that in 2013 the National Regulation (Standard) of Accounting 1 "General Requirements for Financial Reporting" was approved with new forms of financial reporting. Financial statements of enterprises must be submitted to the state fiscal service before March 1 of a current year, and to statistics bodies – by February 28 of a present year, and put it in the official website until April 30, therefore the data range for analysis is selected from 2013 to 2017.

Most often, scientists suggest discriminatory models for evaluating the probability of bankruptcy for use in practice, but these models are not perfect for evaluating Ukrainian enterprises lately, since the correctness of their results depends on the period and year of the selected statements for financial analysis. Most of the models were derived earlier and they are not adapted to the financial reporting form, which was changed in 2013. We took the Saifulin-Kadykov approach as a basis, where the author chose 5 financial statements indicators, namely, the coefficients: providing with own funds, current liquidity, asset turnover, profitability of sales and equity.

According to the results of the analysis of the reporting of the studied industrial enterprises, we selected 8 significant indicators, in our opinion, that most characterize their financial condition. We selected several key indicators from each group that best reflect the real state of the company, namely the groups: liquidity, solvency, business activity and profitability. The main criterion for the selection of indicators was the

availability of different source data for their calculation in the financial statements of the company.

According to the results of the analysis of existing domestic and foreign models of bankruptcy probability in the context of these Zaporizhzhya regional industrial enterprises, the improved model is proposed, which is founded on the impact of the most valuable ratios of financial analysis and profitability. The resulting model for predicting the bankruptcy probability includes eight ratios of financial analysis and profitability, and has the following form:

$$Z=0.5x_1+0.3x_2+x_3+0.3x_4+0.01x_5+0.05x_6+0.3x_7+0.3x_8$$

where x_1 – the absolute liquidity ratio; x_2 – solvency ratio (autonomy); x_3 – the ratio of own working capital; x_4 – assets negotiability ratio; x_5 – negotiability ratio of accounts payable; x_6 – negotiability ratio of receivables; x_7 – asset profitability ratio; x_8 – ratio of return on equity.

Using discriminant analysis based on the results of practical data processing at twenty-nine industrial enterprises over the past five years, the coefficients to the selected eight indicators were determined using the SPSS Statistics system. On the basis of the obtained correlation coefficient between these indicators, it was established that there is a low relationship between them.

Approbation of the improved model made it possible to group the results of predicting the probability of bankruptcy in four ranges. The results of the model obtained and the boundaries of the range were verified with real data on the financial condition of enterprises.

In contrast to the existing models, in the bankruptcy probabilities evaluating scales with either two values (high and low) or three (high, medium or uncertain, and low), there defined four groups of values, namely: very low, low, possible and high bankruptcy probability. The resulting range of values is: if $x > 1.3$ – very low enterprise bankruptcy probability, if $0.6 < x < 1.3$ – low enterprise bankruptcy probability, if $0 < x < 0.6$ – possible enterprise bankruptcy probability, if $x < 0$ – high enterprise bankruptcy probability.

According to the results of the proposed model of bankruptcy in 2013-2017, PJSC “Motor Sich” was in the first group with a very low bankruptcy probability and in 2013-2017 PJSC “Zaporizhstal” fell into the second group with a low bankruptcy probability, which fully corresponds to the real data.

4 Conclusions

In this paper, the volume of sold industrial products (goods, services) was analyzed according to types of economic growth in Ukraine and Zaporizhzhya region, as well as two large industrial manufactures of Zaporizhzhya region. The evaluation of correlation link between values under analyses was conducted.

Based on the data of PJSC “Zaporizhstal” and PJSC “Motor Sich”, a financial analysis was conducted for the years 2013-2017. The Financial Report showed that in 2013-2017 PJSC “Zaporizhstal” sold its industrial products (goods, services) 3.4 times

more. PJSC “Motor Sich” production increased by 1.77 times. It was noted that the increase in sales volume of the analyzed industrial enterprises is more related to prices increase caused by inflation and the hryvnia exchange rate decline, and not to the real growth in the output volume.

According to the analysis of existing models of bankruptcy probability in the context of industrial enterprises of Ukraine, the authors proposed an improved assessing model based on the influence of the most significant ratios of financial analysis. Estimation of the main criteria for the quality of the model confirmed that the percentage of bankruptcies and stable activities foreseen are acceptable and indicate a high quality of the resulting equation. This will permit to use it in the diagnostic practice of the bankruptcy probability of industrial enterprises. Timely identification of problems will help to make management decisions on time, ensuring the stability of industrial enterprises that will impact the welfare of the area and Ukraine as a whole.

References

1. Andryushchenko, I.S.: Analiz sotsial'no-ekonomichnykh pokaznykiv rozvytku promyslovosti Ukrayiny (Analysis of socio-economic indicators of industrial development in Ukraine) *Naukovyy visnyk Mizhnarodnoho humanitarnoho universytetu. Seriya: Ekonomika i menedzhment.* **23**(1), 86–90 (2017).
2. Sitak, I.L., Korobkov, D.V., Mishchenko, V.A.: Sovremennyye metody opredeleniya ustoychivosti predpriyatiya (Modern methods for determining the sustainability of an enterprise). *Business Inform.* **9**, 92–98 (2012)
3. Vasin, S.M., Hamidullaeva, L.A., Finogeev, A.G., Mkrtychyan, V.S., Berezin, A.A., Palatkin, I.V.: Sotsial'nyye media kak indikator tsifrovoy aktivnosti i tsifrovoy zrelosti naseleniya (Social media as an indicator of digital activity and digital maturity of the population). *Problems of the modern economy.* **3**(67), 32–39 (2018)
4. Moschenok, V.V.: Ispol'zovaniye neyronnykh setey dlya modelirovaniya zavisimostey parametrov investitsionnykh proyektov (Using neural networks for modeling the dependencies of the parameters of investment projects). *Donetsk, Donetsk National Technical University,* 54–60 (2012)
5. Galushkin, A.I.: Gde primenyayut neyrokomp'yutery v finansovoy deyatelnosti (Where neurocomputers are used in financial activities). <https://neuronus.com/stat/175-primeneniya-nejrokomp'yutero-v-finansovoj-deyatelnosti.html> (2019). Accessed 21 Mar 2019
6. Khlystova, O.V.: Strategicheskoye upravleniye na osnove neyrosetevogo modelirovaniya (Strategic management based on neural network modeling). *Management in Russia and Abroad.* **3**, 18–24 (2011)
7. Mints, A.Yu., Bezzubkova, E.E.: Metody prognozirovaniya kolichestva bankrotstv v Ukraine (Methods for predicting the number of bankruptcies in Ukraine). *Economics and management organization.* **1**(17)/2(18), 174–181 (2014)
8. Veselý, A.: Economic classification and regression problems and neural networks. *Agric. Econ. Czech.* **57**, 150–157 (2011)
9. Abounoori, E., Bagherpour, M.: Estimation of industrial production costs, using regression analysis, neural networks or hybrid neural-regression method. *Iranian Economic Review.* **11**(2), 17–29 (2005)

10. Angelidis, D., Lyrودي, K., Koulakiotis, A.: Forecasting Daily Returns: A Comparison Of Neural Networks With Parametric Regression Analysis. *International Business & Economics Research Journal*. **5**(1), 75–82 (2006). doi:10.19030/iber.v5i1.3451
11. Barndorff-Nielsen, O.E., Shephard, N.: Econometric Analysis of Realised Covariation: High Frequency Covariance, Regression and Correlation in Financial Economics. *Econometrica*. **72**(3), 885–925 (2002). doi:10.2139/ssrn.305583
12. Khalikova, E., Lebert, T., Butusov, E.: Ispol'zovaniye instrumentariya matematicheskoy statistiki dlya prognozirovaniya investitsionnoinnovatsionnogo potentsiala Respubliki Bashkortostan (Using the tools of mathematical statistics to predict the investment and innovation potential of the Republic of Bashkortostan). *Economics and management*. **6**, 49–55 (2014)
13. Raevneva, E. V., Gorokhovaya, O. I.: Formirovaniye indikativnykh znacheniy pokazatelye raspoznavaniya klassa krizisa promyshlennykh predpriyatiy (Formation of indicative values of indicators of recognition of the crisis class of industrial enterprises). *Business Inform*. **7**(2), 21–23 (2011)
14. Ponomarenko, E.E.: Ispol'zovaniye nehotkikh mnozhestv pri otsenke finansovoy bezopasnosti sub'yektov khozyaystvovaniya promyshlennosti (The use of fuzzy sets in assessing the financial security of industrial entities). *Business Inform*. **9**, 109–113 (2012)
15. Altman, E. J.: Financial Ratios, Discriminant Analysis and the Prediction of Corporate Bankruptcy. *Journal of Finance*. **4**, 589–609 (1968)
16. Beaver, W.: Financial Ratios as Predictors of Failure. *Empirical Research in Accounting, Selected Studies. Journal of Accounting Research*. **4**, 71–111 (1966)
17. Toffler, R., Tishaw, H.: Going, going, gone – four factors which predict. *Accountancy*. **88**, 50–54 (1977)
18. Kondrashuhin, A., Pepa, T. & Fedorova, V.: Finansova sanatsia ta bankrutstvo pidpriemstv [Financial reorganization and enterprise bankruptcy]. Tsentri navchalnoi literatury, Kyiv (2007)
19. Gmurman, V.Ye.: Teoriya veroyatnostey i matematicheskaya statistika (Probability theory and mathematical statistics). Vysshaya shkola, Moscow (1972)
20. Melikhova, T., Makarenko, A., Mikhailytsa, O., Pozhuyev, A.: Improvement of bankruptcy probability model based on the analysis of industrial enterprises of Ukraine. *SHS Web of Conferences*. **65**, 06002 (2019). doi:10.1051/shsconf/20196506002

Prediction of Business Confidence Index Based on a System of Economic Indicators

Vita Los and Dmytro Ocheretin

Zaporizhzhia National University, 66, Zhukovskogo Str., Zaporizhzhia, 69600, Ukraine
vitalos.2704@gmail.com, odvisua@gmail.com

Abstract. One of the important indicators that characterize the economy of the country is the business confidence index. It is the basis for tracking the cycles of economic dynamics and analysis of the country's business climate. Evaluation of this indicator makes it possible to predict the crisis phenomena that are occurring in the economy, and to develop possible ways out of difficult situations. On the example of the five countries (Ukraine, Germany, Hungary, Slovenia, Poland) it was also analyzed the possibility of constructing the business confidence index based on economic indicators, which characterize current economic activity of the country. For analysis, the quarterly values of economic indicators over the last years were taken. The selected economic indicators based on cross-correlation analysis were ranked into three groups: coincident, lagging and leading indicators. Using coincident and leading economic indicators, the several regression models of the business confidence index were built. On the basis of the obtained regression models, the forecast of business confidence index value for the next period is evaluated and the trends of its development are established.

Keywords: business climate, business confidence index, cross-correlation analysis, socio-economic indicators.

1 Introduction

The modern development of the domestic economy is characterized by deepening international economic relations in connection with the intensification of European integration processes. This is the reason for the new tasks that confront the national economy and require solution and coordination with the world methodology of business management. One such task is the assessment and analysis of the country's business climate. The indicator characterizing the business climate in European countries is the index of business expectations, or as it is called the business confidence index (BCI) [1]. The business confidence index is a special economic indicator that reflects the state of the economy as a whole and in its individual sectors. This index is especially important for macroeconomics, as it characterizes the efficiency of economic activity and the prospects for the development of the country's economy as a whole. It is the basis for making economically sensible decisions about the effectiveness of identifying and using resources, and analyzes business cycles. This index is associated with the concept of economic cycles, because the economy develops unevenly and in its

dynamics can be traced to the presence of certain cycles. So on its basis it is possible to identify and predict the crisis phenomena that occur in the economy and to develop possible ways out of a difficult situation [2].

The purpose of this paper is to verify whether it is possible to use some of the economic indicators for calculating the business confidence index. Based on the selected methods we will try to confirm or reject the hypothesis which say that business confidence index can be predicted on the base of coincident indicators. The methodological basis for choosing economic indicators is the recommendations for calculating the business expectations indicators set out in the Joint Harmonised EU Programme of Business and Consumer Surveys, which contains the clear definition of the list of business expectations indicators and the methodology for their calculation [3].

Confidence indicators reflect entrepreneurs' perceptions and expectations at the sector level in the one-dimensional index. They are calculated as the simple arithmetic average of the balances of answers (in percentage points) to selected questions [4]. The respondents are asked to give their assessments of the current business situation and their expectations for the next six or twelve months. The situation can be characterised as “good”, “satisfactorily” or “poor”. The business expectations of the respondents for the next period are characterised as “more favourable”, “unchanged” or “more unfavourable”. The balance value of the current business situation is the difference of the percentages of the responses "good" and "poor", the balance value of the expectations is the difference of the responses "more favourable" and "more unfavourable" percentages. The business confidence index is a mean of the balances of the business situation and the expectations.

Ukrainian business confidence index is calculated since 2006 and consists of five averages of the balances in the industry, construction, retail and wholesale trade, agriculture, transport and some others (Figure 1).

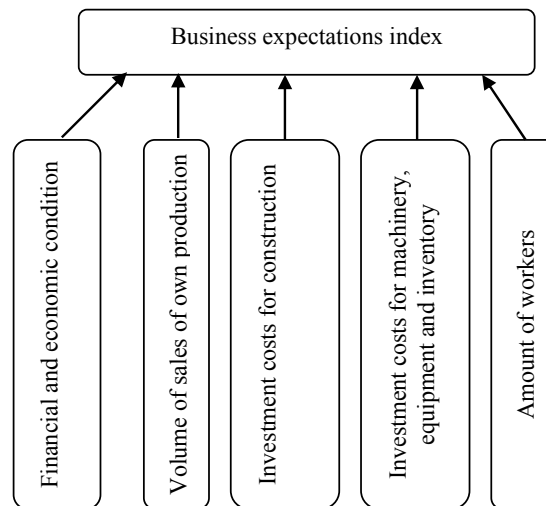

Fig. 1. The balances of business confidence index in Ukraine.

According to the method of the Organisation for Economic Co-operation and Development (OECD) composite confidence indicator (business confidence index) is average of the industrial confidence indicator (ICI), construction confidence indicator (CCI), retail trade confidence indicator (RCI) and confidence indicator for services (SCI) [5]. The industrial confidence indicator is an average of the balances to the questions in the industry survey relating to future tendency of production, total order books, stocks of finished goods. The construction confidence indicator is an average of the balances to the questions in the construction relating to total order books and future tendency of employment.

The retail trade confidence indicator is an average of the balances to the questions in the retail trade survey relating to present business situation, future tendency of the business situation and stocks. The confidence indicator for services is an average of the balances to the questions in the survey relating to the future tendency of employment, present business situation, future tendency of business situation.

2 Construction and Forecast of Business Confidence Index

Cross-correlation is a standard method of estimating the correlation degree of sequences [6]. The correlation coefficient r between the business confidence index (x_i) and economic indicator (y_i) with time delay t , where $i = 1, 2, \dots, N$ is considered. Time delay t and length of correlation series could be less than N , e.g., goal may be the verification of correlation for the limited set of measurements. Coefficient $r = 1$ lies in the range of $-1 \leq r \leq 1$ and the boundary values of this range point out to maximum correlation. When $r = 0$, correlation is absent. For the case of correlation coefficient equal to unity, there is a coincidence of the series and, accordingly, the maximum degree of correlation. When correlation coefficient is close to the unity in absolute value, but has a negative value, there is an inverse correlation, i.e., it is a contrary relationship between two variables such that they move in opposite directions.

In order to verify if a given economic indicator shown sufficient concurrence with business confidence index and does not behave as e.g. leading or lagging indicator, we will apply cross correlations for 12 periods forward and backwards. The first condition for including economic indicators in the groups of leading, coincident or lagging indicators is the highest absolute value of correlation coefficient must be at least 0.55 [7]. The second condition for including economic indicators contains the following:

1. coincident indicators have the highest absolute value of correlation coefficient in the period of time t ;
2. lagging indicators have the highest absolute value of correlation coefficient is on the right side from t ;
3. leading indicators have the highest absolute value of correlation coefficient is on the left side from t .

We have chosen the secondary data for our analysis, obtained from the National Bank of Ukraine [8], OECD [9] and CESifo Group Munich [10]. In all cases it was times series with quarterly periodicity.

To calculate the index of business expectations, we use the time series of economic indicators that correspond to the components of the index of business expectations. Based on the International System of Leading Indicators in the part of business tendency survey for analysis the following indicators were chosen: producer prices (index points), unemployment rate (% of labour force), Gross Domestic Product (annual growth rate), new orders (index points). The indicators used for the countries have been analyzed and time series are listed in Table 1.

Table 1. Economic indicators used for the analysis of business confidence index according to countries [11-15].

Countries	Time series (quarterly)	Economic indicators
Ukraine	2007-2018	– producer prices (index points), – unemployment rate (% of labour force), – Gross Domestic Product (annual growth rate)
Slovenia	2000-2018	– producer prices (index points), – unemployment rate (% of labour force), – Gross Domestic Product (annual growth rate)
Germany	2005-2018	– producer prices (index points), – unemployment rate (% of labour force), – Gross Domestic Product (annual growth rate), – new orders (index points)
Hungary	2001-2018	– producer prices (index points), – unemployment rate (% of labour force), – Gross Domestic Product (annual growth rate), – new orders (index points)
Poland	2006-2018	– producer prices (index points), – unemployment rate (% of labour force), – Gross Domestic Product (annual growth rate), – new orders (index points)

After the application of the selected methods, we got the result of cross correlations for all selected economic indicators for each country. Based on the results, we are able to assess, which indicators behave in line with the business confidence index and which act with a delay or in advance as compared to the business confidence and expectations.

Concerning Ukraine, we have the time series of the selected economic indicators and analyzed their in relation to business confidence index through cross correlations. The results of these correlations are compared in Table 2.

Table 2. Result of cross correlation between the business confidence index and economic indicators in 2007-2018 of Ukraine.

Economic indicators	Lag	Maximal absolute value of cross correlation
producer prices (index points)	$t - 12$	0.2119
unemployment rate (% of labour force)	$t - 1$	0.721
Gross Domestic Product (annual growth rate)	t	0.8657

The results of these correlations, with the range of 12 quarters forwards and backwards show that only two economic indicators act with business confidence index of Ukraine. The maximum value of cross correlation between producer prices and business confidence index were achieved in the period of time $t - 12$ and there absolute value were below 0.55 (0.2119). It means that this indicator does not show any relationship with any Ukrainian business confidence expectations. The result of the cross correlation between unemployment rate and business confidence index was achieved in the period of time $t - 1$ and there absolute values were above 0.55 (0.721). Consequently, unemployment rate is the leading indicator for business confidence index of Ukraine. The Gross Domestic Product (annual growth rate) is coincident indicator with business confidence index, because the highest absolute value of

correlation coefficient is in the period of time t and its meaning 0.8657. This economic indicator is a reflection of the financial and economic state of the country and is very important for the business community of each country.

We have also assessed the relation between the business confidence index and economic indicators of Germany. The results of these correlations are compared in Table 3.

Table 3. Result of cross correlation between the business confidence index and economic indicators in 2005-2018 of Germany.

Economic indicators	Lag	Maximum absolute value of cross correlation
producer prices (index points)	$t - 2$	0.4883
unemployment rate (% of labour force)	$t - 1$	0.503
Gross Domestic Product (annual growth rate)	t	0.7685
new orders (index points)	t	0.907

Cross correlations between producer prices and business confidence index and between unemployment rate and business confidence index do not show any relationship insofar as their maximum absolute value were below 0.55 (0.4883 and 0.503 respectively).

But, in the case of Germany we have found that 2 out of 4 tracked indicators report the maximum values of cross correlations above the level of 0.75 showing strong relationship of these indicators with the business confidence index. Such indicators are Gross Domestic Product and new orders. These indicators are coincident with the highest value of correlation coefficients in the period of time t (0.7685 and 0.907 respectively). We can recommend these indicators as an alternative to business confidence index, when it comes to monitoring economic tendency of Germany.

The next country for analysis is Hungary. The results of correlations for this country are compared in Table 4.

Table 4. Result of cross correlation between the business confidence index and economic indicators in 2001-2018 of Hungary.

Economic indicators	Lag	Maximum absolute value of cross correlation
producer prices (index points)	$t + 4$	0.360
unemployment rate (% of labour force)	$t - 2$	0.476
Gross Domestic Product (annual growth rate)	t	0.6181
new orders (index points)	$t + 1$	0.4297

Cross-correlation analysis revealed that three economic indicators do not affect the business confidence index of Hungary. The absolute value correlations of these economic indicators with business confidence index are below the threshold value of 0.55. They are equal 0.360, 0.476, 0.4297 for producer prices, unemployment rate and new orders respectively. Only Gross Domestic Product is coincidental indicator with

business confidence index; maximum absolute value of cross correlation is equal 0.6181.

We have also assessed the relation between the economic indicators and business confidence index of Slovenia. The results of these correlations are compared in Table 5.

Table 5. Result of cross correlation between the business confidence index and economic indicators in 2000-2018 of Slovenia.

Economic indicators	Lag	Maximum absolute value of cross correlation
producer prices (index points)	$t + 12$	0.1644
unemployment rate (% of labour force)	$t - 6$	0.415
Gross Domestic Product (annual growth rate)	$t - 1$	0.8425

Such economic indicators as producer price and unemployment rate are characterized by lack of relations with business confidence index of Slovenia. There maximum absolute value of cross correlations are 0.1644 and 0.415 respectively. The Gross Domestic Product is leading indicator of business confidence index with a lead of 1 quarter and maximum absolute value of cross correlation 0.8425.

The last monitored economy is Poland. The results of correlations for this country are compared in Table 6.

Table 6. Result of cross correlation between the business confidence index and economic indicators in 2006-2018 of Poland.

Economic indicators	Lag	Maximum absolute value of cross correlation
producer prices (index points)	$t + 12$	0.4894
unemployment rate (% of labour force)	$t + 11$	0.435
Gross Domestic Product (annual growth rate)	t	0.8794
new orders (index points)	$t + 1$	0.7012

Cross-correlation analysis revealed that two economic indicators do not affect the business confidence index of Poland. Such indicators as producer prices and unemployment rate have a maximum absolute value of cross correlation less than the threshold value (0.4894 and 0.435 respectively). The maximum absolute value of cross correlation between new orders and business confidence index is above the threshold value (0.7012), but this indicator is lagging with period of time $t + 1$. Therefore, this indicator is excluded from further consideration. The Gross Domestic Product is coincident indicator with the business confidence index with high level of correlation (0.8794).

The next step of business confidence index analysis is the construction regression model with coincident economic indicators and the forecast of the business confidence index for the next period. In order to forecast economic indicators for the next value in the next period of time it was used the single exponential smoothing with smoothing parameter α [16]. In this paper the smoothing parameter is $\alpha = 0.9$.

Investigate the applicability of linear and nonlinear (multiplicative) regression models for forecast of the business confidence index. Linear regression models are easiest to calibrate and are the most common. Some nonlinear regression models can be transformed to a linear model by means of some transformation such as logarithmization of dependent and independent variables. Predicted values can then be converted to ordinary numbers by taking their antilog or exponential [17]. Economic indicators are represented by percentage changes or index values changes. But some values of Gross Domestic Product (annual gross indicator) take negative values. Since the logarithmic function for negative values is not defined, the use of multiplicative models for forecast of the business confidence index is impossible. Therefore, for further research we will use the linear regression model which allow use of absolute and relative indicators that take both positive and negative values.

For Ukraine time series of data consists of 47 quarterly values (1st quarter 2007 – 3rd quarter 2018). The regression model of business confidence index of Ukraine is

$$BCI_{Ukraine} = 136,892 - 2,729 \cdot UR_{Ukraine} + 1,579 \cdot GDP_{Ukraine}, \quad (1)$$

where $BCI_{Ukraine}$ – business confidence index of Ukraine (index points);

$UR_{Ukraine}$ – Ukrainian unemployment rate (% of labour force);

$GDP_{Ukraine}$ – Gross Domestic Product (annual growth rate) of Ukraine.

The model is qualitative ($R^2 = 0.882$) and statistically significant ($F_{cal} = 197.9 > F_{table} = 3.2$ with 95% confidence that there is no significant difference in precision). The mean absolute percentage error (MAPE) of predicted values is 1.4%. Actual and predicted values of business confidence index of Ukraine is presented on Figure 2.

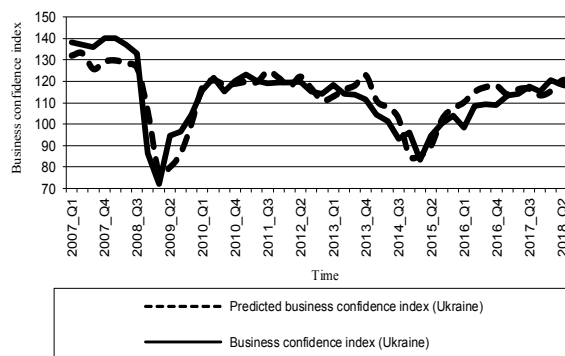

Fig. 2. Actual and predicted values of business confidence index of Ukraine in 2007-2018.

The forecast value of the business confidence index for the 4th quarter of 2018 is 119.5 and is in confidence interval [92.24; 146.77] with 95% confidence level. The forecast confirms the continued growth of business activity level in the economy of Ukraine.

For Germany time series of data consists of 56 quarterly values (the 1st quarter 2005 – the 4th quarter 2018). The regression model of business confidence index of Germany is

$$BCI_{Germany} = 57,33 + 0,69 \cdot GDP_{Germany} + 0,41 \cdot NO_{Germany}, \quad (2)$$

where $BCI_{Germany}$ – business confidence index of Germany (index points);
 $GDP_{Germany}$ – Gross Domestic Product (annual growth rate) of Germany;
 $NO_{Germany}$ – new orders (index points) of Germany.

The model is qualitative ($R^2 = 0.787$) and statistically significant ($F_{cal} = 81.4 > F_{table} = 3.2$ with 95% confidence that there is no significant difference in precision). The mean absolute percentage error (MAPE) of predicted values is 5.2%. Actual and predicted values of business confidence index of Germany are presented on Figure 3.

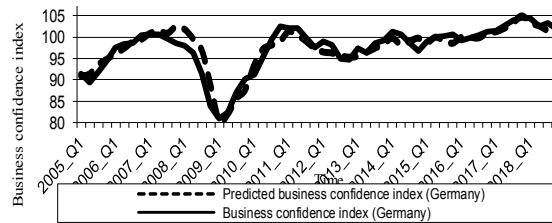

Fig. 3. Actual and predicted values of business confidence index of Germany in 2005-2018.

The forecast value of the business confidence index for the 1st quarter of 2019 is 101.4 and is in confidence interval [91.41; 111.41] with 95% confidence level. The forecast confirms the continuation of the fall in the level of business activity in the economy of Germany.

For the next country – Hungary – time series of data consists of 72 quarterly values (1st quarter 2001 – 4th quarter 2018). The regression model of business confidence index of Hungary is

$$BCI_{Hungary} = 99,19 + 0,31 \cdot GDP_{Hungary}, \quad (3)$$

where $BCI_{Hungary}$ – business confidence index of Hungary (index points);
 $GDP_{Hungary}$ – Gross Domestic Product (annual growth rate) of Hungary.

For the constructed model, the approximation accuracy is insufficient ($R^2 = 0.382$) and the model requires improvement. Actual values of business confidence index of Hungary are presented on Figure 4.

For the construction of the index of business expectations in Hungary required an additional analysis of indicators, that affect the expectations of the business environment.

For Slovenia time series of data consists of 76 quarterly values (1st quarter 2000 – 4th quarter 2018). The regression model of business confidence index of Slovenia is

$$BCI_{Slovenia} = 99,123 + 0,474 \cdot GDP_{Slovenia}, \quad (4)$$

where $BCI_{Slovenia}$ – business confidence index of Slovenia (index points);
 $GDP_{Slovenia}$ – Gross Domestic Product (annual growth rate) of Slovenia.

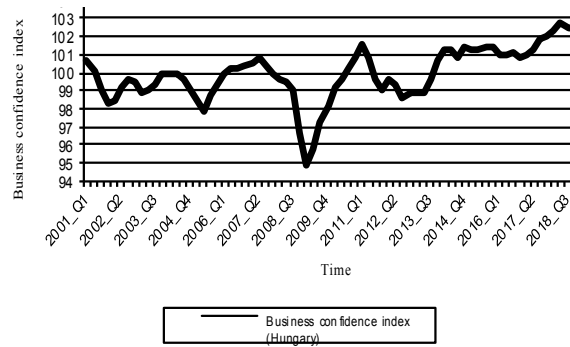

Fig. 4. Actual values of business confidence index of Hungary in 2001-2018.

The model is qualitative ($R^2 = 0.701$) and statistically significant ($F_{cal} = 173.4 > F_{table} = 3.97$ with 95% confidence that there is no significant difference in precision). The mean absolute percentage error (MAPE) of predicted values is 0.9%. Actual and predicted values of business confidence index of Slovenia presented on Figure 5.

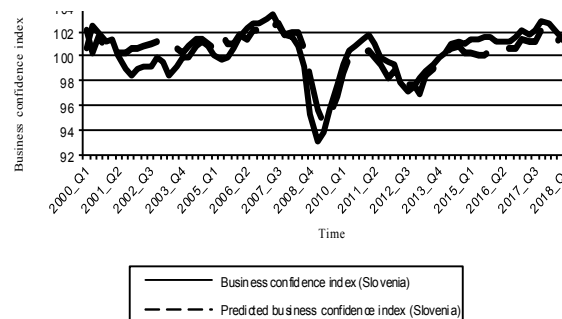

Fig. 5. Actual and predicted values of business confidence index of Slovenia in 2000-2018.

The forecast value of the business confidence index for the 1st quarter of 2019 is 101.1 and is in confidence interval [97.78; 104.43] with 95% confidence level. The forecast confirms the continuation of the fall in the level of business activity in the economy of Slovenia.

For Poland time series of data consists of 52 quarterly values (the 1st quarter 2006 – the 4th quarter 2018). The regression model of business confidence index of Poland is

$$BCI_{Poland} = 98,283 + 0,486 \cdot GDP_{Poland}, \quad (5)$$

where BCI_{Poland} – business confidence index of Poland (index points);

GDP_{Poland} – Gross Domestic Product (annual growth rate) of Poland.

The model is qualitative ($R^2 = 0.773$) and statistically significant ($F_{cal} = 170.7 > F_{table} = 4.03$ with 95% confidence that there is no significant difference in precision). The mean absolute percentage error (MAPE) of predicted values is 0.38%. Actual and predicted values of business confidence index of Poland are presented on Figure 6.

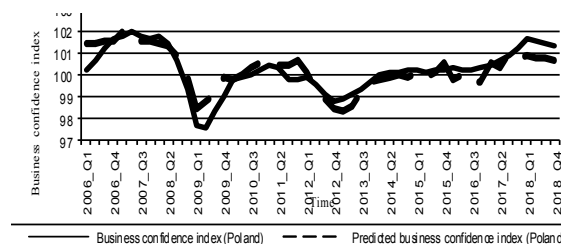

Fig. 6. Actual and predicted values of business confidence index of Poland in 2006-2018.

The forecast value of the business confidence index for the 1st quarter of 2019 is 100.7 and is in confidence interval [98.88; 102.48] with 95% confidence level. The forecast confirms the continuation of the fall in the level of business activity in the economy of Poland.

3 Conclusions

As mentioned above, generalized business confidence index is determined on the basis of the survey of respondents in a country regarding their business expectations. This assessment process is quite costly and problematic, as business entities may be more optimistic in their expectations during the survey. This, in turn, will lead to inaccurate information. Thus, the existing approach of determining the business confidence index is imperfect and requires clarification by formalizing the evaluation process. It can be carried out by means of the selection and justification of quantitative socio-economic indicators, on the basis of which the business confidence index will be determined. One more important condition is that the indicators belong to the group of leading, which would allow to establish and recognize crisis phenomena in the economy.

Finally, the business confidence index was improved, based on a system of socio-economic factors. The absolute value of correlation coefficient the indicators with the business confidence index must be the high. Also the indicators were grouped into three groups, and indicators that belonged to the group of coincident and the group of leading were chosen for estimation and forecasting.

The result of prediction of the business confidence index of Ukraine in the 4th quarter of 2018 will be equal to 119.5 and will increase by 1.97% from the 3rd quarter of 2018. This confirms the continuing optimism of respondents in Ukraine.

Predicted results for Germany, Slovenia and Poland show that the business confidence index for these countries in the 1st quarter of 2019 will decrease from the 4th quarter of 2018 by 0.57, 0.43 and 0.64 percent respectively. This is due to the uncertainty of business expectations in these countries.

For the prediction of the index of business expectations in Hungary the additional analysis is required. The results of cross-correlation and regression analyzes showed that Gross Domestic Product (annual growth rate) is not the main factor that influences business expectations in this country.

References

1. Gagea, M.: Confidence indicators analysis in the context of Romanian and European economy. *Procedia Soc Behav Sci.* **62**, 393–397 (2012)
2. Pronoza, P.: Theory and practice of early recognition of crisis processes in economy. *Innovatsiina ekonomika.* 51, 198–209 (2014)
3. European Commission: The Joint Harmonised EU Programme of Business and Consumer Surveys: User Guide. http://ec.europa.eu/economy_finance/db_indicators/surveys/documents/bcs_user_guide_en.pdf (2016). Accessed 21 Mar 2019
4. CESifo Group Munich: Calculating the ifo Business Climate. <http://www.cesifo-group.de/w/45YCTv5Bp> (2019). Accessed 18 Feb 2019
5. OECD: Business Tendency Surveys: A Handbook. <http://www.oecd.org/sdd/leading-indicators/31837055.pdf> (2003). Accessed 21 Mar 2019
6. Bourke, P.: Cross Correlation. <http://paulbourke.net/miscellaneous/correlate> (1996). Accessed 20 Feb 2019
7. Bilan, Y., Gavurova, B., Gedek, S., Tkacova, A.: The Composite Coincident Indicator (CCI) for business cycles. *Acta Polytechnica Hungarica.* **7(14)**, 71–90 (2017). doi:10.12700/APH.14.7.2017.7.5
8. National bank of Ukraine: Business expectations of enterprises. https://bank.gov.ua/control/uk/publish/category?cat_id=58374 (2019). Accessed 18 Feb 2019
9. OECD Data: Leading indicators – Business Confidence Index (BCI). <https://data.oecd.org/leadind/business-confidence-index-bci.htm> (2019). Accessed 18 Feb 2019
10. CESifo Group Munich: Long time-series for the ifo Business Climate. <http://www.cesifo-group.de/w/AABWVtCn> (2019). Accessed 18 Feb 2019
11. Tradingeconomics.com: Producer prices. <https://tradingeconomics.com/country-list/producer-prices> (2019). Accessed 18 Feb 2019
12. Unemployment – Unemployment rate. OECD Data. <https://data.oecd.org/unemp/unemployment-rate.htm> (2019). Accessed 18 Feb 2019
13. Tradingeconomics.com: Ukraine Unemployment Rate. <https://tradingeconomics.com/ukraine/unemployment-rate> (2019). Accessed 18 Feb 2019
14. Tradingeconomics.com: GDP annual growth rate. <https://tradingeconomics.com/country-list/gdp-annual-growth-rate> (2019). Accessed 18 Feb 2019
15. Tradingeconomics.com: New orders. <https://tradingeconomics.com/country-list/new-orders> (2019). Accessed 18 Feb 2019

16. Hyndman, R.J., Athanasopoulos, G.: Forecasting: principles and practice. OTexts, Melbourne (2013)
17. Gloudeans, R.J.: Comparison of three residential regression models: Additive, multiplicative, and nonlinear. *Assessment Journal*: **9**(4), 25–36 (2002)
18. Los, V., Ocheretin, D.: Construction of business confidence index based on a system of economic indicators. *SHS Web of Conferences*. **65**, 06003 (2019). doi:10.1051/shsconf/20196506003

Application of Fuzzy Logic Approach for the Determination of the Integral Index of the Implicit Impact of the Higher Education System on Regional Development

Oksana Sotula and Viktoriya Denysenko^[0000-0002-1029-1871]

Bohdan Khmelnytsky National University of Cherkasy, 81, Shevchenko Blvd., Cherkasy,
18031, Ukraine
{ksuna5, vikaonline}@ukr.net

Abstract. In this paper the theoretical and methodological aspects of the influence of the higher education system on the socio-economic development of the regions of Ukraine are considered. On the basis of fuzzy logic approach, we have calculated the integral index of the implicit impact ($III = I^4$) of the higher education system on regional development. Regions are grouped by this indicator over time. The integral indicator allowed us to identify regions with the corresponding I^4 of the higher education system at the regional level and compare them with other regions of Ukraine (identification of inter-regional imbalance). The analysis shows that there is no strategy for embedding the university in the local economy and society. It is impossible to state unequivocally that the most developed regions have the greatest influence on the system of higher education, and vice versa. An important continuation of the study should be an assessment of the situation in each region of the country separately. Such analytics should help develop differentiated directions for the development of regional higher education systems.

Keywords: fuzzy logic approach, implicit impact, higher education system, regional development, integral index, Mamdani inference.

1 Introduction

Over the past few decades, the evaluation of university contributions to the economic, social, cultural and innovative development of society has been central to educational policy issues. In higher education systems of economically developed countries, radical transformations are taking place that are associated with the increasing importance of universities for innovative development and economic growth. The two main objectives of each university are education and science. However, there is a growing awareness that universities are becoming enterprises with corresponding functions in the economy and society, except for school and laboratory. They begin to position themselves as engines of regional development. From the middle of the 20th century, the state policies

of developed countries are aimed at developing human capital, regional disparities of which may undermine national security.

The issue of the role of higher education institutions in stimulating the development of the regional economic system is being actively discussed in the scientific literature today. Thus, the studies of P. H. Pellenbarg [1], A. Valero, and J.V. Reenen [2] are devoted to the calculation of the quantitative contribution of universities to regional development.

G. Huggins, P. Cook, D. Charles, P. Benneworth, G. Etzkowitz, D. Bock, etc. [3] evaluate the contribution of universities to the innovative development of regions, analyze how universities can produce not only new knowledge and technologies, but also implement them in regional socio-economic and production systems [4].

Eliot, Levin and Mazil consider universities as generators of economic development of the region at the expense of funds invested in education in the form of state financing, tuition fees and living expenses for students from other regions, industrial orders [5].

The aforementioned approach expanded B. Bluestone [6] by adding to the criteria for assessing the impact of higher education on the regional economy an assessment of the level of qualifications of workers. According to this approach, universities train and produce more skilled workers who have higher labor productivity, higher levels of income and consumption, and therefore, provide higher tax deductions to the budget.

However, the methodology for assessing the integrated impact of the higher education system on regional development is insufficiently developed.

Therefore, the aim of the article is to study the implicit impact of the higher education system on the socio-economic development of the region. This will provide an opportunity to develop practical mechanisms for ensuring balanced regional development.

To achieve this goal, we use the following methods: theoretical generalization, comparison and systematization (in the study of the nature and effects of the impact of the higher education system on the development of regions). Abstract-logical method (for theoretical generalization), the index method in context with the mathematical apparatus of the theory of fuzzy sets (for determining the integral index of the implicit impact of the higher education system on regional development), the graphical method (for visualizing the relationship between input and output variables).

2 Results

The influence of the higher education system on the socio-economic development of the region is increasingly becoming the center of research for domestic and foreign scientists. Reality indicates a change in the socio-economic goals of the university. From its first generation (educational institution only), to the second generation university (training and research), and the third generation university (integrated educational, research and business environment).

Today we are talking about fourth-generation universities. Its exact characteristics are still insufficiently investigated. The essential difference of such a university is the

availability of a strategic approach to its own development and the ability to actively influence the competitiveness of the regional environment [7].

We believe that the growth of influence on regional development can be expected already from third-generation universities, because it is here that not only education and research, but also the use of knowledge become important. As a result, the relationship between production and universities is deepening, so there is the possibility of local use of knowledge created in universities. This increases the competitiveness of enterprises and, as a result, the region. In addition, the social environment of universities is improving. A knowledge-based society is inevitably linked to the valuation of human capital, since the competitiveness of an economy depends on the quantity and quality of available human resources.

There are several classifications of areas and types of university influence on the regional system. According to R. Florax, there are eight regional effects of university activities in the demographic subsystem, economic subsystem, infrastructure, culture, attractiveness of the region, education, social subsystem, political subsystem [1].

There are short-term and long-term impacts of universities on the region's economy. In the short term, there is an impact on the demand of local enterprises, the income and expenses of local households, and the services and income of local governments. The long-term impact on the university is the qualification of human capital, attracting foreign capital and labor in the immediate vicinity of the university and the number of enterprises based on university research. These factors can be considered as having a secondary regional multiplicative effect, since they heighten the demand for local goods and services [8].

Regional and local effects of the university can be observed in many areas outside the economy. As a rule, three types of economic influence of universities are evaluated in research: direct, indirect, and induced [9].

In our opinion, the most comprehensive by the nature of the impact of the classification of the results of university activities should take into account the type of impact on the regional subsystem (Table 1).

Table 1. Types of university influence on regional subsystems.

Regional subsystems	Types of university influence			
	Direct	Indirect	Induced	Catalytic
Demographic	√	√	√	√
Economic	√	√	√	√
Infrastructure	√	√	√	√
Culture	√	√	√	√
Attractiveness				√
Education	√	√	√	√
Social				√
Political				√

It is clear that the selected areas are not isolated from each other but have different effects. The most significant activity of the university affects the economic subsystem, which is closely linked to the demographic changes, infrastructure, educational system and image of the region.

The economic impact of a higher educational establishment is defined as the difference between the existing level of economic activity in the region and the level that could have been if the institution did not exist [10].

However, the quantitative assessment of the impact of universities on the regional subsystem is complicated by the presence of the implicit impact of the higher education system on regional development.

Implicit mechanisms are based on mechanisms of different order. Its characteristics are manifested in human activity in different ways. In psychology, it is associated with the implicit personality theory, which allows you to form a holistic impression of another person based on incomplete information about his personal characteristics. Mathematicians and other representatives of the exact sciences are concentrating their efforts in developing data search and recovery algorithms based on implicit factors that influence various processes. In economics, the term “implicit” is associated mainly with “intangible”, “immeasurable”, “elusive” factors that affect the economic activity of an economic agent. Thus, implicit factors are implicit, hidden factors, production resources, which in the course of economic activity do not find direct, official reflection [11].

Implicit impact (the influence of implicit factors) is an implicit influence within the economic system that can lead to a synergistic effect. This effect is that when the subject achieves significant economic results, an area of unstable conditions arises. A minor hidden influence of external forces can lead to diametrically opposite development vectors: from the collapse of the system to a new, higher level of development. The nature of implicitness lies in the presence of hidden (implicit) information that circulates in the economic environment and requires decision-making after in-depth analysis of data in order to obtain the most complete information. In our case, implicitness is understood as the impossibility to take into account all aspects of the impact under study, since in the process of analysis, hidden, implicit, unaccounted information appears in the data-information-knowledge chain.

In our opinion, the urgent task is to construct an integral index of the implicit impact ($III = I^4$) of the higher education system on regional development and to group the regions according to this indicator.

To construct the integral index, we used the index method in context with the mathematical apparatus of the theory of fuzzy sets (fuzzy logic and Mamdani fuzzy logical inference) [12], which allows to use of heterogeneous input variables, formalize nonlinear dependencies, use natural language to describe the connection, and obtain fuzzy models that are flexible for tuning and adaptation. The main stages of constructing a Mamdani fuzzy logical inference are as follows:

1. determination of the main factors (parameters) of the system under consideration;
2. determination and formalization of linguistic variables (fuzzification);
3. the construction of a fuzzy knowledge base (fuzzy production rules);
4. implementation of a fuzzy inference;
5. reducing the fuzzy value of the output variable into a clear one using the center of gravity method (defuzzification).

Note that the index method of determining the integral index involves the following steps:

1. the choice of indicators characterizing the phenomenon;
2. statistical analysis and standardization (normalization) of data;
3. the calculation of the partial indices (sub-indices);
4. determination of the resulting integral index on the basis of sub-indices;
5. analysis and interpretation of the result.

In our study, the main blocks (sub-indices) of the I^4 of the higher education system in the socio-economic development of the regions are economic, innovative, educational and demographic (see Table 2).

Each of these partial indices will be determined using three indicators (stimulators). According to the classical scheme, the aggregate index consists of partial indices and is represented in the form of their weighted sum or product. The selection of indicators for the evaluation of each of the blocks is based on the presented theoretical approaches, but takes into account the features of the domestic system of higher education and the factors associated with the characteristics of data collection.

It should be noted that the procedure for determining the weight coefficients of the components of the general index is labor intensive, since it is necessary to take into account considerable achievements in this sphere and cover a large number of judgments, even often incomparable. But using the methods of the theory of fuzzy sets allows us to avoid these difficulties in determining weight coefficients.

For calculations, only the normalized (standardized) values of the parameters belonging to the segment $[0, 1]$ are used. The process of normalization of indicators is carried out according to the formula:

$$z_i = (X_i - X_{\min}) / (X_{\max} - X_{\min}) - \text{normalized values of the indicator in the } i\text{-th region.}$$

The main idea of obtaining a resulting index is as follows.

1. Each sub-index is considered as the output variable in the Mamdani algorithm, and the corresponding indicators that characterize this partial index are used as input linguistic variables, moreover all input and output variables containing three terms: L (low), M (medium), H (high).
2. The general index (I^4) is considered as the output variable in the Mamdani algorithm, and the sub-indices that characterize this general index (and found in the previous step) are already used as input linguistic variables (Figure 1), moreover all the input variables containing three terms: L (low), M (medium), H (high), and the output variable – L (low), BM (below medium), M (medium), AM (above medium), H (high).

The procedure for finding sub-indices and the overall integral indicator is conducted for a specific year for all regions of Ukraine and their grouping is performed according to this indicator. Each term corresponds to a fuzzy set, which is given by the corresponding membership function. The specific form of membership functions is determined on the basis of various additional assumptions about the properties of these functions, taking into account the specificity of the existing uncertainty and the actual

situation, expert data, etc. For our fuzzy model of determining the integral index we use the trapezoidal membership functions (Fig. 1). Formalized representations of input and output variables are obtained by means of Matlab fuzzy logic toolbox [13].

Table 2. The list of indicators characterizing sub-indices.

Sub-indices	Indicators (stimulators)	Economic contribution of the university	Regional effect
Economic (I_1)	X_1 – GRP per capita, UAH.	Impact on the regional economy, budget revenues, industrial structure, labor market, labor mobility	Wages, purchase of equipment, goods and services (direct). Income and expenditures of participants in university supply chains (indirect). Income and employment are caused by the multiplicative effect of income and expenditures of employees, both of the university and its associated companies (induced).
	X_2 – GRP per worker of working age, UAH.	Impact on the level of education, structure and quality of labor in the region	Providing the labor market with highly skilled labor, the growth of labor productivity in the region (catalytic).
	X_3 – Small and medium business (SME) per 10 thousand population, units.	Companies that are created by students (former) and university staff	Income and employment in companies that are formed thanks to the university (catalytic).
Innovative (I_2)	X_1 – Distribution of applications for inventions and utility models addressed to national applicants by region.	Selling knowledge in the form of patents, regional value added in the field of information technology	Income from research activities (direct).
	X_2 – Regional gross value added in the field of information and telecommunications (IT companies) (UAH per capita).		Jobs created by the functioning of the university (direct). Income and employment are caused by the multiplicative effect of income and expenditures of employees in the IT sector (induced).
	X_3 – Organizations that carried out research and development, per 10 thousand population, units.		Government funding, business income, income and employment in organizations that carry out research and development (catalytic).
Educational and demographic (I_3)	X_1 – Economically active population aged 15-70 years, number of people by level of education per 10 thousand population.	The impact on the level, structure and quality of education in the region. Population growth, changing population structure and mobility.	Providing the labor market with highly skilled labor, flexible supply of student labor (induced).
	X_2 – Number of institutions of higher education per 10 thousand population.		Provision of educational services (direct). Income and expenditures of employees of the university and related institutions (indirect). Income and employment caused by the multiplicative effect of income

Sub-indices	Indicators (stimulators)	Economic contribution of the university	Regional effect
			and expenditures of employees (induced).
	X_3 – Number of students, per 10 thousand population.		Expenditures for the purchase of goods and services, tuition fees (direct). Increase in labor force (induced).

Then the structural identification of the model is carried out with the help of forming a fuzzy base of the production rules «IF-THEN» that reflect the connection of the «input-output».

The set of fuzzy production rules for the given knowledge base has the form:

IF $(I_1=L)$ and $(I_2=L)$ and $(I_3=L)$ or ... or $(I_1=L)$ and $(I_2=L)$ and $(I_3=M)$, THEN $I=L$;

IF ..., THEN ...;

IF $(I_1=M)$ and $(I_2=H)$ and $(I_3=H)$ or ... or $(I_1=H)$ and $(I_2=H)$ and $(I_3=L)$, THEN $I=AM$.

A fuzzy logical inference is implemented, ranging from logical statements to fuzzy logic equations. Such equations are derived from the knowledge base by replacing the linguistic terms to the membership function, and the operations «and» and «or» to the operation of finding the minimum (\wedge) and the maximum (\vee) respectively, while the weight of rule is taken into account by multiplying the fuzzy expression by the corresponding value of weight:

$$\mu^{b_j}(x_1, \dots, x_n) = \bigvee_{p=1, k_j} w^{jp} \cdot \bigwedge_{i=1, n} \mu^{ip}(x_i),$$

where b_j is the j -th term of output linguistic variable.

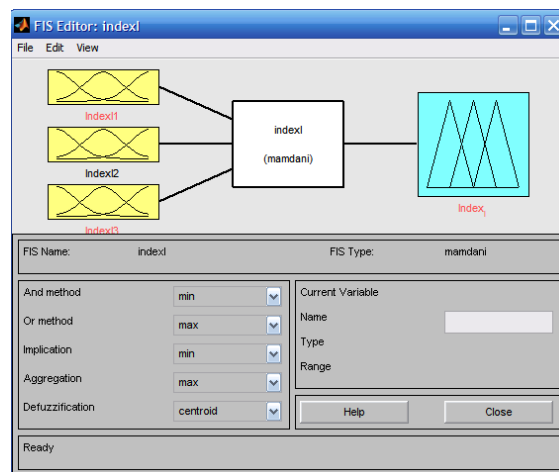

Fig. 1. Scheme of Mamdani fuzzy logical inference for the general integral index.

The system of fuzzy logic equations has the form:

$$\begin{aligned} \mu^L(I_1, I_2, I_3) &= (\mu^L(I_1) \wedge \mu^L(I_2) \wedge \mu^L(I_3)) \vee \dots \vee (\mu^L(I_1) \wedge \mu^L(I_2) \wedge \mu^M(I_3)); \\ &\dots \\ \mu^{AM}(I_1, I_2, I_3) &= (\mu^M(I_1) \wedge \mu^H(I_2) \wedge \mu^H(I_3)) \vee \dots \vee (\mu^H(I_1) \wedge \mu^H(I_2) \wedge \mu^L(I_3)). \end{aligned}$$

The final fuzzy set \tilde{I} is obtained as the union of all trimmed fuzzy subsets for each fuzzy rule:

$$\tilde{I} = \bigcup_{j=1}^5 \frac{\min(\mu^{b_j}(I_1, I_2, I_3), \mu^{b_j}(I))}{I}.$$

Next, the fuzzy result is defuzzified by the method of the center of gravity, after which we obtain a clear value of the I^4 at the regional level

$$I = \frac{\int_0^1 y \cdot \mu^{\tilde{I}}(y) dy}{\int_0^1 \mu^{\tilde{I}}(y) dy}.$$

Thus, on the basis of the indicated formulas and the methodology of fuzzy logic inference, we can obtain the value of the integral index for each region in the dynamics. To facilitate calculations, all phases of fuzzy simulation is performed by means of the Matlab fuzzy logic toolbox. After adjusting the parameters of the membership functions of the terms of input and output linguistic variables, the fuzzy knowledge base is filled. A visual presentation of the procedure of the fuzzy logic inference of Mamdani type and the defuzzification of the integral index is shown in Figure 2.

In the Figure 3 the visualization of the surfaces of the dependencies of the output linguistic variable from the other two input variables is presented.

As a result of the assessment, we obtained three sub-indexes of the higher education system: a contribution to the economic development of the region, a contribution to the innovative development of the region, and a contribution to the educational and demographic development of the region. The results of calculations for each of the sub-indices are presented in Table 3.

As you can see, the value of sub-index ranges from 0 – the worst, to 1 – the best value in the country. This allows us to represent all the regions of Ukraine in the order of the degree of their development for each of the sub-indices. At the same time, the place of the region in the uniform scale for Ukraine and the change in its potential is important. This makes it possible to consider changes in the integral index in a regional context and analyze the trends of each specific region.

The leaders in the sub-index of influence on economic development are Kiev, Poltava, Dnipropetrovsk and Zaporizhzhia regions. The presence of large universities in these regions explains the relatively high rates of income of universities.

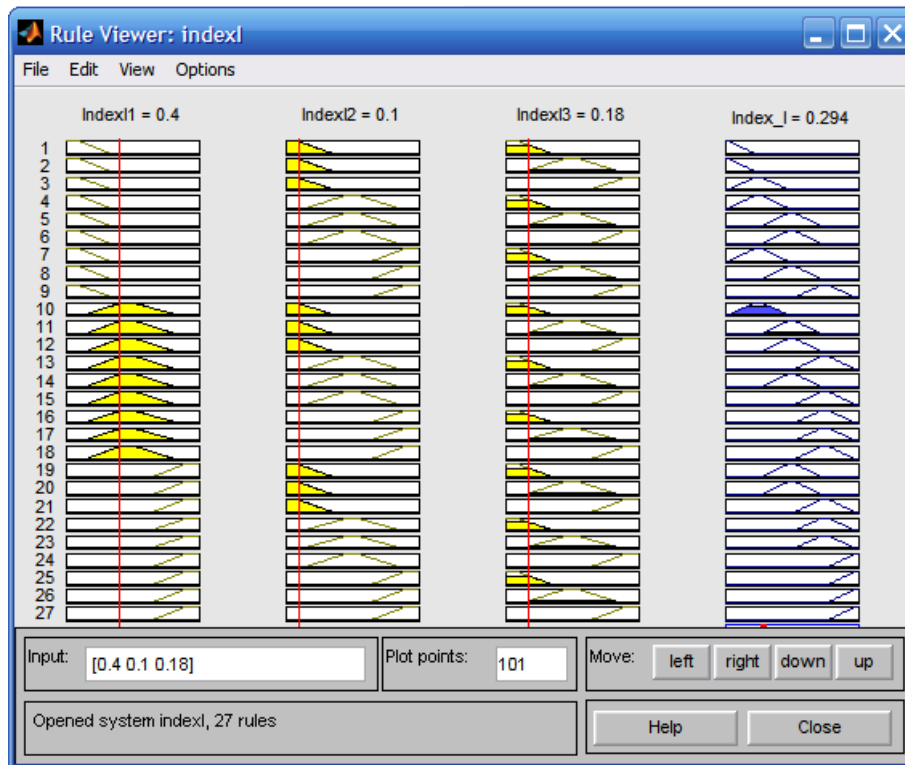
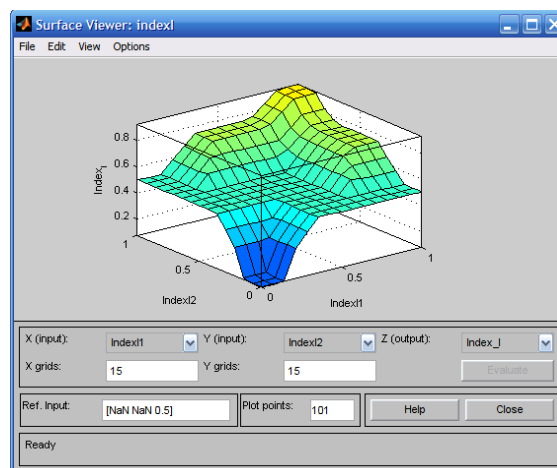
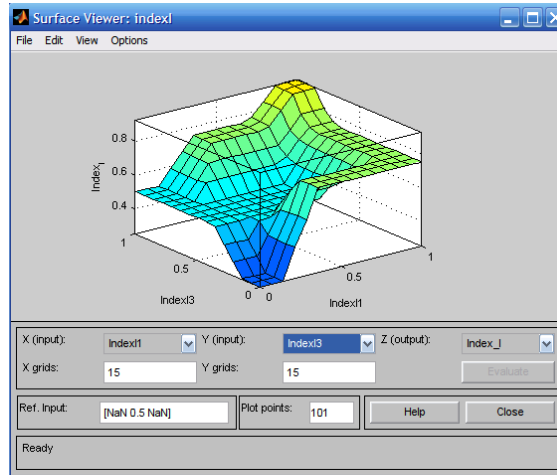

Fig. 2. Procedure for the fuzzy logic inference of Mamdani type (Zaporizhzhia region, 2016) $X = [0.4; 0.1; 0.18]$.



The surface of the dependence of the output of the fuzzy system I on the input variables I_1 and I_2 .



The surface of the dependence of the output of the fuzzy system I on the input variables I_1 and I_3 .

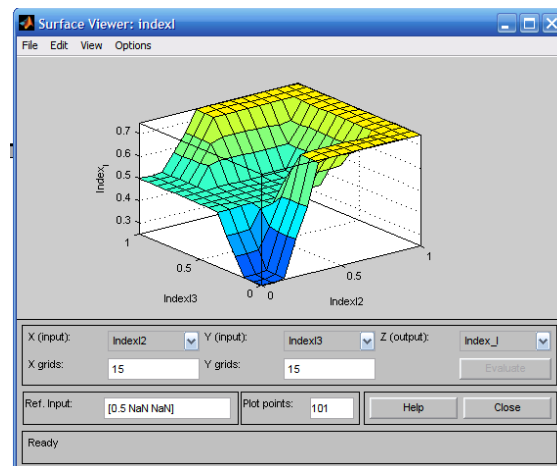

The surface of the dependence of the output of the fuzzy system I on the input variables I_2 and I_3 .

Fig. 3. Surfaces of the dependence of the output of the fuzzy system on the input variables.

On the second sub-index, besides Kiev, another region is leading – Kharkiv region. Here are located large national universities, which constitute a significant part of the regional innovation infrastructure.

The largest share of applications for inventions and utility models falls on the «Science» and «Education» sectors. Moreover, the number of applications submitted by educational institutions annually exceeds the number of applications submitted by scientific organizations. In 2016, the applicants of the Ministry of Education and

Science of Ukraine submitted 2849 applications (this represents 37.9% of the total number of applications filed).

Table 3. Calculated values of the sub-indices and the integral index of the regions of Ukraine (2012/2016).

Region	Sub-index I_1		Sub-index I_2		Sub-index I_3		Integral index I	
	of the year		of the year		of the year		of the year	
	2012	2016	2012	2016	2012	2016	2012	2016
Vinnitsia	0.08	0.20	0.09	0.10	0.08	0.09	0.07	0.15
Volyn	0.07	0.08	0.07	0.07	0.08	0.08	0.07	0.07
Dnipropetrovsk	0.49	0.48	0.29	0.22	0.49	0.49	0.50	0.50
Donetsk	0.45	0.09	0.23	0.08	0.50	0.13	0.50	0.08
Zhytomyr	0.07	0.08	0.08	0.07	0.08	0.08	0.07	0.07
Zakarpattia	0.07	0.08	0.08	0.07	0.08	0.08	0.07	0.07
Zaporizhzhia	0.29	0.40	0.09	0.10	0.18	0.18	0.29	0.29
Ivano-Frankivsk	0.08	0.08	0.08	0.08	0.08	0.08	0.07	0.07
Kiev	0.46	0.48	0.09	0.09	0.09	0.10	0.25	0.25
Kirovohrad	0.08	0.22	0.08	0.08	0.08	0.08	0.07	0.12
Luhansk	0.09	0.07	0.10	0.08	0.27	0.07	0.09	0.07
Lviv	0.08	0.28	0.15	0.17	0.39	0.47	0.13	0.41
Mykolaiv	0.08	0.12	0.09	0.08	0.08	0.08	0.07	0.09
Odessa	0.18	0.33	0.10	0.09	0.35	0.43	0.23	0.48
Poltava	0.44	0.50	0.08	0.08	0.09	0.08	0.21	0.25
Rivne	0.07	0.08	0.07	0.07	0.08	0.08	0.07	0.07
Sumy	0.08	0.08	0.07	0.07	0.08	0.08	0.07	0.07
Ternopil	0.07	0.08	0.07	0.07	0.08	0.08	0.07	0.07
Kharkiv	0.33	0.39	0.49	0.50	0.49	0.50	0.50	0.51
Kherson	0.08	0.09	0.08	0.08	0.08	0.08	0.07	0.08
Khmelnitskyi	0.07	0.08	0.07	0.07	0.08	0.08	0.07	0.07
Cherkasy	0.08	0.24	0.08	0.08	0.08	0.08	0.07	0.20
Chernivtsi	0.07	0.08	0.08	0.08	0.08	0.08	0.07	0.07
Chernihiv	0.08	0.09	0.07	0.07	0.08	0.08	0.07	0.07
city Kiev	0.95	0.95	0.95	0.95	0.95	0.95	0.94	0.94

The most active among the organizations of the Ministry of Education and Science of Ukraine were institutions of higher education in the city of Kiev and the Kharkov region: National University of Food Technologies (10.3% of the total number of applications filed by applicants from this ministry) National Technical University of Ukraine «Kiev Polytechnic Institute» (7.8%), National Aerospace University. M.E. Zhukovsky Kharkiv Aviation Institute (4.3%), Kiev National University of Technology and Design and Vinnitsa National Technical University – 117 and 116 applications, respectively (4.1%), National Technical University Kharkiv Polytechnic Institute – 91 applications (3.2%), Odessa National Academy of Food Technologies – 83 applications (2.9%) [14].

The leaders in the framework of I^4 on the higher education system for regional development are Kiev, Dnipropetrovsk, Lviv, Kharkiv and Odessa regions. These are

regions with large university centers. Here the number of universities is 45.8% of the total in Ukraine (259 institutions out of 657).

The leaders in the contribution of higher educational institutions to the educational and demographic development of the region are Kiev, Kharkiv, Odessa, Lviv and Dnipropetrovsk regions.

According to the research of the CEDOS analytical center “Movement of applicants between the regions of Ukraine” in 2017 and 2018, only Kharkov, Kiev, Odessa, Lviv and Chernivtsi regions had a positive balance of arrival and departure. In other regions there was an outflow of graduates [15].

The results of the sub-indices of the regions of Ukraine for 2012 and 2016 have been summarized in the integral indicator of the implicit impact of the higher education system on regional development (see Table 3). Based on the data in Table 3 we have conducted a grouping of regions according to the I^4 of the higher education system at the regional level, the results of which are given in Table 4.

Table 4. Grouping of Ukrainian regions by I^4 , 2012/2016.

Year	The boundaries of the integral indicator	The meaning of the integral indicator	Distribution of regions by integral indicator
2012	[0;0.1)	critically low	Vinnitsia. Volyn. Zhytomyr. Zakarpattia. Ivano-Frankivsk. Kirovohrad. Luhansk. Mykolaiv. Rivne. Sumy. Ternopil. Kherson. Khmelnytskyi. Chernivtsi. Cherkasy. Chernihiv
	[0.1;0.2)	low	Lviv
	[0.2;0.4)	below the average	Zaporizhzhia. Kiev. Odessa. Poltava
	[0.4;0.6)	average	Dnipropetrovsk. Donetsk. Kharkiv
	[0.6;0.8)	above the average	–
	[0.8;1]	tall	city Kiev
2016	[0;0.1)	critically low	Volyn. Donetsk. Zhytomyr. Zakarpattia. Ivano-Frankivsk. Luhansk. Mykolaiv. Rivne. Sumy. Ternopil. Kherson. Khmelnytskyi. Chernivtsi. Cherkasy. Chernihiv
	[0.1;0.2)	low	Vinnitsia. Kirovohrad
	[0.2;0.4)	below the average	Zaporizhzhia. Kiev. Poltava. Cherkasy
	[0.4;0.6)	average	Dnipropetrovsk. Lviv. Odessa. Kharkiv
	[0.6;0.8)	above the average	–
	[0.8;1]	tall	city Kiev

Most regions of Ukraine have integral indicator values that are critically low, low, and below average. In addition, the belonging of regions to one or another group of indicators practically did not change in 2016 compared to 2012. Growth rates are observed in Vinnitsia (2.14), Kirovograd (1.71), Lviv (3.15), Nikolaev (1.29), Odessa (2.09), Poltava (1.19), Kharkiv (1.02), Kherson (1.14), Cherkasy (2.86) regions. The integral indicator decreased in Donetsk (0.16) and Luhansk (0.78) regions. But this is

due primarily to the unfavorable situation in the East of Ukraine and the neglect in the statistical data of a part of the occupied territories. In the remaining regions, the integral index remained almost unchanged. The current situation indicates that there is no effective strategy of «embedding» universities in the local economy and society at both the national and regional levels.

3 Conclusions

The analysis suggests that there is no direct link between the sub-indices and the level of development of the regions. It is impossible to state unequivocally that the higher education system has the greatest influence on the most developed regions, and vice versa. The results obtained allow us to conclude that the degree of influence of the higher education system on regional development is a complex characteristic.

The obtained integral indicator allows only to single out regions with one I^4 of the higher education system in comparison with others (identification of interregional imbalance). Even high values of the indicator do not mean that regional universities begin to play the role of centers of education and culture, or in general determine the level of the region.

An important continuation of the study should be an assessment of the situation in each region of the country separately. Such analytics will be able to provide indispensable assistance in determining the differentiated directions for the development of regional systems of higher education. Such systems should be focused on maximally promoting the development of territories, taking into account their specifics.

It is worth noting that the fuzzy model we have developed for determining the I^4 can be refined and adapted to new data. Some input variables may be entered new or removed. One can extend the range of terms of linguistic variables etc. That is, the constructed model is flexible in setting and changing parameters. It does not require complex mathematical calculations (due to the use of Matlab).

References

1. Pellenbarg, P.H.: How to calculate the impact of a university on the regional economy. A case study of the University of Groningen, the Netherlands. <http://www.rug.nl/staff/p.h.pellenbarg/artikelen/publicaties/13.%20how%20to%20calculate%20the%20impact%20of%20a%20university%20on%20the%20regional%20economy.pdf> (2007). Accessed 18 Jan 2019
2. Valero, A., Reenen, J.V.: The economic impact of universities: evidence from across the globe. https://www.lampadia.com/assets/uploads_documentos/95d91-valeromimeo2016.pdf (2016). Accessed 08 Jan 2019
3. Huggins, R., Johnston, A.: The economic and innovation contribution of universities: a regional perspective. *Environ. Plann. C: Gov. Policy*. **27**(6), 1088–1106 (2009).
4. Benneworth, P., Charles, D.: University spin-off policies and economic development in less successful regions: Learning from two decades of policy practice. *Eur. Plan. Stud.* **13**(4), 537–557 (2005). doi:10.1080/09654310500107175

5. Elliott, D.S., Levin, S.L., Meisel, J.B.: Measuring the economic impact of institutions of higher education. *Res. High Educ.* **28**(1), 17–33 (1988). doi:10.1007/BF00976857
6. Bluestone, B.: UMASS/Boston: An Economic Impact Analysis. <https://files.eric.ed.gov/fulltext/ED356733.pdf> (1993). Accessed 03 Jan 2019
7. Zuti, B., Lukovics, M.: “Fourth generation” universities and regional development. https://mpira.uni-muenchen.de/77460/1/MPRA_paper_77460.pdf (2015). Accessed 03 Jan 2019
8. Lukovics, M., Zuti, B.: New functions of universities in century XXI towards “fourth generation” universities. *J. Transit. Stud. Rev.* **22**(2), 33–48 (2015). doi:10.14665/1614-4007-22-2-003
9. Rol universytetiv v ekonomichnomu rozvytku mist, rehioniv, krainy (The role of universities in the economic development of cities, regions, and countries). https://www.csr-ukraine.org/wp-content/uploads/2015/12/forum_publ_all_bezpolos_print.pdf (2015). Accessed 24 Dec 2018
10. Kotosz, B., Gaunard-Anderson, M-F., Lukovics, M.: The local economic impact of universities: an international comparative analysis. https://www.researchgate.net/publication/289520733_The_Local_Economic_Impact_of_Universities_An_International_Comparative_Analysis (2015). Accessed 14 Jan 2019
11. Rayzberg, B.A.: *Sovremennyiy sotsioekonomicheskii slovar* (Modern socio-economic dictionary). Moskva (2009)
12. Klir, G. J., Yuan, B.: *Fuzzy sets and fuzzy logic: theory and applications*. New Jersey (1995)
13. Matlab, Fuzzy Logic Toolbox 2.1. https://www.mathworks.fr/academia/student_version/r2009a_products/fuzzylogic.pdf (2010). Accessed 24 Feb 2019
14. State statistics service of Ukraine. <http://www.ukrstat.gov.ua> (2019). Accessed 24 Feb 2019
15. Rukh abiturientok ta abiturientiv mizh oblastiamy Ukrainy: porivniannia 2017 ta 2018 rokiv (Mobility of university applicants in Ukraine: comparison, 2017 and 2018 years). <https://www.cedos.org.ua/uk/articles/rukh-abiturientok-ta-abiturientiv-mizh-oblastiamy-ukrainy-porivniannia-2017-ta-2018-rokiv> (2018). Accessed 10 Feb 2019
16. Sotula, O., Denysenko, V.: Application of fuzzy logic approach for the determination of the integral index of the implicit impact of the higher education system on regional development (on the example of Ukraine). *SHS Web of Conferences.* **65**, 07003 (2019). doi:10.1051/shsconf/20196507003

Driving Digital Transformation Through e-Government

Denis Trček^[0000-0003-0727-1324]

University of Ljubljana, Večna pot 113, Ljubljana, 1000, Slovenia
denis.trcek@fri.uni-lj.si

Abstract. Digital transformation is increasingly determining the development of societies through ubiquitous deployment of modern information technologies. One of the main drivers that are still not paid sufficient attention are application programming interfaces (APIs). These are not essential just for new services development and adoption, but have further reach and may result even in creation of new industries. Their importance is therefore not to be overlooked for further development, especially by taking into account that the main focus is still on developers (i.e. bottom-up approach). However, higher level business views (i.e. top-down approach) are to be considered in de facto and de iure APIs development, deployment and standardization processes, which is currently not the case. Therefore this paper presents a framework for facilitating APIs (services) evolution by considering top-down business views and their proper addressing. The approach builds on lessons learnt with complex services architectures, and their higher-level derivatives. In line with these lessons it defines implementation strategies at technological and business levels. The whole contribution is conceptualized around e-government services, because governments are key players in each and every economy, and their impact in digital transformation is therefore vital.

Keywords: digital transformation, application programming interfaces, advanced services, e-business, e-government.

1 Introduction

Nowadays, digital transformation is a reality that is driving not only traditional, tangible products focused primary and secondary sectors, but it extends all the way up through the tertiary to the quaternary sector with increasing number of advanced services. And governments present a central entity of digital transformation in quaternary sector. The reasons are rather straightforward.

Governments are typically one of the largest entities in national economies. Their budgets present significant – often major – portion of a country’s gross-domestic product (in case of Germany, for example, the current federal budget presents approx. 11% of its yearly GDP [1]). Despite this, when it comes to IT they are too often considered as entities that “passively” support citizens and businesses, while, in fact, they are drivers of whole e-economies:

1. First, governments play considerable roles in all of e-business relations, be it administration to business (A2B) and vice versa (B2A), administration to citizens (A2C) and vice versa (C2A), or administration to administration relations (A2A).
2. Second, considering their potential, they should play a major and active role also in further technology promotion through services they offer, e.g. e-government.

Currently, within the on-going digital transformation, application program interfaces, or APIs, play a pivotal role that exceeds their anticipated influence. Initially and still today, APIs are almost completely considered to be in the domain of developers, i.e. belonging to the technological domain (as stated in [2], “unlike past trends that market to business leaders, APIs market directly to developers”). However, the gathered evidence shows that they do not have significant impact only on the development on new services, but even creation of new industries through new business models [3].

Thus APIs are far more than pure technological artefacts. They affect business even at strategic levels and have to be treated accordingly. Put another way - the gap between top-down, business views focused approaches (e.g. e-government) and bottom-up, technology focused approaches (e.g. APIs) has to be bridged in appropriate way. And this is where the main contribution of this paper comes in. In the second section the relevant technological driving forces are analyzed together with historical perspective to include lessons learnt. This line of reasoning is further refined in the third section, where a new approach to integration of light REST (REpresentational State Transfer) and complex SOAP (Simple Objects Access Protocol) services is presented. The approach builds on existing de facto and de jure standards. In the fourth section the proposed management framework built around e-government initiatives is analyzed and discussed. There are conclusions in the fifth section, followed by acknowledgements and references.

2 The Evolutionary Elements Behind Digital Transformation

The era of e-business began in the mid-nineties of the former century when the Internet started to penetrate business domain [4]. It transformed many industries, starting with the services sector and followed later by tangibles producing sectors. New industries appeared based on new business models (which have transformed in IT inherently present added value), while traditional ones had to adapt many of their processes. As the operationalization and wide implementation of e-business paradigm required new knowledge at the intersection of rapidly evolving IT domain and management domain, a field of e-business engineering emerged [5]. Such approach is crucial, because it enables appropriate addressing of soft and hard factors, which will be also the case in the rest of this paper.

Let's focus now specifically on services. Already during their early development research focused not only on deployment, but also on their descriptions and discovery. This resulted in specifications of Simple objects access protocol (SOAP), Web services description language (WSDL) and Universal description, discovery and integration protocol (UDDI) [6] (SOAP – WSDL – UDDI triple is also referred to as WS-* family,

or remote procedure call, RPC, style services). It is worth to point out that, within this triple, WSDL was actually describing and API for SOAP services.

The SOAP / WSDL / UDDI development was still mainly of technological nature. It was about elementary software procedures (routines) at the business sub-operations level. To further address business needs (i.e. the levels above operations level, all the way to complete business processes), aggregation of these elementary routines was needed for WS-* architectures. But such efforts did not succeed. One well known example was ebXML (e-business eXtended Markup Language) standard proposed by UN CEFAT and OASIS [7], where complex business rules and processes description language were introduced. This was supposed to enable business solutions development with the business processes specifications, which could be almost automatically transformable into program code. However, this technology became very complex and it was too demanding in terms of required efforts and resources for their implementations. On top of this, automatic finding and deploying of available services by using UDDI did not take ground.

What are the lessons learnt for APIs framework? First, avoid too complex structures. Second, avoid imposing too strict specifications – preferably, these should be flexible and based on de iure and de facto solutions to a maximal possible extent. Additional argument for these two requirements is a huge success of lightweight and easier deployable REST services that are forming RESTful architectures. Business community started to deploy them extensively soon after their introduction, and access to these services started almost at the same time to via APIs. As shown in Fig. 1 APIs deployment shows (close to) exponential growth.

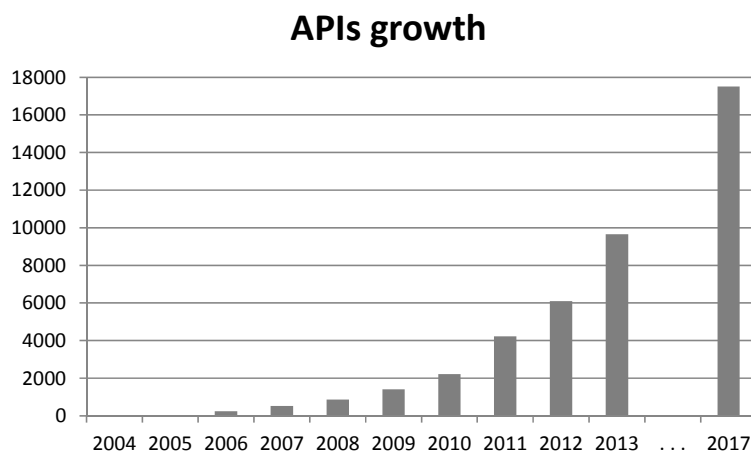

Fig. 1. The growth of REST APIs (source <https://www.programmableweb.com>).

However, the basic nature of RESTful architectures is such that they and their APIs are developers focused, most likely due to the fact that APIs are protocols intended to be used as interfaces by software components to communicate with each other in order to extend reach of their applications (services) [8]. This narrow view triggered some

authors to start exposing business importance of APIs. In [9] it is even exposed that APIs should be treated as a kind of contracts, which are linking the technological and business domains.

3 Fostering Business-centric APIs Through e-Government Services

Contrary to SOAP architectures, RESTful APIs have been primarily considered in a data-centric way so far. One understandable reason is due to many governments' goal that public data should be publicly available. RESTful solutions with their APIs come very handy to fulfill this goal, so it should not be surprising that also OECD in its Open Government Data document, when mentioning APIs, considers them in a data-centric way [8] (this subject is similarly handled in [10]).

Such data-centrism of REST APIs is also a natural consequence of the fact that these web services enable clients to access and manipulate textual representations of resources, i.e. data. Taking into account further that they are largely deployed in inter-organizational settings, while SOAP architectures remain notably limited to intra-organizational settings, there exists a gap. On one hand we have processes centric architectures that are very complex and limited to intra-organizations use, while on the other hand data centric architectures face huge inter-organizational success, but they remain limited to data without extensive offering of processes-centric support.

It can be concluded on the basis of the above given facts and the line of reasoning that REST APIs would benefit from supporting process-centric needs (see Fig. 2). However, imposing such addressing comes with a risk. If this is enforced (e.g. by *de jure* standardization processes), the natural bottom-up driven access may be blocked. Therefore, any *de facto* or *de jure* extensions of APIs should be flexible, potentially optional, and done in a way where existing technology can be included with minimal coding or reconfiguration effort.

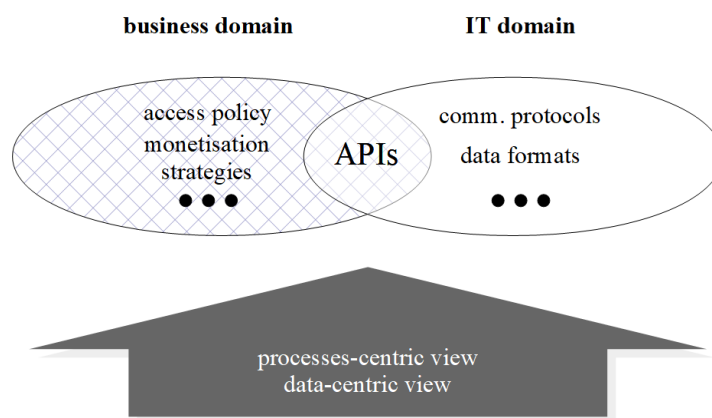

Fig. 2. APIs – linking the technology and business domains.

Before detailing out the proposed extensions to REST APIs, the most important existing standards this area should be briefly provided and analyzed:

- Currently the most promising industry standard, the winning player, is Open API Initiative, OAI, formerly known as Swagger [11]. OAI enables computers to discover and understand a service without accessing its source code or software documentation. This specification that is built upon JSON data representation is comprehensible also to humans, developers and non-developers. OAI is currently the main initiative in the field and it is based on open source software.
- A competing specification to OAI is RESTful API Modeling Language, RAML (<http://www.raml.org>), which, in turn, is based on a human-readable data serialization language YAML that is a superset of JavaScript Object Notation, JSON. Compared to OAI, RAML specification is supposed to provide more flexibility, even to an extent that includes support of architectures like SOAP [12].
- Beside OAI and RAML, another important specification (that is not an API per se) is Common Gateway Interface, CGI [13]. CGI is the oldest one and during the early ages of web it provided means for running scripts or programs on server's (the most successful language for this purposes was PHP, which is still among the most popular programming languages [14]). Despite popularity of CGI, its standardization never ended in *de iure* standards, although, contrary to a wider belief, CGI still is a *de facto* standard. It is natively supported by Apache servers, which have close to 50% market share [15]. Therefore, as Apache servers are natively backed by PHP, which may run in CGI mode or as an Apache module, CGI related kind of web services are still more than alive.

Let's now restate our basic problem as follows: Can we make RESTful architecture also processes-aware knowing that this architecture builds upon only PUT, POST, GET, DELETE, HEAD, and PATCH methods, where these methods operate exclusively upon textual resources provided through URIs? If so, the problem now is how to invoke also general procedures and not only data. These are the main options at our disposal:

- Option number one is a new specification (standard) that would use the best from both worlds, RESTful and SOAP, and fuse them.
- Option number two is that SOAP APIs and REST APIs remain as they are and an additional code at a server does the splitting / merging of the services.
- Option number three is to use REST service to accommodate SOAP service, i.e. make SOAP exposed as a REST.
- Option number four is that SOAP is used to accommodate and expose REST service (i.e. becoming incorporated into a SOAP service).
- The fifth option is CGI-BIN based web services deployment.

The first option would enable the best from both worlds, but it is unlikely to happen, as there are currently no such standardization efforts in sight. The second option would also actually pseudo-integrate the two worlds, but would require some adjustments to existing implementations. Nevertheless, it is a doable option, as such adjustments are

not excessive (so it is not surprising that certain implementations like Oracle SOA Suite already supports this option in a certain way). The third option is in principle undoable, as RESTful is about textual representations of resources manipulated by REST methods, while SOAP is about any kind of data manipulation and processing procedures (there exists a workaround with limited functionality by wrapping a SOAP call within a REST call). Now as to option four, this option is doable and there do exist such solutions [16], but it conceptually favors SOAP and ineffectively complicates REST parts. Finally, the fifth option is a solution that already exists, although it is tied to two particular technologies, Apache servers and PHP programming language. But these technologies are widely adopted and present *de facto* standard.

According to the above stated analysis, the data and processes focused merging of the two kinds of services can be enabled by using the architectures that are presented in Fig. 3 and Fig. 4. For the first proposed architecture a dispatcher (front-end processor) is introduced. Thus appropriate structuring of a service call needs to be defined. REST services that are nowadays tied to JSON, were initially tied to XML, which is about processes and data. Therefore, as XML technology is no stranger to REST architectures, an efficient way to implement dispatcher architecture goes as follows:

1. Use a minimal http server, where front-end processor is deployed that analyses requests from originators. Its parsing operation relies on appropriate XML schema that reflects composite service envelope structure, presented below.
2. Afterwards parsing, the request is split into REST and SOAP parts accordingly, while each part is forwarded to an intended destination servers.
3. After obtaining responses from the destination, the front-end processor merges the responses in an XML envelope and sends this enveloped content to the originator.

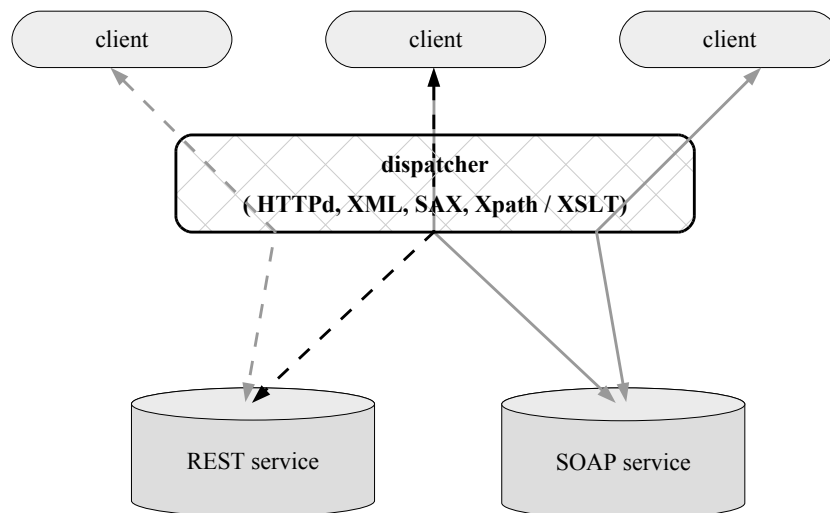

Fig. 3. Dispatcher architecture.

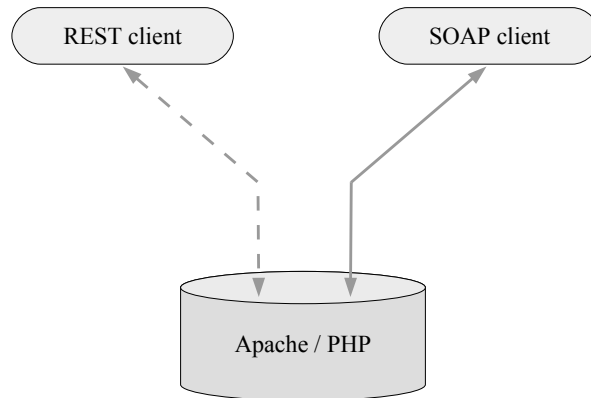

Fig. 4. Apache / PHP architecture.

The proposed solution is rather easy to implement with minimal programming, because the majority of tools already exist. For the first step Apache Tomcat server with containers can be used, while another option is implementation of a simple HTTP server that requires something between fifty to hundred lines of source code. For the second step, a widely available SAX (Simple API for XML) or DOM (Document Object Model) parser can be used. For the third step, XSLT (with XPath) can be used. What needs to be defined for the fourth step is a simple XML wrapper structure, i.e. an envelope for a composite service:

```
<compositeSrvc>
<RESTservice>...</RESTservice> <SOAPservice>...</SOAPservice>
</compositeSrvc>
```

The second proposed architecture is basically tied to PHP, and the approach is rather straightforward as well. The open source community offers solutions for years, where PHP scripting is integrated with Apache servers. Consequently, provisioning REST and SOAP is just a matter of proper installation and configuration of Apache / PHP pair.

4 Leveraging bottom-up with top-down approaches

Although the main-stream way of thinking about APIs nowadays is data-centric, there are quite some caveats why such view is likely insufficient for a general digital transformation. And this is the point where governments with their e-government services can make a critical technological push (One such initiative (and probably the first of this kind) has been implemented very recently by the state of Singapore [17]). Why such a push is needed, and how to approach it, is further elaborated next.

The first reason is purely technical – the emerging era of the internet of things, IoT, where many devices will lack computing resources, requires more than just raw data. These devices will be forced to “outsource” also significant part of processing. The

second reason is misconception that a straightforward utilization of data-centric APIs automatically leads to increased value of these data [19]. The third one is that although APIs are grounded on technological foundations, they have strong organizational implications and influence organizations even at strategic levels [9]. The fourth one is that properly conceptualized APIs enable creation of new business models and even new industries [9, 20], while successful penetration of e-government systems has a notable impact on business value creation, where this penetration depends on technological and (inter)organizational factors [21].

Further, and as already emphasized, for adoption of advanced IT services soft factors are at least as important as hard ones – APIs are no exception (such approach is emphasized also by OECD [18]). And the core concept that encompasses soft factors is new business model(s). Such models often lead to creation of new industries, not only products and services per se.

Now contrary to common belief that business models are something of importance just to commercial businesses, the truth is that they have lots to do with government agencies and alike as well [22]. Latently present added value in IT technology is released through appropriate business models, be it in commercial sector or public administration. Therefore taking into account the framework presented in this paper we anticipate that e-government provided APIs will also shape business models in general as shown in Fig. 5.

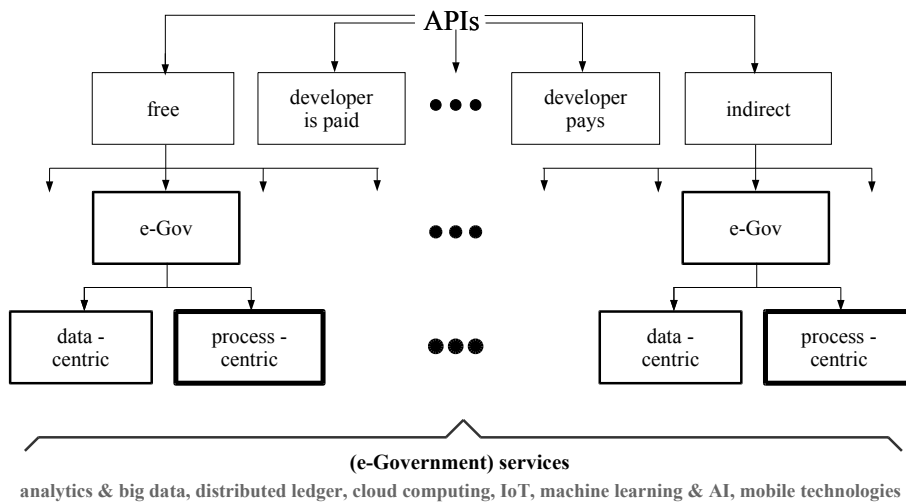

Fig. 5. APIs and e-government driven business models for digital transformation.

5 Conclusions

By following the e-business engineering principles, the approach in this paper focuses on digital transformation. This transformation is typically considered to be driven by the following technologies [23]: analytics, big data, distributed ledger, cloud

computing, internet of things, machine learning with AI, and mobile technologies. Further, it is considered to be driven by the following sectors: banking, consumer products, healthcare, high tech, manufacturing, retail and transportation [23].

However, this paper justifies that digital transformation in tertiary and quaternary sectors is becoming notably tied to APIs (which are front-ends for corresponding services) that are a kind of common denominator of the above technologies. It has been shown that APIs are currently primarily treated in a data-centric way, but they should be considered more broadly to encompass also process-centric views. It is further justified that among the above stated sectors, government sector is certainly among digital transformation drivers and should be included in related efforts – most naturally through e-government services. Such position well coincides with the general position of, e.g. EU Commission about digital scoreboard and related priorities [24, 25].

This presents the basis for the core contribution of this paper, which is architectural framework that relies on de facto and de jure standards to fulfil the above goals: increased digital transformation in services sectors by re-conceptualizing APIs and by focusing on governments' role through their e-government services. More precisely, by building on the influence of governments on many transformation processes, including the digital one, this paper presents a framework that binds business domain with technological domain. It re-conceptualizes the role that APIs currently play and extends it from being primarily about the data to be also about processes. And e-government paradigm with its services is the way to go, where concrete steps are presented that can be implemented with existing solutions and standards – the key accent is focus. Although being a soft factor, appropriate focus of governments has numerous hard consequences. The experience shows that it often enables new business models and creates even new industries. The very basic Internet is one such example and as such additionally justifies the research in the directions given in this paper. However, a large part of research performed so far has often not taken this view into account and has focused on issues like quality of e-government services (see, e.g. [26]).

Speaking purely technologically, the approach presented in this paper is about further services integration and thus presents an evolutionary step forward similar to the steps like front-end and back-end services integration that took place a decade ago [27]. Having integration in mind, future work will address further elaboration of the exposed issues, and eventually some minimal de jure standardization efforts in the area of REST APIs with shifting their focus from dominantly data-centric ones to balanced ones that equally cover processes. Again, if nothing else then the weak processing power segment of the emerging IoT population will stimulate such changes. As a consequence, the importance of security, privacy and safety will play an increased role [28]. Namely, these devices will barely possess required processing power for all possible use and application scenarios, which will therefore have to be harvested from the environment through APIs, even when lightweight solutions are considered.

6 Acknowledgements

Author would like to thank to Slovene research agency ARRS, which has supported this research work with founding the research program Pervasive computing, number P2-0359. A part of this research is also the result of collaboration in the ICT COST Action IC1304, Autonomous Control for a Reliable Internet of Services (ACROSS).

References

1. Zimmermann, N.: German federal budget goes up for 2017. Deutsche Welle. <http://www.dw.com/en/german-federal-budget-goes-up-for-2017/a-36528845> (2016). Accessed 24 Apr 2019
2. Higginbotham, J.: Designing Great Web APIs – Creating Business Value through Developer Experience. O’Reilly, Sebastopol (2015)
3. Columbus, L.: 2017 is Quickly Becoming the Year of the API Economy. Forbes <https://www.forbes.com/sites/louiscolumbus/2017/01/29/2017-is-quickly-becoming-the-year-of-the-api-economy/#1d950ac26a41> (2017). Accessed 30 Mar 2019
4. Trček, D.: Managing Information Systems Security and Privacy. Springer, New York (2006)
5. Kuo-Ming C.: E-services in e-business engineering, *Electronic Commerce Research and Applications*, **16**(7), 77–81 (2016)
6. Newcomer, E.: Understanding Web Services: XML, WSDL, SOAP, and UDDI, Independent technology guides. Addison-Wesley, Boston (2002)
7. The OASIS ebXML Joint Committee: The Framework for e-Business. OASIS. <http://www.oasis-open.org/> (2006). Accessed 24 Apr 2019
8. OECD: Open Government Data. Publications on Digital Government. <http://www.oecd.org/gov/digital-government/digital-government-publications.htm> (2013). Accessed 21 Mar 2019
9. Jacobson D., Brail, G., Woods D.: APIs: A Strategy Guide. O’Reilly Media, Sebastopol (2011)
10. Tauberer J.: Open Government Data: The Book (2nd Edition). <https://opengovdata.io/> (2014). Accessed 24 Apr 2019
11. The Open API Initiative: The Open API Specification v3. The Linux Foundation, <https://www.openapis.org/specification/repo> (2017). Accessed 24 Apr 2019
12. Sandoval, K.: Top Specification Formats for REST APIs. Nordis APIS. <http://nordicapis.com/top-specification-formats-for-rest-apis/> (2015). Accessed 24 Apr 2019
13. Robinson, D., Coar, K.: The Common Gateway Interface (CGI) Version 1.1, RFC 3875. IETF, Reston (2004)
14. Diakopoulos, N.: The 2017 Top Programming Languages: Focus on Jobs. *IEEE Spectrum*. <https://spectrum.ieee.org/computing/software/top-programming-languages-2017-focus-on-jobs> (2017). Accessed 24 Apr 2019
15. Netcraft, February 2017 Web Server Survey, <https://news.netcraft.com/archives/2017/02/27/february-2017-web-server-survey.html> (2017). Accessed 30 Mar 2019
16. predic8: Tutorial: Exposing SOAP Services as REST Resources. <https://www.membrane-soa.org/service-proxy-doc/4.4/rest2soap-gateway.htm> (2018). Accessed 30 Mar 2019

17. Basu, M.: Singapore builds government-wide API platform. GovInsider. <https://govinsider.asia/digital-gov/singapore-builds-government-wide-api-platform/> (2017). Accessed 30 Mar 2019
18. OECD: Digital Government Strategies for Transforming Public Services in the Welfare Areas, OECD Comparative Study. <http://www.oecd.org/gov/digital-government/digital-government-publications.htm> (2016). Accessed 30 Mar 2019
19. Tauberer, J.: Open Government Data: The Book. <https://opengovdata.io/2014/bulk-data-an-api/> (2014).
20. Caganoff, S.: API Business Models: 20 Models in 20 Minutes. InfoQ. <https://www.infoq.com/articles/api-business-models> (2013). Accessed 30 Mar 2019
21. Hossain, D., Moon, J., Kim, J.K., Choe, Y.C.: Impacts of organizational assimilation of e-government systems on business value creation: A structuration theory approach. *Electronic Commerce Research and Applications*. **10**(5), 576–594 (2011)
22. Kaplan, S.: Business Models Aren't Just for Business. *Harvard Business Review*. <https://hbr.org/2011/04/business-models-arent-just-for> (2011). Accessed 30 Mar 2019
23. SAP: Digital Business and Transformation. <https://www.sap.com/trends/digital-business.html> (2017). Accessed on 30 Mar 2019
24. EU Commission: Digital Scoreboard. <https://ec.europa.eu/digital-single-market/en/digital-scoreboard> (2017). Accessed 30 Mar 2019
25. EU Commission: Commission and its Priorities, Digital Society. https://ec.europa.eu/commission/tags/digital-society_en (2017). Accessed 30 Mar 2019
26. Soledad, M.J., Miranda, F.J.: Quality in e-Government services: A proposal of dimensions from the perspective of public sector employees. *Telematics and Informatics*. **35**(2), 457–469 (2018)
27. Glushko, R.J., Tabas, L.: Designing service systems by bridging the “front stage” and “back stage”. *Information Systems and e-Business Management*. **7**(4), 407–427 (2009)
28. Trček, D., Brodnik, A.: Hard and soft security provisioning for computationally weak pervasive computing systems in e-Health. *IEEE Wireless Communications*. **20**(4), 22–29 (2013)
29. Trček, D.: APIs and emerging economy - driving digital transformation through e-government. *SHS Web of Conferences*. **65**, 04009 (2019). doi:10.1051/shsconf/20196504009

Modeling the Economic Efficiency of Advertising

Alina Vinkovska, Arnold Kiv, Tatyana Koycheva, Liliia Bodnar and Ivan Donchev

South Ukrainian National Pedagogical University named after K. D. Ushynsky, Odessa,
Ukraine

alina.vinkovskaya@gmail.com, kiv.arnold20@gmail.com,
tikoycheva@gmail.com, bodnar179@gmail.com

Abstract. The development of the economy and trade has led to the widespread use of advertising and the need for its constant improvement. There is a vast field of advertising theory. This paper proposes an information model of the functioning of advertising. We introduce ideas about useful and harmful (excess) information. The concept of user's thesaurus is also introduced. The effectiveness of advertising is determined by the mutual influence of useful and redundant information. Differential equations are formulated on this basis, the solution of which allows to establish the patterns of the influence of psychological characteristics of users and the mode of presentation of information on the effectiveness of advertising.

Keywords: advertising theory, information model, effectiveness of advertising.

1 Introduction: State of the Advertising Research

The advertising research has two directions. One of them consists in the staging of purposeful experiments and the creation of empirical formulas describing the identified experimental consistency. Another direction is the development of models and the mathematical description of these models. Then a comparison with experiment is carried out.

In [1-3] experiments were described to examine memory interference in an advertising context. The processes of remembering and forgetting advertising blocks in the human's brain are depending on the quality of blocks, clarity of advertisement.

At first, consumer memory for some advertising was inhibited as a result of subsequent exposure for other products in that manufacturer's product line and for competing products in the same product class. It happens preferably in the case of some kind of advertisement which is more attractive. Next, an experiment was performed which showed the analogous interference effects. In the third case it was obtained that the presence of advertising for competitive products changes the relationship between the repetition and consumer memory. Repetition had a positive effect only when there was little or no advertising for similar products [4]. This effect was also studied in the works [5, 6, 21, 24, 27, 29], in which the found experimental patterns are described using empirical formulas.

Mathematical models in this field have been developed for a long time [6-9, 20, 31-33]. They described empirical results in mathematical language. By this way, fundamental patterns are obtained. In [10-16, 39] a dynamic model of the company's sales dependence on advertising costs is constructed. It was shown that the advertising allows you to increase sales, but the dependence of increasing demand from increased advertising costs is not linear. Authors claimed that the advertising does not work instantly, since its inception, the information is accumulated in the minds of people with each meeting with advertising and reaches the peak after a certain time.

In our work, we use some representations of information theory for the implementation of an information approach with the aim of increasing the effectiveness of advertising.

Presentation of advertising is essentially a message of information to the consumer [17-19]. Therefore, the problem of increasing the effectiveness of advertising is reduced to considering the quality of the information presented, the mechanisms of its creation and presentation to the recipient, the psychological characteristics of perception of information by the recipient.

When creating advertising, along with clearly marked target information, extra information is usually added to "decorate" advertising [22, 26, 28]. This immediately affects the perception of useful target information. Further, in the course of the operation of advertising (in the course of its multiple presentations), the effect of "redundant information" arises.

This effect increases with time, prevents the perception of useful information and depends on the psychological characteristics of the recipient.

Information theory introduces the concept of information usefulness. Bongard [37] connects the usefulness of information with an increase in the probability of achieving the goal after receiving a message, in accordance with the formula:

$$V = \log_2 (P'/P) \quad (1)$$

Here, P and P' are the probability of achieving the goal before and after receiving the information.

According to formula (1), the redundant information has zero value. However, in many cases, redundant information turns out to be useful and even necessary [38, 40-42].

In the case of the creation and operation of advertising excess information harms, reducing the effectiveness of advertising.

In the majority of works devoted to study the properties of advertising, it is believed that over time (an increase in the number of repeated presentations of advertising) there is an accumulation of information (I) perceived by the recipient (for example, [1-4]).

In fact, from the very beginning the advertising presents the necessary information for the recipient, and at subsequent presentations the new information is not added. Therefore, to talk about the accumulation of information for the recipient over the time of the functioning of advertising (increasing the number of presentations) is not entirely correct. That is why we introduce the concept of "enhancing of the information impact" which is not equivalent to the idea of the accumulation of information.

2 Description of the Information Approach in the Advertising Research

Usually the first perception of a new advertisement is surface, inaccurate and not fully understood [25, 30, 34-36]. Although the new information is not added, subsequent presentations of this ad lead to the fact that its content becomes more conscious, understandable, more deeply perceived.

For a quantitative description of the process of perception of advertising information, we found it convenient to identify the process of deeper “mastering” advertising with the accumulation of additional information and introduce a function of the information accumulation $I = f(t)$. We assume that the number of advertisements presented (n) is proportional to time (t).

With a large number of presentations of advertising, its content is completely assimilated by the recipient and after some time begins to be perceived as redundant information. In this case, the accumulation of redundant information adversely affects the perception of useful information.

Thus, the perception of advertising depends on the mutual influence of useful and harmful (redundant) information. It is obvious that at the initial stages of the functioning of advertising, the influence of useful information prevails, but over time, as the accumulation of excess information, the latter dominates. The period of time after which the information begins to be primarily perceived as excessive depends on the psychological characteristics of the recipients and on their thesaurus.

But not only redundant information with a large n can adversely affect the perception of advertising. At the very beginning of the presentation of advertising (when it is created) it can contain harmful information that has a negative impact on the perception of advertising. Therefore, from the very beginning, the model should take into account the impact on the recipient of positive and negative information, as well as the interaction of these two types of information. We will consider positive information (contributing to the achievement of the goal of advertising) with a plus sign and negative information (reducing the effect of positive information) with a minus sign.

3 Formulation of Equations and Discussion of Results

Naming by $I_1(t)$ and $I_2(t)$ the functions of accumulation of positive and negative information, we write the kinetic equations:

$$\frac{dI_1}{dt} = T - \beta I_2 \quad (2)$$

$$\frac{dI_2}{dt} = -\beta' I_1 - T \quad (3)$$

In equations (2) and (3) T is a thesaurus of recipients; β is a coefficient of influence of the negative information on the positive one and β' is a coefficient of influence of the positive information on the negative one. It is presumed that $\beta, \beta' < 1$. From equations (2) and (3) we go to equation (4)

$$\frac{d^2 I_1}{dt^2} = -\beta \{ -\beta' I_1 - T \}. \quad (4)$$

The last equation has a solution:

$$I_1 = C_1 + C_2 e^{\beta\beta' t} - \frac{T}{\beta'} \quad (5)$$

where C_1 and C_2 are constants that are determined by initial conditions.

Using (4) one can write expression for I_2 :

$$I_2 = \frac{1}{\beta} \{ T - \beta\beta' C_2 e^{\beta\beta' t} \} \quad (6)$$

With initial conditions:

$$I_1(0) = I_2(0) = 0; \quad (7)$$

we obtain:

$$C_2 = \frac{T}{\beta\beta'}; \quad C_1 = T \frac{\beta-1}{\beta\beta'} \quad (8)$$

As a result, we get:

$$I_1 = \frac{T}{\beta\beta'} \{ e^{\beta\beta' t} - 1 \} \quad (9)$$

$$I_2 = \frac{T}{\beta} [1 - e^{\beta\beta' t}] \quad (10)$$

For large enough time periods one can write:

$$I_1 = \frac{T}{\beta\beta'} \{ [e^{\beta\beta' t}] \} \quad (9')$$

$$I_2 = -\frac{T}{\beta} [e^{\beta\beta' t}] \quad (10')$$

These results show that an accumulation of both kinds of information (I_1 and I_2) depends on their mutual influence. It is important that parameter values β and β' change in the process of advertising functioning. The competition of information I_1 and I_2 accumulation processes leads to the conclusion about two stages of advertising evolution. At the first stage, accumulation of I_1 information prevails and at the second stage accumulation of I_2 information prevails.

Considering solutions (9') and (10'), we take into account that these dependencies obtained are determined primarily by the exponent. We also take into account that at the first stage, β is small compared to β' , and practically does not change. There is only a gradual increase in β' . This leads to the quality result illustrated in Fig. 1.

This situation persists at the first stage of the functioning of advertising. I_2 slightly decreases an accumulation of I_1 . Expression (10') does not adequately describe the situation at the first stage, since the amount of redundant information is still small

The situation changes at the second stage of the functioning of advertising. Over time, the nature of the mutual influence of the two types of information changes. The

effect of I_2 on I_1 increases, and the influence of I_1 on I_2 drops. At the second stage of the functioning of advertising negative (redundant) information predominantly increases. This means that the effect of positive information will be reduced and although I_1 according to formula (9) continues to increase, but the “effective” value of I (I_1+I_2) decreases. In fact, I_1 turns into I_2 , because the accumulation of redundant information in accordance with the model reduces the “quality” of positive information, therefore – its quantity. The noted patterns are qualitatively shown in Fig. 2.

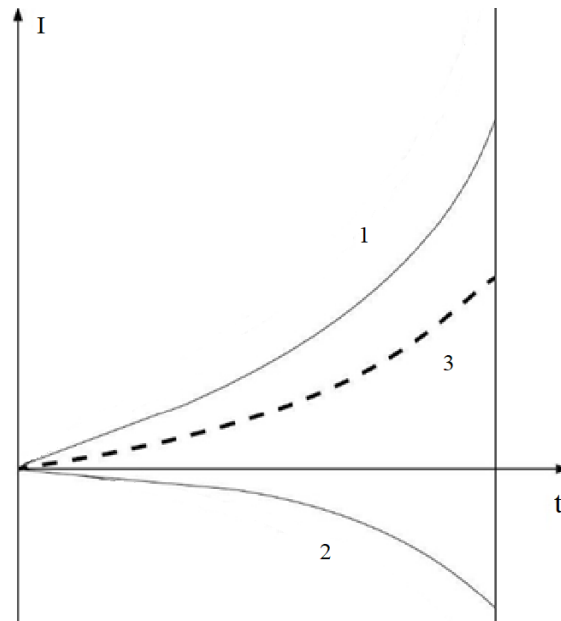

Fig. 1. Schematic illustration of I_1 information accumulation at the first stage of functioning of an advertisement. The curve 1 corresponds to I_1 accumulation and the curve 2 to I_2 accumulation. The curve 3 is an accumulation of a total positive information received by the recipient.

The perception of useful information throughout the operation of advertising (in fact, its effectiveness) is demonstrated in Fig. 3.

Based on the expressions (9) and (10) for the relative effectiveness (δ) of advertising can be written:

$$\delta = \frac{I_1}{I_1 + I_2} \quad (11)$$

$$I_1 + I_2 = T \frac{1-\beta'}{\beta\beta'} (e^{\beta\beta' t} - 1) \quad (12)$$

$$\delta = \frac{T}{\beta\beta'} / \frac{T(1-\beta')}{\beta\beta'} \quad (13)$$

$$\delta = \frac{1}{1-\beta'} \quad (14)$$

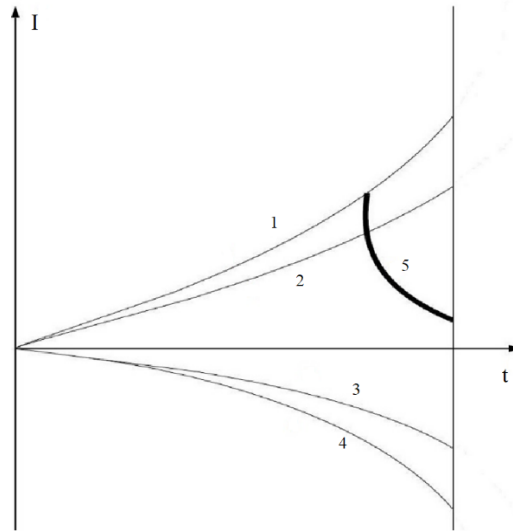

Fig. 2. Schematic illustration of accumulation of a total information received by the recipient at the second stage. The first and the second curves correspond to the accumulation of positive information for two values parameters β' ($\beta'_1 > \beta'_2$), parameter β does not change. The third and the fourth curves correspond to accumulation of negative information for two values of parameter β ($\beta_3 < \beta_4$), β' does not change. The fifth curve corresponds to accumulation of total positive information received by the recipient.

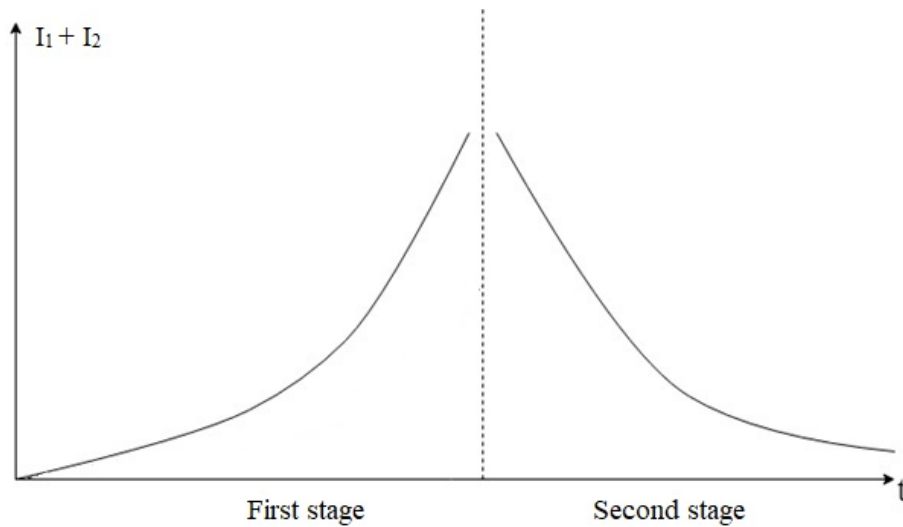

Fig. 3. Schematic illustration of total positive information received by the recipient during two stages of functioning of advertising.

Formula (14) in accordance with our model shows that relative effectiveness of advertising depends on the influence of the value of parameter β' . As we noted above, formula (9') describes the accumulation of positive information at the first stage of the advertising operation and formula (10') is applied to the second stage.

Due to the quality of advertisement the action of the advertising can be started in the different moments of time. This means that advertising can be disconnected for a while and then re-presented.

If the action of the ad starts at the moment t_1 the initial conditions will be formulated as:

$$I_1(t_r) = 0; \quad I_2(t_r) = 0 \quad (15)$$

In this case using expressions (5) and (6) we obtain:

$$C_1 + C_2 - \frac{T}{\beta'} = 0 \quad (16)$$

$$\frac{1}{\beta'} \{ T - \beta\beta' C_2 e^{\beta\beta' t_r} \} = 0 \quad (17)$$

$$T - \beta\beta' C_2 e^{\beta\beta' t_r} = 0 \quad (18)$$

$$C_2 = \frac{T}{\beta\beta' e^{\beta\beta' t_r}} \quad (19)$$

$$C_1 = T \left(\frac{1}{\beta'} - \frac{1}{\beta\beta' e^{\beta\beta' t_r}} \right) \quad (20)$$

As a result, constants C_1 and C_2 , in contrast to (8), are follows:

$$C_1 = T \left(\frac{1}{\beta'} - \frac{1}{\beta\beta' e^{\beta\beta' t_r}} \right); \quad C_2 = \frac{T}{\beta\beta' e^{\beta\beta' t_r}} \quad (21)$$

Substituting these constants to (5) and (6) and using the formula (11) we obtain:

$$\delta = \frac{e^{\beta\beta' t_r}}{e^{\beta\beta' t_r} + \frac{T}{\beta'}} \quad (22)$$

In this case the relative effectiveness of the advertisements significantly depends on the time when the advertisement does not act. We also see that in contrast to formula (14) in the last case the relative effectiveness depends on the thesaurus of recipients.

4 Conclusion

The effectiveness of advertising is determined by the perception of positive information by the recipient. Analysis of the information model of advertising leads to the conclusion of a two-stage process of functioning of advertising. This is due to the influence of redundant information on useful information that should be perceived by the recipient. Excess information appears as a result of multiple presentation of the

same advertising material. We claim that in the case of the advertising operation the redundant information is always harmful.

It is significant that the accumulation of both types of information occurs differently at different stages of the functioning of advertising. In the first stage, mainly positive information is accumulated. The accumulation of redundant (negative) information begins with a sufficiently large number of presentations of advertising (in the second stage). In this case, the accumulation of positive information continues, but it is suppressed by the predominant accumulation of negative information.

In Figure 1, the vertical line conventionally separates the two stages of the functioning of advertising. The position of this line depends on the psychological characteristics and the thesaurus of the recipients. Thus, when creating advertising, it is important to evaluate the period corresponding to the first stage of the functioning of an advertisement, for which a special psychological research is necessary. The effect of advertising depends not only on the quality of advertising, but also significantly on the thesaurus and psychological characteristics of the recipient.

The dependence shown in Fig. 1 is of the identical form as the experimental curves [3].

The obtained results show that for different initial conditions the advertisements act in different ways relatively their effectiveness (δ). It means that in the real conditions of advertisement operation its effectiveness can change not only in accordance with mentioned stages but under influence of other factors, such as turning off and subsequent turning on of the advertisement.

References

1. Burke, R.R., Srull, T.K.: Competitive Interference and Consumer Memory for Advertising. *Journal of Consumer Research*. **15**(1), 55–68 (1988)
2. Batra, R., Ray, M.L.: Situational Effects of Advertising Repetition, The Moderating Influence of Motivation, Ability, and Opportunity to Respond. *Journal of Consumer Research*. **12**(4), 432–445 (1986)
3. Lutoshkin, I., Yamaltdinova, N.: The Existence of the Solution to the Control Problem of Advertising Expenses with Distributed lag. *The Bulletin of Irkutsk State University. Series Mathematics*. **18**, 48–59 (2016)
4. Lutoshkin, I.: Modeling a response function to frequency of advertising. *Applied Econometrics*. **19**(3), 101–111
https://econpapers.repec.org/scripts/redir.pf?u=http%3A%2F%2Fpe.cemi.rssi.ru%2Fpe_2010_3_101-111.pdf;h=repec:ris:apltrx:0052 (2009). Accessed 21 Mar 2019
5. Fitch, D.: *Optimizing Ads: Is Less Always More? KMB: Point of View* (2013)
6. Lipstein, B.: A Mathematical Model of Consumer Behavior. *Journal of Marketing Research*. **2**(3), 259–265 (1965). doi:10.1177/002224376500200305
7. Cosgun, O., Gultas, I., Serarslan, M.N.: Application of a mathematical model to an advertisement reservation problem. *An International Journal of Optimization and Control: Theories & Applications (IJOCTA)*. **3**(1), 23–33 (2013). doi:10.11121/ijocta.01.2013.00133
8. Lutoshkin, I., Yamaltdinova, N.: The Dynamic Model of Advertising Costs with Continuously Distributed Lags. *CEUR Workshop Proceedings*. **2018**, 103–112 (2017)
9. Zhao, B., Li, Y.K., Lui, J.C.S., Chui, D.: Mathematical Modeling of Advertisement and Influence Spread in Social Network.

- http://netecon.seas.harvard.edu/NetEcon09/Papers/Zhao_09.pdf (2009). Accessed 21 Mar 2019
10. Chernousova, Zh.T.: Modeling an effective strategy of Advertising Investments of Firm in The Competitive Market. *Economical Review of NTUU "KPI"*. 15, 512–519 (2018)
 11. Nan, X., Faber, R.J.: Advertising theory: Reconceptualizing the building blocks. *MT*. 4(1-2), 7–30 (2004). doi:10.1177/1470593104044085
 12. Ippolito, R.A.: Consumer Reaction to Measures of Poor Quality: Evidence From The Mutual Fund Industry. *The Journal of Law & Economics*. 35(1), 45–70 (1992)
 13. Lee, A.M., Burkart, A.J.: Some Optimization Problems in Advertising Media Planning. *OR*. 11(3), 113–122 (1960). doi:10.2307/3007052
 14. Shih, W.: Optimal Inventory Policies When Stockouts Result From Defective Product. *International Journal of Production Research*. 18(6), 677–686 (1980). doi:10.1080/00207548008919699
 15. Resnik, A., Stem, B.L.: An Analysis of Information Content in Television Advertising. *Journal of Marketing*. 41(1), 50–53 (1977). doi:10.2307/1250490
 16. Nelson, P.: Advertising of information. *Journal of Political Economy*. 82(4), 729–754 (1974). doi:10.1086/260231
 17. Andrews, C., Netemeyer, R.G., Burton, S.: Consumer Generalization of Nutrient Content Claims in Advertising. *Journal of Marketing*. 62(4), 62–75 (1998). doi:10.2307/1252287
 18. Faber, R.J., Lee, M., Nan, X.: Advertising and the Consumer Information Environment Online. *American Behavioral Scientist*. 48(4), 447–466 (2004). doi:10.1177/0002764204270281
 19. Donnely, J.H.Jr.: Attitude toward Culture and Approach to International Advertising. *Journal of Marketing*. 34(3), 60–63 (1970). doi:10.1177/002224297003400312
 20. Scholten, M.: Lost and Found: The Information-processing Model of advertising effectiveness. *Journal of Business Research*. 37(2), 97–104 (1996). doi:10.1016/0148-2963(96)00058-6
 21. Wies, S., Hoffmann, A.O.I., Aspara, J., Pennings, J.M.E.: Can Advertising Investment Counter the Negative Impact of Shareholder Complaints on Firm Value? *Journal of Marketing* (2019). doi:10.1177/0022242919841584
 22. Sternthal, B., Craig, C.S.: Humor in Advertising. *Journal of Marketing*. 37(4), 12–18 (1973). doi:10.2307/1250353
 23. Taylor, C.R.: How to Avoid Marketing Disaster: Back to the Communications Model, But with Some Updates Illustrating the Importance of E-Word-of-Mouth Research. *International Journal of Advertising: The Review of Marketing Communications*. 36(4), 515–519 (2017). doi:10.1080/02650487.2017.1323406
 24. Goodwin, S., Etgar, M.: An Experimental Investigation of Comparative Advertising: Impact of Message Appeal, Information Load, and Utility to Product Class. *Journal of Marketing Research*. 17(2), 187–202 (1980). doi:10.1177/002224378001700203
 25. Till, B.D., Shimp, T.A.: Endorsers in Advertising: The Case of Negative Celebrity Information. *Journal of Advertising*. 27(1), 67–82 (1998)
 26. Wolfe, S.M.: Direct-to-Consumer Advertising – Education or Emotion Promotion? *The New England Journal of Medicine*. 346, 524–526 (2002). doi:10.1056/NEJM200202143460713
 27. Lavidge, R.J., Steiner, G.A.: A Model For Predictive Measurements of advertising Effectiveness. *Journal of Marketing*. 25(6), 59–62 (1961). doi:10.2307/1248516
 28. Reichert, T.: Sex in Advertising Research: A Review of Content, Effects, and Functions of Sexual Information in Consumer Advertising. *Annual Review of Sex Research*. 13(1), 241–273 (2002)

29. Zielske, H.A.: The Remembering and Forgetting of Advertising. *Journal of Marketing*. **23**(3), 239–243 (1959). doi:10.2307/1248262
30. Ullah, N., Hussain, M.: Impact of Unethical Misleading Information or Deceptive Advertising on Customer Purchasing Intention with Mediating Effect of Word of Mouth: Case of Pakistan. *International Journal of Innovation and Economic Development*. **1**(4), 49–69 (2015). doi:10.18775/ijied.1849-7551-7020.2015.14.2005
31. Feichtinger, G., Hartl, R.F., Sethi, S.P.: Dynamic Optimal Control Models in Advertising: Recent Developments. *Management Science*. **40**(2), 195–226 (1994)
32. Smith, R.E., Yang, X.: Toward a General Theory of Creativity in Advertising: Examining the Role of Divergence. *Marketing Theory*. **4**(1-2), 31–58 (2004). doi:10.1177/1470593104044086
33. Becker, G.S., Murphy, K.M.: A Simple Theory of Advertising as a Good or Bad. *The Quarterly Journal of Economics*. **108**(4), 941–946 (1993). doi:10.2307/2118455
34. Mikołajczak-Degrauwe, K., Brengman, M.: The Influence of Advertising on Compulsive Buying – The Role of Persuasion Knowledge. *J Behav Addict*. **3**(1), 65–73 (2014). doi:10.1556/JBA.2.2013.018
35. Braun-LaTour, K.A., LaTour, M.S., Pickrell, J.E., Loftus, E. F.: How and When Advertising Can Influence Memory for Consumer Experience. <https://scholarship.sha.cornell.edu/cgi/viewcontent.cgi?article=1319&context=articles> (2004). Accessed 21 Mar 2019
36. Zeng, F., Tao, R., Yang, Y., Xie, T.: How Social Communication Influence Advertising Perception and Response in Online Communicaties? *Front Psychol*. **8**, 1349 (2017). doi:10.3389/fpsyg.2017.01349
37. Bongard, M.M.: *Pattern Recognition*. Spartan Books, Rochelle Park (1970)
38. Schwartz, R.N., Townes, C.H.: Interstellar and Interplanetary Communication by Optical Masers. *Nature*. **190**, 205–208 (1961)
39. Gerasymenko, A.G.: Informative Advertising: A Market Information Provider or a Seed of Market Power? *Ecoforum Journal*. **1**(1). <http://ecoforumjournal.ro/index.php/eco/article/view/20> (2012). Accessed 21 Mar 2019
40. Acerbi, A., Tennie, C.: The Role of Redundant Information in Cultural Transmission and Cultural Stabilization. *J Comp Psychol*. **130**(1), 62–70 (2016). doi:10.1037/a0040094
41. Zain-Ul-Abideen, Saleem, S.: Effective advertising and its Influence on Consumer Buying Behavior. *European Journal of Business and Management*. **3**(3), 114–119 (2012)
42. Burton, J.L., Collins, J., McNeely, L.E., Walls, D.M.: Revisiting the Relationship between Ad Frequency and Purchase Intention. *Journal of Advertising Research*. **82**(4), 729–754 (2019). doi:10.2501/JAR-2018-031
43. Vinkovska, A., Kiv, A., Koycheva, T., Bodnar, L., Donchev, I.: Information model of the economic efficiency of advertising. *SHS Web of Conferences*. **65**, 04022 (2019). doi:10.1051/shsconf/20196504022

Fuzzy Production Model for Managing Court Decisions in the Case of Theft

Anna Bakurova^[0000-0001-6986-3769], Mariia Pasichnyk^[0000-0002-5179-4272],
Elina Tereschenko^[0000-0001-6207-8071] and Yurii Filei^[0000-0002-1264-2831]

Zaporizhzhya National Technical University, 64, Zhukovskoho Str., Zaporizhzhia, 69061,
Ukraine

abaka111060@gmail.com, mashali@ukr.net,
elinatereschenko@ukr.net, fileyyuriy@gmail.com

Abstract. The economic essence of the theft, as a crime against property, and its connection to unemployment is revealed. The general model of the support system making court decisions as fuzzy production system is developed. For the case of theft (Article 185 of the Criminal Code of Ukraine), two variants of the implementation of the fuzzy production system – the Mamdani and Sugeno algorithms – are proposed. Incorporation of the developed model into the “Electronic Court” system, which is a feature of the information society, is able to increase the level of automation of judicial practice and prevent corruption.

Keywords: unemployment, theft, decision support system, court decision, linguistic variable.

1 Introduction

In addition to the legal aspect, the concept of theft has an economic essence, since it is a crime against property. Theft is defined as a set of actions committed by one or a group of entities that provide for secret seizure or gainful possession of property, which subsequently harms the economic activity of both natural and legal persons. Thefts are the most frequent crimes committed in Ukraine - they account for more than 40% of the total number of reported crimes. The dynamics of the thefts is shown in Table 1. The data are taken from open sources, the website of the Prosecutor General’s Office of Ukraine [1].

Table 1. The dynamics of the thefts in 2013-2018 years.

Year	Total crimes	Theft	The percentage of theft from the total number of crimes
2013	563560	242769	43.07%
2014	529139	226833	42.86%
2015	565182	273756	48.43%
2016	592604	312172	52.67%
2017	523911	261282	49.87%
2018	487133	238492	48.95%

The main factors of the theft spread in Ukraine are: decrease in the living standards of the population as a result of the socio-economic crisis, changes in legislation on the qualification of such a crime as theft, unemployment. About 65% of thefts at the time of the crime commission were not taken in work and educational activities, more than a third were previously tried [2].

Punishment appointing is rather complicated and multidimensional process. According to the Art. 65 of the Criminal Code of Ukraine [3], the court imposes punishment within the limits established in the sanction of the Special Part Article of the Criminal Code, which provides for responsibility for the committed crime, in accordance with the provisions of the General Part of the Criminal Code, taking into account the gravity degree of the offense, the person of the offender the circumstances that mitigate and burden the punishment. During choosing a sentence, the judge must evaluate all elements of the crime and all the circumstances of its implementation in order to determine the extent of liability of the defendant and the appointment of him a co-sentence punishment. The degree of punishment, depending on the composition of the crime is regulated by the rules of law, which allows formally determine the limits of maximum and minimum penalty. In addition to the objective factors in this process, there is also subjectivity, the so-called judicial oversight. The choice of the type of punishment where the law provides for alternative sanctions remains for the judge. Consequently, the weakly formalized part of the sentence remains the assessment of the circumstances of committing a crime and the characteristics of the guilty person. While judges do not require a detailed comment on the criteria for evaluation, the need for a very motivated choice of punishment is clearly regulated. To unify the account of mitigating and burdening circumstances and the guilty person it is natural to formalize their assessments. The development of a general knowledge base for sentencing, with all possible combinations of different circumstances, gives hope for similar sentences in similar composition and circumstances of crimes.

The object of this study is the process of taking court decisions in case of theft. The subject of the study determines the methods of collecting and analyzing the parameters of real court decisions presented in the natural language.

The purpose of the article is to build a general decision support system (DSS) in court as a fuzzy production system, as well as to conduct a cycle of experiments with a developed DSS based on real case data from the Unified State Registry of Judicial Decisions in Ukraine [4].

2 Problem Statement

Punishment appointing is rather complicated and multidimensional process. According to the Art. 65 of the Criminal Code of Ukraine, the court imposes punishment within the limits established in the sanction of the Special Part Article of the Criminal Code, which provides for responsibility for the committed crime, in accordance with the provisions of the General Part of the Criminal Code, taking into account: 1) the gravity degree of the offense, 2) the person of the offender, 3) the circumstances that mitigate and burden the punishment.

The legislative sanction of the article takes into account both quantitative indicators of the relevant circumstances and qualitative ones.

In accordance to this, were chosen the following input variables.

The linguistic variable *Severity*, which characterizes the degree of gravity of the offence, takes on the meaning of the term set {small, medium, large}. This variable allows you to take into account the repetition of a crime, the existence of past punishment, a collective crime, and so on.

The linguistic variable *Personality* characterizes the identity of the offender and takes value with the term set {negative, neutral, positive}. It allows for taking into account, for example, employment, availability of socially useful activities, description from the place of residence, etc.

It should be noted, that according to Part 3 of Art. 66 of the Criminal Code of Ukraine, if in any of the circumstances mitigating the punishment provided for in the Article of the Special Part of the Criminal Code as a sign of a crime that affects his qualification, the court can not once again take it into account when imposing a punishment as such that mitigate the punishment [3]. There are eleven mitigate circumstances. Two linguistic variables were chosen to assess the circumstances, that mitigate the punishment. The linguistic variable *Mitigation* evaluates the possibility of taking into account a judge of a certain number of realized circumstances. The linguistic variable *LM* assesses the level of punishment mitigation by circumstances, that were implemented.

Also, during constructing the algorithm of sentencing, we have taken the specified in Art. 67 of the Criminal Code of Ukraine, burdening circumstances. Such circumstances are determined by fourteen. When imposing a sentence, the court can not recognize that it is burdened by other circumstances. If any of the circumstances that burden a punishment is stipulated in the Article of the Special Part of the Criminal Code as a sign of a crime affecting its qualification, the court can not re-consider it when imposing a sentence as burden it [3]. Input variables to assess the circumstances that impose a punishment on *Burden* and *LB*. The linguistic variable *Burden* gives an assessment of the possibility of taking into account a certain number of realized circumstances. The linguistic variable *LB* assesses the level of punishment burden by the circumstances that were implemented.

The linguistic variable *Lawyer* characterizes the level of neutrality of the judge and takes on the meaning of the term-set {soft, middle, hard}. We will assume that the judge is fair in the level of "middle". Introduction of additional terms will put the problem of the adequacy of the sentence, the impact assessment of judges person.

The court may impose a measure of punishment, the constituent parts of which are fines, restrictions of freedom and imprisonment (real and conditional), public works. Assign the following output variables.

The output linguistic variable *Fine* determines the size of the fine. The output linguistic variable *Years* determines the term of imprisonment. The output linguistic variable *RF* (Restriction of freedom) determines the level of freedom restrictions. The output linguistic variable *Public Works* determines the public works. The output linguistic variable *Condition* determines real and conditional imposition of punishment.

For all output linguistic variables were chosen the term-set, which contain three terms that characterize the implementation level {low, medium, high}.

The membership functions of the terms of input and output linguistic variables are determined by experts. Value ranges are regulated by the relevant legislation separately for each article. Thus, the general DSS model in court has the form:

$$(Fine, Years, RF, Public Works, Condition) = \\ =F(Severity, Personality, Mitigation, LM, Burden, LB, Lawyer), \quad (1)$$

where F is the corresponding fuzzy output algorithm.

For the experiment, the authors selected art. 185 of the Criminal Code of Ukraine on theft [3].

Different parts of Article Art. 185 of the Criminal Code of Ukraine on theft [3] have different versions of sentences. Difficulty base of fuzzy production rules will be determined by the content of certain articles.

3 Literature Review

The problem of limitation of the court decisions objectivity was raised in 1963 in Clark's work, "The Limits of Judicial Objectivity", which pointed to the basic rule for passing judgments: "Government of laws, and not of men" [5]. But achieving the perfect implementation of such a rule is impossible for a number of reasons, one of them is the uncertainty of many legal concepts. This is confirmed by the fact that the European Court, in view of the versatility of the notion of "justice" in decisions of national courts, does not define the criteria for a fair judicial discretion, but only sets out its tentative decision taking into account the provisions of Art. 6 "Convention for the Protection of Human Rights and Fundamental Freedoms" [6].

The approach to defining the fuzzy notion of "fair court" was proposed, in particular, in the work of Yu. Tobot [7], where the notion of "impartiality" was adopted as the criterion for a fair judicial discretion, indicating the same attitude of the court to the different sides of the dispute, resolving it without giving preference to one of the parties, that is, "neutrality" of the court. In this case, each judge has his own idea of justice discretion. According to V. Ladychenko [8], justice is not so much theoretically realized as it is intuitively perceived, sometimes with the subconscious understanding of it: people seem to consider the correctness of one or another act of the judiciary on the "internal scales" of justice.

The formalization of the decision-making process requires such scientific methods that would provide the opportunity, on the input data collected during the investigation and the pre-trial investigation, to propose the judge a version of the sentence, which is formulated in the subject field language and is the same for all courts of the country.

In the monograph D. Dyadkin [9] developed an algorithmic approach to the definition of a sentence according to the rules of law. The author advocates developing a more formal approach in determining the extent of punishment and reducing the proportion that is determined by the judge's care. D. Dyadkin demonstrates, on the example of assessing the social danger of crime, the possibility of a formal approach,

using fuzzy logical deduction. Another example is the work [10] devoted to the development of a product model in making judgments based on the Mamdani algorithm for the case of moderate causing of serious harm to health.

There is a sufficiently developed theory of fuzzy / linguistic models, which is described in particular in [11]. Such fuzzy / linguistic models that are interpretable and can also be learned from the data. Also, we note that methods of fuzzy mathematics are widely used and are effective in formalizing the knowledge and experience of experts in various fields of human activity, as demonstrated in publications [9-16].

Previously, by the authors of this article in [17], was constructed fuzzy production system based on Sugeno's algorithm. Work was based on the materials of criminal sentences in relation to Part 1 of the Art. 185 of the Criminal Code of Ukraine. But unresolved issues were the choice validity of the fuzzy output algorithm, the study of the impact of different versions of sentences (according to various articles of the Criminal Code of Ukraine) on the complexity of the production rules base.

4 Materials and methods

Legal documents are characterized by a certain structuring and precision of the terminology that uses the terminology of the law. The style of legal documents is marked by the language standardization and unification, the wide use of consistent phrases, stencils, standard texts using. It can be argued that the good interpretation of the fuzzy logical conclusion is determined by the well-established theory of the semantics of the specialized language of the legal branch [11]. Despite this, not all legal terms are subject to formalization, which justifies the choice of fuzzy mathematics methods.

To construct the fuzzy production system, it is necessary to form a base of agreed fuzzy production rules that contain formalized domain experts knowledge. The basic formalism is the notion of a linguistic variable, which meaning can be the words and phrases of the experts specialized natural language. The linguistic variable takes on the term-set value, which elements are the terms given by a fuzzy set with a definite membership function, as described in detail in fundamental labor [11].

During constructing the system and conducting experiments, the authors sought to obtain an approximation of the known sentences values from the source [4], which would allow the source data of the system to be used later as a reference, the basis for sentencing a judge, common to all courts all over the country.

5 Experiments

As can be seen from formula (1), some output variables of common DSS model – *Fine*, *Years* – take numerical values, so it is interesting to compare the possibilities of the most common model of fuzzy logic output from Mamdani algorithm with fuzzy logic output from Sugeno algorithm, which has a clear output the value of some function of the input variables.

Consider the stages of the Mamdani algorithm and the Sugeno algorithm implementations in the Fuzzy Logic Toolbox MatLab [18].

Without losing generalization for greater certainty, we will continue to consider the process of making a judicial decision on the example of art. 185 of the Criminal Code of Ukraine [3], consisting of five parts. To conduct an experiment, choose part 3 of this article, whereby theft, which is associated with penetration into the home, other premises or repository, or which has caused significant harm to the victim, is punishable by imprisonment for a term of 3 to 6 years.

Thus, the general DSS model in court by the formula (1) is transformed for part three of Art. 185 of the Criminal Code of Ukraine concerning theft [3] in the formula, which has the form:

$$\text{Years} = F(\text{Severity}, \text{Personality}, \text{Mitigation}, \text{LM}, \text{Burden}, \text{LB}, \text{Lawyer}), \quad (2)$$

where F is the corresponding fuzzy output algorithm.

Membership functions terms of input and output linguistic variables determined on materials of sentences for criminal case under part 3 of Art. 185 of the Criminal Code of Ukraine. The most successful were the trapezoidal term membership functions for the input variables *Severity*, *Lawyer*, *Mitigation*, *Personality*, *Burden*, and triangular for *LB*, *LM*.

Membership functions terms of input variables are presented in Fig. 1 and Table 2.

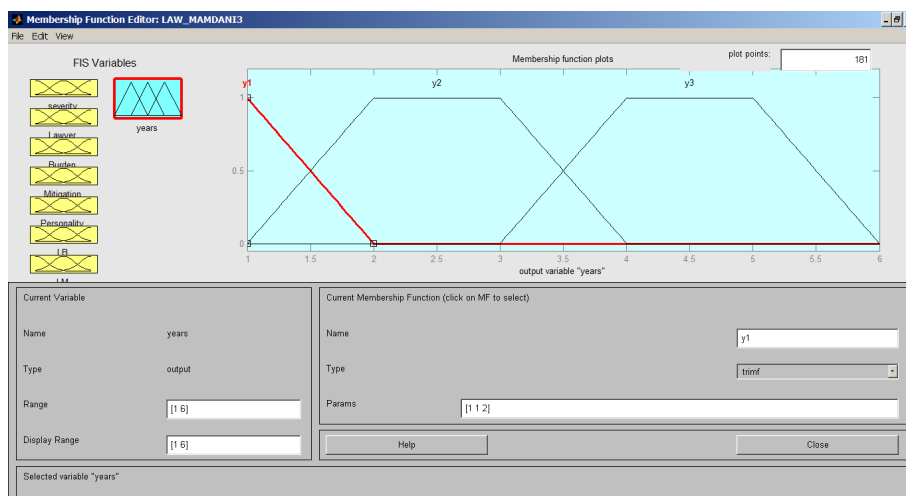

Fig. 1. The membership function of variable outputs on the Mamdani algorithm.

The membership functions of the terms of the output variables by the Mamdani algorithm characterizing the years of imprisonment are presented on Fig. 2 and in Table 3.

The membership functions of the output variable *Years* were built on the basis of judicial practice, according to which it is known that the shortest term, which is

appointed according to Part 3 of Art. 185 of the Criminal Code of Ukraine, is one year. The longest term – six years – is a very severe punishment that occurs in court sentences very rarely.

Table 2. DSS input linguistic variables and their terms of membership functions.

Linguistic variables	Terms designation and associated membership functions		
<i>Severity</i>	d1 [0 0 0.6 1.2]	d2 [0.5 1 2 2.5]	d3 [1.8 2.4 3 3]
<i>Personality</i>	Disrepute [0 0 0.4]	Norm [0.14 0.46 0.54 0.86]	Good [0.6 1 1.4]
<i>Mitigation</i>	m1 [0 0 3 4]	m2 [3 5 6 8]	m3 [7 8 11 11]
<i>LM</i>	lm1 [0 0 0.4]	lm2 [0.1 0.5 0.9]	lm3 [0.6 1 1.4]
<i>Burden</i>	b1 [0 0 4 6]	b2 [4 6 8 10]	b3 [8 10 14 14]
<i>LB</i>	lb1 [0 0 0.4]	lb2 [0.1 0.5 0.9]	lb3 [0.6 1 1.4]
<i>Lawyer</i>	Soft [0 0 0.15 0.4]	Middle [0.05 0.4 0.6 0.85]	Hard [0.6 0.85 1 1]

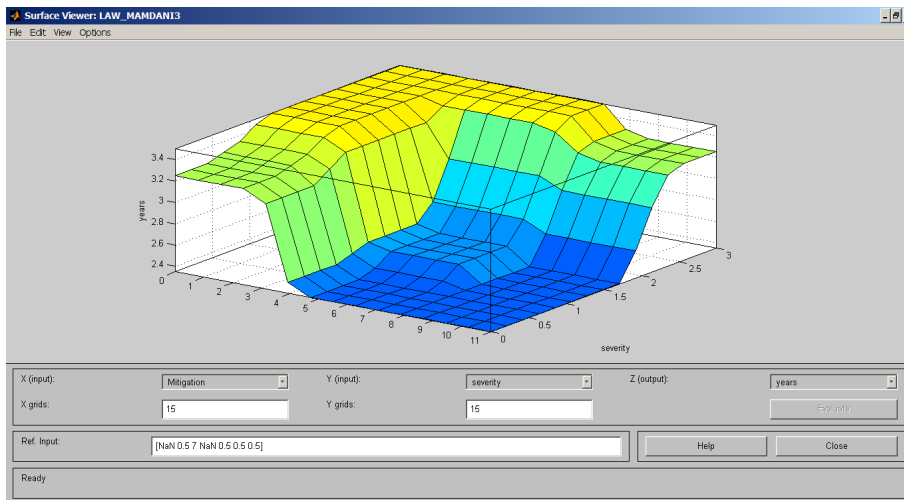

Fig. 2. Surface response to output variable *Years* of input variables *Severity*, *Mitigation*.

Table 3. The output variables of DSS model.

Algorithm	Variable	y1	y2	y3
Mamdani	<i>Years</i>	[1 1 2]	[1 2 3 4]	[3 4 5 6]
Sugeno	<i>Years</i> (linear)	[0.01 0 0.22 -0.144 -0.01 0.1 -0.09 2.9]	[0.01 0 0.22 -0.144 - 0.01 0.1 -0.09 2.9]	[0.01 0 0.22 -0.144 - 0.0 0 -0.0 2.9]

For an example of the DSS work result in Fig. 2 there is a response surface for the Mamdani model for the output variable Years from the input variables Severity, Mitigation.

For the Mamdani algorithm, such fuzzy production rules have been developed: IF the degree of gravity of the offence = big AND the personality = negative AND the mitigation circumstances = from 7 to 11 AND the burdening circumstances = from 8 to 14 AND the level of neutrality of the judge = middle AND the level of the burdening circumstances = big AND the level of the mitigation circumstances = big THEN punishment will be from 1 to 4.

In the case of the Sugeno algorithm, such fuzzy production rules have been developed: IF the level of neutrality of the judge = "middle" THEN the punishment will be y_1 , IF the level of neutrality of the judge = "soft" THEN the punishment will be y_2 , IF the level of neutrality of the judge = "hard" THEN the punishment will be y_3 .

Table 4. Fuzzy Production Rules R_s , $s = 1-28$ for Fuzzy Output System by Mamdani Algorithm.

R_s	Severity	Lawyer	Burden	Mitigation	Personality	LB	LM	Years
1	D1					Lb1	Lm3	Y1
2	D2	middle			norm			Y2
3	D2	soft		M3	norm		Lm3	Y2
4	D3	hard	B3		disrepute	Lb3		Y3
5	D3	middle	B3		good	Lb3		Y2
6		middle	B3	M3	disrepute	Lb1	Lm3	Y2
7		soft		M3			Lm3	Y1
8		hard	B3			Lb3		Y3
9	D3	middle	B3	M3	disrepute	Lb3	Lm3	Y2
10	D3	middle	B3	M1	disrepute	Lb3	Lm1	Y3
11			B3			Lb3		Y3
12				M3			Lm3	Y1
13			B3	M3		Lb3	Lm3	Y2
14	D1							Y1
15	D2							Y2
16	D3							Y3
17		soft						Y1
18		Middle						Y2
19		hard						Y3
20					disrepute			Y3
21					norm			Y2
22					good			Y1
23			B1			Lb1		Y1
24			B2			Lb2		Y2
25			B3			Lb3		Y3
26				M1			Lm1	Y3
27				M2			Lm2	Y2
28				M3			Lm3	Y1

In the case of the Mamdani algorithm, the knowledge base combines 28 production

rules (Table 4), three of which coincide with the basic rules of the Sugeno algorithm. Due to such a number of rules, greater compliance with the non-linearity of the court decision-making process is achieved.

6 Results

In Table 5 and Table 6 summarize the results of the experiment on the DSS developed according to the sentences of six typical cases from the register of court decisions in Ukraine [4].

Table 5. Input data to experiment.

Data on offense by sentence	Input variable	Term value
Case No. 207/2695/17		
repeatedly, with penetration into the home; material damage in the amount of 42059 UAH	<i>Severity</i>	d3=2.5
Reccurence of crime	<i>Burden</i>	b3=5.8
Contrition	<i>Mitigation</i>	m3=7.65
not working, not married, previously sentenced	<i>Personality</i>	Disrepute=0.159
-	<i>LB</i>	lb3=0.635
-	<i>LM</i>	lm3=0.3
Case No. 206/4630/17		
penetration into the home; material damage in the amount of 762.50 UAH	<i>Severity</i>	d1=0.7
not been established by court	<i>Burden</i>	0
not been established by court	<i>Mitigation</i>	0
not working, the place of residence is characterized by a negative; abusing alcohol drinks, not convicted	<i>Personality</i>	Norm=0.5
-	<i>LB</i>	0
-	<i>LM</i>	0
Case No. 315/1155/17		
penetration into another room, material damage for 290 UAH	<i>Severity</i>	d1=0.2
committing a crime in a state of intoxication	<i>Burden</i>	b3=1
sincere repentance and active assistance in the disclosure of the crime	<i>Mitigation</i>	m3=1
not married, not working, inclined to drink alcohol, inclined to persistent criminal activity, not convicted	<i>Personality</i>	Disrepute=0.4
-	<i>LB</i>	lb3=0.5
-	<i>LM</i>	lm3=0.3
Case No. 127/14282/16-k		
repeatedly, with penetration into the home; material damage in the amount of 4131.70 UAH	<i>Severity</i>	d3=2.5
recidivism of a crime	<i>Burden</i>	b3=5.8
contrition	<i>Mitigation</i>	m3=7.65
not working, married, before convicted	<i>Personality</i>	Disrepute=0.2
-	<i>LB</i>	lb3=1
-	<i>LM</i>	lm3=0.1
Case No. 161/13758/17		

Data on offense by sentence	Input variable	Term value
got into the territory of the house; material damage in the amount of 516.15 UAH	<i>Severity</i>	d1=0.7
committing a crime in a state of intoxication	<i>Burden</i>	b3=1
sincere repentance and active assistance in the disclosure of the crime	<i>Mitigation</i>	m3=1
not married, not working, before convicted	<i>Personality</i>	Disrepute=0.25
-	<i>LB</i>	lb3=0.5
-	<i>LM</i>	lm3=0.3
Case No. 311/2510/17		
repeatedly, combined with penetration into the home; property damage for the total amount of UAH 10800.28+ UAH 8527	<i>Severity</i>	d2=2.3
not been established by court	<i>Burden</i>	0
acknowledged guilty completely, repentantly	<i>Mitigation</i>	m3=1
not married, not working, before convicted	<i>Personality</i>	Norm=0.5
-	<i>LB</i>	0
-	<i>LM</i>	lm3=0.3

Table 6. Comparison of judgments and decisions made by the DSS for the output variable *Years*.

Case No.	Term of imprisonment by court sentence	Algorithm	DSS recommendation	Deviation
207/2695/17	3 years and 3 months (3.25)	Mamdani	3.25	0
		Sugeno	3.17	-0.08
206/4630/17	3 years	Mamdani	3.25	+0.25
		Sugeno	2.9	-0.1
315/1155/17	3 years	Mamdani	3.25	+0.25
		Sugeno	3	0
127/14282/16-k	3 years 6 months (3.5)	Mamdani	3.5	0
		Sugeno	3.1	-0.4
161/13758/17	4 years (with the establishment of probation 2 years)	Mamdani	3.25	-0.75
		Sugeno	3	-1.0
311/2510/17	4 years (Punishment with dismissal on the basis of Art. 75 of the Criminal Code of Ukraine with the establishment of probation 3 years)	Mamdani	3.25	-0.75
		Sugeno	2.75	-1.25

In all cases, given in Table 5, it was considered that the decision is made by a fair judge, that is, the input variable Lawyer takes the value *Middle* with the corresponding value of the membership function 0.5.

The Mamdani algorithm for the first four cases presented in Table 6, has generated the punishment that is either coincidental or more severe on 0.25 years than was pronounced by a court sentence. The Sugeno algorithm in these cases showed an absolute deviation of -0.4 to 0 years, with reducing the term of imprisonment.

For the last two cases from Table 6 both Mamdani and Sugeno algorithms generated milder punishment compared with the term of imprisonment by court decision. This is

due to the influence of the more complex content of the sentence, which contains a reference to other articles of the Criminal Code of Ukraine. Reduce or avoid this discrepancy maybe the complication of the model (2) with the additional Condition provided in the general model (1).

7 Discussion

When substantiating the choice of fuzzy output algorithm, it is necessary to take into account possible errors in the generated solutions and the complexity of calculations by the chosen algorithm. Similar questions were raised for an individual case of approximation of the continuous function of one variable in the work [13].

At the level of the conducted experiment, both systems of fuzzy logic output Mamdani and Sugeno showed the adequacy of the generated results of sentences without the apparent advantage of one of the algorithms. But the linearity of the output functions of the Sugeno algorithm provides a more simple setup of the fuzzy output system and yields a gain from a computational point of view.

Both systems responded equally to the existence of additional conditions, which in practice proved to be mitigating of the court decision. This is confirmation of the need to introduce qualitative, non-numeric parameters to the system's input. The introduction of such variables is more convenient in the system of fuzzy logic output using the Mamdani algorithm.

The following steps of improving DSS in the courts are dictated by the need of developing unified rules for initializing input variables, which will allow adjusting fuzzy production models to obtain the fair verdict in cases involving the crime in several parts of one article and / or several different articles of the Criminal Code of Ukraine.

8 Conclusions

The scientific novelty of the work determines the general model construction of the decision support system in court as fuzzy production system, as well as a cycle of experiments with the developed DSS on the basis of real data on convictions on cases from the database of the Unified State Register of Court Solution in Ukraine.

The practical value of this work is that the use of fuzzy logic methods is potentially productive to support fair court decisions, since it allows one to approach the formalization of the notion of fair court decision.

It appears perspective to introduce such subsystem into the system of the Single Judicial Information and Telecommunication System (SJITS) – “Electronic Court”, which testing was started in 18 pilot courts of Ukraine from 04.06.2018, is considered. This will increase the level of automation of routine moments of judicial practice, bring the information society closer.

9 Acknowledgements

The work was carried out as the part of the research work “Mathematical modeling of socio-economic processes and systems”, the registration number DB05038, at the Department of System Analysis and Computational Mathematics of Zaporizhzhya National Technical University.

References

1. Prosecutor General’s Office of Ukraine. <https://www.gp.gov.ua> (2019). Accessed 27 Mar 2019
2. Kasnachejeva D.V.: Zlochynnist’ koryslyva nenasylnyc’ka (Criminality is mercenary non-violent). In: Cherniy, V.V., Sokurenko, V.V. (eds.) Ukrainian Criminological Encyclopedia, pp. 264–267. Golden mile, Kharkiv-Kiev (2017)
3. Criminale code of Ukraine. <https://zakon.rada.gov.ua/laws/show/2341-14> (2019). Accessed 27 Mar 2019
4. Unified State Register of Court Decisions in Ukraine. <http://www.reyestr.court.gov.ua> (2019). Accessed 27 Mar 2019
5. Clark, C.E.: The Limits of Judicial Objectivity. *The American University Law Review*. **12**, 1–13 (1963)
6. Convention for the Protection of Human Rights and Fundamental Freedoms. http://zakon2.rada.gov.ua/laws/show/995_004 (2019). Accessed 27 Mar 2019
7. Tobota, Yu.A.: Ponyattya ta kryteriyi “spravedlyvoho sudovoho rozhlyadu” u rishennyakh yevropeyskoho sudu z prav lyudyny (Conception and criteria of “fair legal process” in judgements of European Court of Human Rights). *Visnyk Kharkivs’koho natsional’noho universytetu imeni V. N. Karazina*. 1086, 65–68 (2013)
8. Ladychenko, V.: Instytutshizatsiya spravedlyvosti v protsesi derzhavotvorenniya (Institutionalization of justice in the process of state-building). *Yuryd. Ukraine*. 6, 4–9 (2006)
9. Dyad’kin, D. S.: Teoreticheskiye osnovy naznacheniya ugolovnoho nakazaniya: algoritmicheskyy podkhod (Theoretical foundations of criminal penalties: an algorithmic approach). Izd-vo R. Aslanova “Yuridicheskyy tsentr press”, Sankt-Peterburg (2006)
10. Kharchenko, T.Yu., Voronina, I.Ye.: Produktsionnaya model’ v prinyatii sudebnykh resheniy (Production model in judicial decisions). *Vestnik VGU, Seriya: Sistemnyy analiz i informatsionnyye tekhnologii*. 1, 142–148 (2018)
11. Nov’ak, V., Perfilieva, I., Dvor’ak, A.: *Insight of Fuzzy Modeling*. Wiley & Sons, Hoboken (2016)
12. Lande, D.V., Furashev, V.M.: *Osnovy informatsiynoho i sotsialno-pravovoho modelyuvannya (Fundamentals of information and socio-legal modeling)*. Pantot, Kyiv (2012)
13. Kruglov, V.V.: Sravneniye algoritmov Mamdani i Sugeno v zadache approksimatsii funktsii (Comparison of Mamdani and Sugeno algorithms in the function approximation problem). *Neyrokomp.: razrobotka, primeneniye*. 5, 70–82, (2003)
14. Oleynik, A.A., Subbotin, S.A.: Reduktsiya baz nehotkikh pravil na osnove mul’tiagentnogo podkhoda (The fuzzy rule base reduction based on multiagent approach). *Vestnik NTU “KHPI”*. 43, 126–137 (2009)

15. Shitikova, Ye.V., Tabunshchik, S.S., Tabunshchik, G.V.: Metod formirovaniya ob'yema rabot dlya programm ispytaniy na osnove nechetkogo vyvoda (Method for forming test workflow based on fuzzy inference). *Radioelektronika, informatika, upravleniye*. 2, 162–168 (2018)
16. Shtovba, S.D.: *Proyektirovaniye nechetkikh sistem sredstvami MATLAB (Fuzzy systems design with MATLAB)*. Telekom, Moskva (2007)
17. Bakurova, A.V., Tereshchenko, E.V., Pasichnyk, M.S.: Alhorytm Sugeno u systemi pidtrymky pryynyattya sudovykh rishen (Support System for Making Judicial Decisions Based on Sugeno Algorithm). In: Abstracts of the International scientific and practical conference “Information technologies and computer modeling”, Ivano-Frankivsk, 14-19 May 2018, pp. 830–834 (2018)
18. Academic version of MATLAB. <https://uk.mathworks.com/campaigns/products/trials.html> (2019). Accessed 27 Mar 2019
19. Bakurova, A., Pasichnyk, M., Tereshchenko, E., Filei, Y.: Production model for administration of judicial decisions in the case of theft. *SHS Web of Conferences*. 65, 04012 (2019). doi:10.1051/shsconf/20196504012

Information System for Monitoring Banking Transactions Related to Money Laundering

Serhiy Leonov^[0000-0001-5639-3008], Hanna Yarovenko^[0000-0002-8760-6835],
Anton Boiko and Tetiana Dotsenko

Sumy State University, 2, Rymkoho-Korsakova Str., Sumy, 40000, Ukraine Sumy, Ukraine
slyeonov@gmail.com, a.yarovenko@uabs.sumdu.edu.ua,
antonboyko11@gmail.com, tvdocenko85@gmail.com

Abstract. The article deals with the prototyping of an information system for intrabank monitoring of transactions related to money laundering. It has been proven that the automation of financial monitoring system would increase the bank's efficiency due to examining all bank transactions without exception, leveling the human factor, maximizing the speed of identifying suspicious transactions, which will provide the bank management with the possibility to reduce reputational risk and minimize losses related to paying penalties imposed by regulatory agencies. It has been established that the prototype of the information system for monitoring transactions related to money laundering through banks should consist of a model of the business process monitoring in an automated system environment, a DFD model of automated monitoring of banking transactions, a structural database model, user interface forms and the logic of validation business rules. The resulting methodological and practical developments are a universal component of the financial monitoring system of any bank since they have the opportunity to transform and adapt to new standards for reporting entities or differentiation of the business processes of a bank.

Keywords: money laundering, intrabank monitoring, information system.

1 Introduction

The problem of countering the shadow economy is relevant for Ukraine since its independence. According to the Ministry of Economic Development and Trade of Ukraine, the level of the shadow sector was in the range of 32-43% of GDP in the period from 2010 to 2018 [1]. This share is confirmed by the FATF studies, which determine the value of the shadow sector in the range of 20-40% of GDP for transition economies [2]. It is fair to note that a significant part of the shadow sector in Ukraine is formed as a result of money laundering.

Given the fact that the financial system of Ukraine is bank-centered, the main participants in money laundering are banks. Thus, according to the State Financial Monitoring Service of Ukraine, the number of reports of suspicious financial transactions recorded in 2017 was 8,013,500 (by 26.8% more than in 2016), and 99% of these reports were generated by banks. At the same time, we note that more than

90% of financial transactions of records taken by the State Financial Monitoring Service belong to compulsory financial monitoring [3]. Thus, the requirements of state regulators lead to the identification of suspicious transactions, and the system of internal financial monitoring of banks is ineffective.

Thus, the formation of an autonomous, quick response and multi-functional intrabank financial monitoring system becomes relevant. The solution of this task is proposed to be implemented through the prototyping of an information system for monitoring transactions related to money laundering through banks.

2 Literature Review

The world scientific community pays considerable attention to the study of the peculiarities of banking transactions related to money laundering. Thus, the place of banks among other money laundering tools is highlighted in the works by P. He [4], M. Betron [5], B. Unger [6]. These scientists determine the important role of banking transactions among all other money laundering methods and emphasize the need for active counteraction to these illegal actions, both inside the bank and at the level of state regulation. Moreover, scientists determine the continuing trend of growth in the funds that were laundered through the financial system.

Other group of scientists J. Simser [7], A. Chong, F. Lopez-De-Silanes [8], D. Sat et al. [9] and F. Teichmann [10] study the prospects of using different money laundering tools. Scientists concluded that despite the active use of the latest technologies (cryptocurrency) for illegal activity, banks in certain regions of the world would remain a very relevant money laundering tool.

Finance Stability Board [11], Y. Isa et al. [12], and E. Tsingou [13] studied the issue of financial monitoring in banks and the peculiarities of counteraction to the use of bank transactions for money laundering. These studies are focused on highlighting the mechanisms used in various banks worldwide to counteract the use of their transactions for money laundering, as well as the role of bank staff in this process. In parallel, the authors emphasize the need for state regulators to intensify the internal banking system of financial monitoring by developing appropriate coercive regulatory legal acts.

Exploring existing research on the role of information systems in detecting fraud in the financial sector, we note that E. Karuppiyah et al. [14] generalized the basic machine learning techniques for the preparation, processing and transformation of data related to money laundering.

In addition, it is necessary to pay attention to some more scientific works. Thus, V. Pramod, J. Li, P. Gao [15] proposed a new structure for the prevention of money laundering in banks formed by mapping COBIT (Control for Information and Related Technology) processes to the COSO (Committee of Sponsoring Organization) components. In turn, S. Gao, D. Xu, H. Wang, P. Green [16] proposed to use the intelligent agents technology to increase the flexibility of managerial decisions in the field of banking monitoring. Thus, the authors have developed a multi-agent framework in the form of a stand-alone system, which can be integrated into the business processes of a bank and will detect transactions related to money laundering.

Scientific paper by E. Divya, P. Umadevi [17], which deals with the Transaction Flow Analysis (TFA) system, deserves attention. The proposed information model implies the identification of banking transactions, which are not bound to any file format, and their subsequent clustering in terms of the probability of being associated with money laundering.

3 Findings

When studying the features of the prototyping of the information system for intrabank financial monitoring, we note that the process of identifying transactions related to money laundering is quite arduous, periodic in nature, significantly dependent on personnel decisions, but well formalized. Therefore, we analyze the existing system of intrabank financial monitoring, which was developed using BPMN 2.0 notation [18] and Bizagi Studio [19] (Fig. 1).

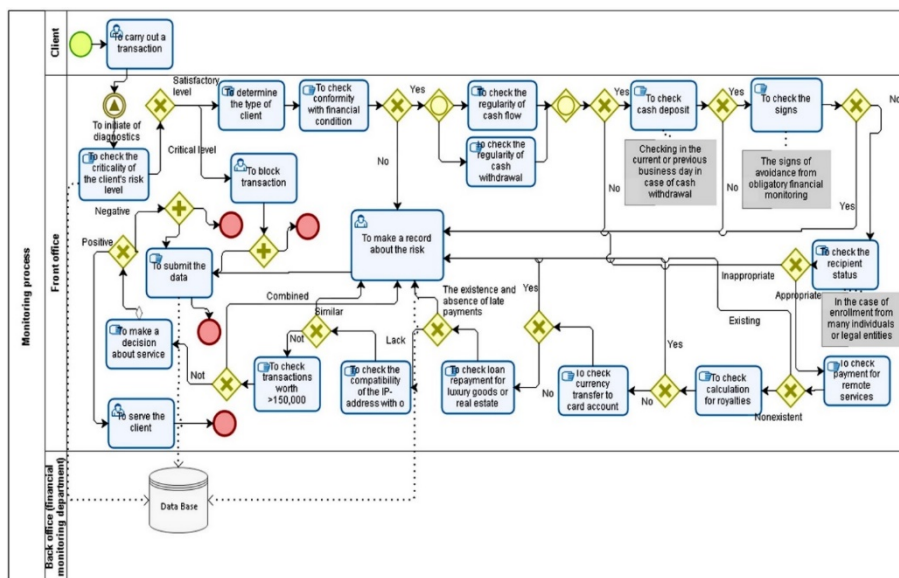

Fig. 1. Diagram of the existing intrabank monitoring business process.

Thus, the identification of the risk related to using bank services for money laundering consists in assessing the sources of income received by the entity or individual. Thus, we check:

- compliance of the funds credited to a bank account with the financial status of the client;
- regularity of receipt of funds, and further cash withdrawals;
- signs of evasion from the mandatory financial monitoring procedure on the part of a client;

- status of a beneficiary in the case of crediting funds from many individuals or legal entities;
- payment by the client for remote services;
- payment of the royalty fee, crediting foreign currency to the card account of the client;
- paying off client's loan for elite goods or real estate;
- similar IP-addresses of client transactions with other transactions;
- transactions exceeding 150,000 UAH.

After each verification, the transaction risk record is entered into the database.

Thus, there are the following shortcomings of the existing system for financial monitoring of risks related to using bank services for money laundering:

- the absence of a unified system of obligatory transactions, which, depending on the level of their regulation by a particular regulatory legal act, are mandatory or recommended;
- all transactions are carried out manually by a bank employee, requiring the appropriate competence and a considerable amount of time;
- the introduction of a transaction into the risk operations base occurs at the discretion of the banking specialist, which renders impossible a high level of impartiality of the assessment;
- risk assessments of money laundering are not conducted by the bank employees during each transaction. Definition of suspicious transactions is carried out periodically depending on the risk level of the client, depending on the suspicion of the specialist in accordance with the client's transactions or in accordance with the requests of the back office employees.

Thus, an effective solution to the problems of low efficiency of the intrabank system for financial monitoring of risks associated with money laundering is the use of information technologies. Domestic banks do not have such systems due to the specifics of the subject area. Therefore, we propose to create a prototype of an automated system for financial monitoring of banking transactions. For this purpose, the team of authors improved the existing bank monitoring process, taking into account the possibility of its automation. Figure 2 is a diagram of the improved business process of financial monitoring, which was developed using BPMN 2.0 notation [18] and Bizagi Studio [19].

Considering the data presented in Figure 2, it can be argued that the automated system, instead of the employees of the bank front office, should deal with the main actions related to the verification of suspicious transactions. This will allow unloading the front office managers regarding verification of potential transactions related to money laundering. Their automation will assist in improving the efficiency of the bank staff during the implementation of financial monitoring. Namely, first, it will allow for constant online verification. Secondly, the situation of the employee's impact on the verification process and concealing or distorting its results will no longer be possible. This will occur because the system provides for the application of business rules logic that will assist in the automatic selection of those transactions that do not meet the specified conditions. An administrator is responsible for their settings, and other bank

employees will not be able to purposefully influence the verification process. Thirdly, such a system allows verifying a larger volume of transactions concerning their involvement in money laundering and terrorism financing. Since monitoring is necessarily applied to transactions, for example, the amount of which exceeds UAH 150,000, transactions with lower amounts, which may also have criminal sources of origin, remain without attention. The use of an automated system will facilitate the verification of all transactions, regardless of their amount. Fourthly, the advantage of the proposed solution is the flexibility of setting up this system in case of changes in legislation or the provisions of the National Bank of Ukraine and bank instructions for verifying such transactions. This is possible due to changes in the parameters of business rules used to verify transactions.

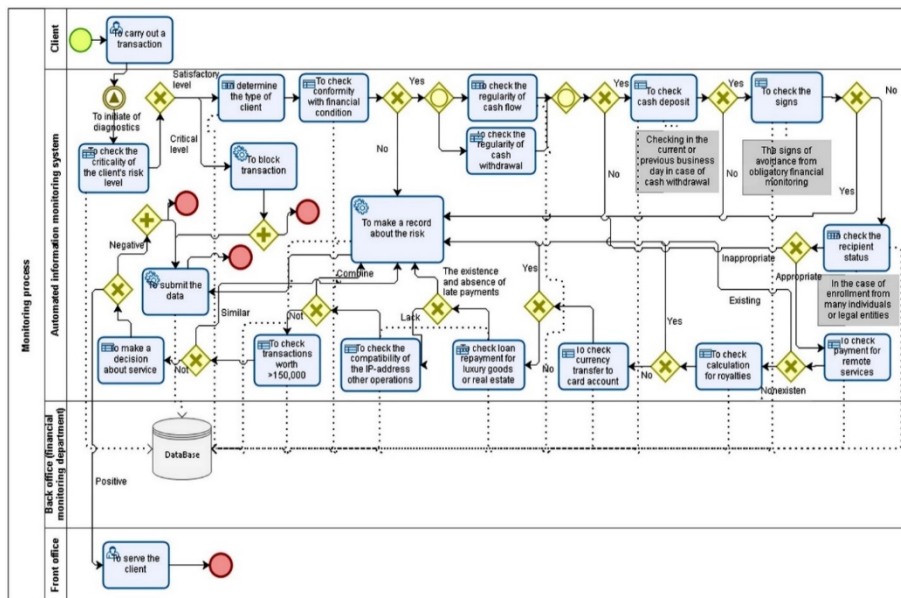

Fig. 2. The monitoring business process model in an automated system environment.

When designing an intrabank financial monitoring system, it is important to build an information model that provides insight into the interconnections between the system objects and their structure. For this purpose, based on the proposed business process (Figure 2), the authors developed an information model based on the Structured Analysis and Design Technique (SADT) in the DFD (Data Flow Diagrams) notation. The authors chose this methodology due to its capabilities of the description of data flows, taking into account their interaction in the process of manual and automated processing of information. Thus, Figure 3 shows the result of this simulation – the DFD-model of financial monitoring of banking transactions performed in the software environment All Fusion Process Modeller [20].

The proposed model includes the following main entities, such as “Bank Client” and “Front Office Manager”, 14 main functions related to the verification of banking transactions concerning their use in money laundering or terrorist financing, and 8 basic structures for storing information. Input and output streams of information are defined between the presented objects.

The functions 1-13 from Figure 3 show the main areas of monitoring: the first verification the criticality of the client’s risk level, the second verification the type of client, the third verification conformity with financial condition, the fourth verification the regularity of cash flow and cash withdrawal, the fifth verification the signs of avoidance from obligatory financial monitoring, the sixth verification the cash deposit, etc. In these areas, there are transactions identified as if there is a risk of money laundering. The results of verifications are accumulated in the block “Make a decision” where the decision is made on whether there is a risk on a transaction or there is no risk.

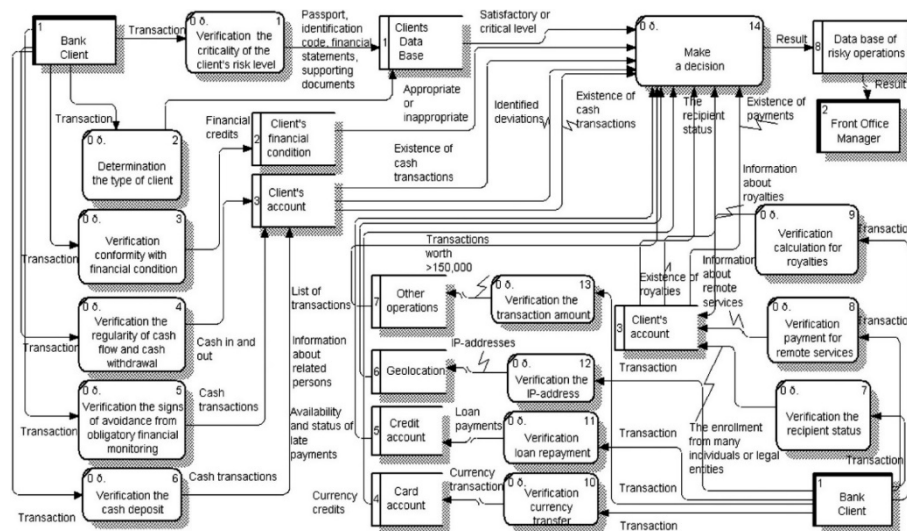

Fig. 3. DFD-model of automated monitoring of banking transactions.

Understanding information about incoming and outgoing streams is very important. Since the main subject of monitoring is a client transaction, it is verified by comparing with the criteria. As criteria, a bank can use the client’s financial documentation, loan payments, information about payments for expensive purchases, transactions that do not correspond to the client’s type of activity, information about payments of author’s fees, the IP-address of the operation, etc. This information is usually contained in an automated banking system, where the automated financial monitoring module will be integrated.

The developed DFD-model formed the basis for the creation of a logical data scheme, which implementation allowed forming the internal information system of the system prototype. For this purpose, entities were created, relationships were established, relations types were selected, and attributes were specified. Thus, a

complete data structure was created to develop a database of automated monitoring system, which was developed using Bizagi Studio [19] (Figure 4).

The proposed model (Figure 4) identifies a structured database model running SQL Server that determines how data is available, stored and used in the system. The value of the model lies in the fact that it takes into account the main specificity of monitoring transactions in the bank.

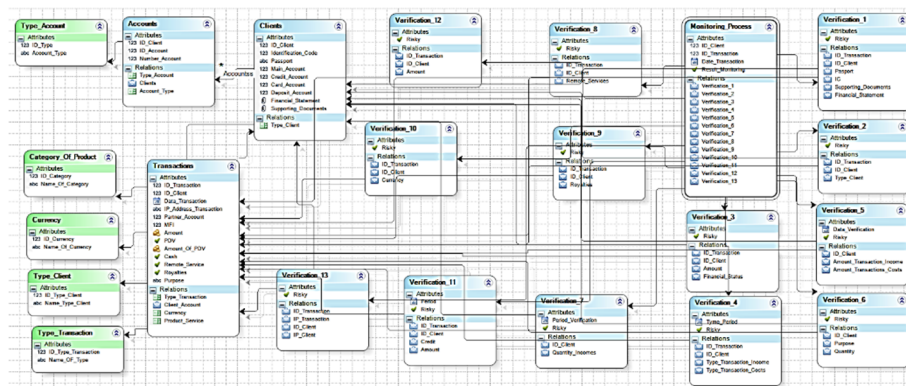

Fig. 4. Database structural model of automated monitoring system.

The next step in developing the system prototype is the development of interfaces and the definition of basic business rules. Thus, the user interface forms have been developed that allow seeing how the user will interact with the system. Since the proposed system carries out the entire verification process without the employee's participation, the verification results form were created (Figure 5).

The developed form allows us to get information about the client, the transaction and the results of the monitoring according to thirteen rules. Only two options were proposed for each risk position. The system gives the option "YES" if there is a risk of a transaction. The system issues "NO" in the absence of risk. The information system also allows us to get a general result of monitoring. The "YES" answer will indicate the presence of risk at any level of verification and a transaction will be rejected. If there is no risk at all levels of monitoring, the system will give the answer "NO" and a transaction will be accepted.

For automatic execution of actions, the system has developed basic business verification rules. These rules are important for the further development of the automated system. The development of the rules was carried out according to the following logic, represented by the formulas 1-3.

To conduct monitoring, there are next business rules (Formulas 1-2):

$$\text{IF [Condition of Verification}_1 \neq \text{Criteria of Verification}_1] \\ \text{THEN [Risk = 1] ELSE [Risk = 0]} \quad (1)$$

...

IF [Condition of Verification_N ≠ Criteria of Verification_N]
THEN [Risk = 1] ELSE [Risk = 0], (2)

where *Condition of Verification₁* – a condition for verifying a transaction for a certain type of risk that corresponds to the first function of Figure 3; *Condition of Verification_N* – a condition for verifying a transaction for a certain type of risk that corresponds to one of the functions of Figure 3 (as an example, it is the condition of verification the signs of avoidance from obligatory financial monitoring); *N* – a number of verifications from 1 to 13; *Criteria of Verification₁* – the first criterion that is chosen to verify the transaction for the risk of money laundering; *Criteria of Verification_N* – the criteria 2-13 that is chosen to verify the transaction for the risk of money laundering (as an example, it is the criterion that corresponds to the information about client's cash transactions on him account); *Risk = 1* – presence of money laundering transaction risk; *Risk = 0* – lack of money laundering transaction risk.

Client's ID:	<input type="text" value="123"/>
Transaction ID:	<input type="text" value="123"/>
Date of Transaction:	<input type="text" value="M/d/yyyy"/>
The criticality of the client's risk level:	<input checked="" type="radio"/> Yes <input type="radio"/> No
The risk of client type:	<input checked="" type="radio"/> Yes <input type="radio"/> No
The risk of inconsistency the financial condition:	<input checked="" type="radio"/> Yes <input type="radio"/> No
The risk of income irregularity:	<input checked="" type="radio"/> Yes <input type="radio"/> No
The risk of inconsistency client's cash flow:	<input checked="" type="radio"/> Yes <input type="radio"/> No
The risk of evading financial monitoring:	<input checked="" type="radio"/> Yes <input type="radio"/> No
The risk of enrollment from a large number of partners:	<input checked="" type="radio"/> Yes <input type="radio"/> No
The remote services risk:	<input checked="" type="radio"/> Yes <input type="radio"/> No
The royalties risk:	<input checked="" type="radio"/> Yes <input type="radio"/> No
The currency risk:	<input checked="" type="radio"/> Yes <input type="radio"/> No
The loan default risk:	<input checked="" type="radio"/> Yes <input type="radio"/> No
The risk of IP-addresses incompatibility:	<input checked="" type="radio"/> Yes <input type="radio"/> No
The risk of exceeding the amount of 150.000 UAH:	<input checked="" type="radio"/> Yes <input type="radio"/> No
Result of Monitoring:	<input checked="" type="radio"/> Yes <input type="radio"/> No

Fig. 5. User interface form with results of verification.

To obtain the overall monitoring result, the following business rule is set (Formula 3):

IF [Verification₁ = 1 OR Verification₂ = 1 OR Verification₃ = 1 OR Verification₄ = 1 OR Verification₅ = 1 OR Verification₆ = 1 OR Verification₇ = 1 OR Verification₈ = 1 OR Verification₉ = 1 OR Verification₁₀ = 1 OR Verification₁₁ = 1 OR Verification₁₂ = 1 OR Verification₁₃ = 1] THEN ["YES" Risk AND Reject operation] ELSE ["NO" Risk AND Accept Operation], (3)

where *Verification_{1,2,...,13}* – the result of each verification; "YES" Risk AND Reject operation – the decision when the risk of money laundering is present and the transaction is rejected; "NO" Risk AND Accept Operation – the decision when there is no risk of money laundering and the transaction is accepted.

The developed rules constitute a group “Define Expressions”, determining the behavior of the system under certain conditions. Thus, the rules take into account branching conditions that correspond to a positive verification result when the transaction is not at risk related to money laundering or negative when the transaction is entered into the database of risky operations and blocked by the system.

4 Conclusion

It is fair to note that despite the fact that the problem of assessing the risk related to using banks for money laundering or terrorism financing is not a priority, but its solution is extremely important both for banks and for the state as a whole. Thus, over the past five years, the rate of money laundering through banking transactions significantly exceeds the rate of economic growth in Ukraine. In turn, for banks, the risks are manifested in the strengthening of supervision on the part of the National Bank of Ukraine, increased motivation of bank staff to fraud and the future loss of financial stability.

Banks, as entities of initial financial monitoring, should analyze client's transactions to identify the features that are typical for the laundering of money obtained illegally. As part of this activity, they can only detect these operations by post factum. Practical experience of Ukrainian banks shows that financial monitoring is periodic, non-systematic, carried out manually, its results can be influenced by the “human factor”, which is a manifestation of a corrupt component. But the main task of monitoring is to prevent transactions which there is a risk of money laundering with. Therefore, the prototyping of an information system for monitoring banking transactions related to money laundering is a very topical issue.

Thus, a prototype of an automated system for financial monitoring of transactions was obtained to find their connection with money laundering. The prototype consists of a monitoring business process model in an automated system environment, a DFD automated banking monitoring model, a database structural model, user interface forms and validation business rules logic.

The application of the proposed information system allows us to verify the client's transactions on the thirteen risk rules. This approach makes it possible to assess the risk of money laundering for each transaction. If an operation does not correspond at least one rule, then it is rejected. The system concludes that there is an increased risk of this transaction. Because of the automatic process, the influence of bank employees on risk transactions is excluded. Furthermore, the front-office worker can make a decision based on information obtained from the information system.

The implementation of the proposed system will automate the monitoring process, reduce its labor intensity, increase the efficiency of verification by processing more transactions, and shift the focus from the employee to the automated system to reduce the impact on the verification results.

In the future it is planned to implement the proposed prototype into the practical activity of banks at the level of subjects of initial financial monitoring. Since this implementation involves the necessity to optimize the monitoring business process in

a bank, it requires a considerable amount of time. In today's conditions of intensifying the struggle with the problem of money laundering, the interest of banks in this decision is unconditional. Under the influence of regulation of this problem by the National Bank of Ukraine, the implementation by banks an automated monitoring system will contribute to the creation of a unified information base of monitoring and information integration at the level of subjects of state monitoring.

5 Acknowledgements

The article was executed in the framework of state budget scientific research work No. 0118U003574 “Cyber security in the fight against bank fraud: protection of financial services consumers and growth of financial and economic security of Ukraine” and scientific research work No. 0117U002251 “Improvement of national anti money laundering system in terms of increasing financial and economic security of the state”.

References

1. Ministry of Economic Development and Trade of Ukraine. <http://www.me.gov.ua/?lang=en-GB> (2018). Accessed 20 Feb 2019
2. FATF-GAFI.ORG - Financial Action Task Force (FATF). <http://www.fatf-gafi.org> (2019). Accessed 20 Feb 2019
3. The State Financial Monitoring Service. <http://www.sdfm.gov.ua/index.php?lang=en> (2018). Accessed 20 Feb 2019
4. He, P.: A typological study on money laundering. *Journal of Money Laundering Control*. **13**(1), 15–32 (2010). doi:10.1108/13685201011010182
5. Betron, M.: The state of anti-fraud and AML measures in the banking industry. *Computer Fraud & Security*. **2012**(5), 5–7 (2012). doi:10.1016/S1361-3723(12)70039-8
6. Unger, B.: Can Money Laundering Decrease? *Public Finance Review*. **41**(5), 658–676 (2013). doi:10.1177/1091142113483353
7. Simser, J.: Money laundering: emerging threats and trends. *Journal of Money Laundering Control*. **16**(1), 41–54 (2012). doi:10.1108/13685201311286841
8. Chong, A., Lopez-De-Silanes, F.: Money laundering and its regulation. *Economics & Politics*. **27**(1), 78–123 (2015). doi:10.1111/ecpo.12051
9. Sat, D.M., Krylov, G.O., Bezverbnyi, K.E., Kasatkin, A.B., Kornev, I.A.: Investigation of money laundering methods through cryptocurrency. *Journal of Theoretical and Applied Information Technology*. **83**(2), 244–254. <http://www.jatit.org/volumes/Vol83No2/11Vol83No2.pdf> (2016). Accessed 21 Mar 2019
10. Teichmann, F.M.J.: Twelve methods of money laundering. *Journal of Money Laundering Control*. **20**(2), 130–137 (2017). doi:10.1108/jmlc-05-2016-0018
11. Finance Stability Board: Global Shadow Banking Monitoring Report 2014. http://www.fsb.org/wp-content/uploads/r_141030.pdf (2014). Accessed 21 Mar 2019
12. Isa, Y.M., Sanusi, Z.M., Haniff, M.N., Barnes, P.A.: Money Laundering Risk: From the Bankers' and Regulators Perspectives. *Procedia Economics and Finance*. **28**, 7–13 (2015). doi:10.1016/s2212-5671(15)01075-8
13. Tsingou, E.: New governors on the block: the rise of anti-money laundering professionals. *Crime, Law and Social Change*. **69**(2), 191–205 (2018). doi:10.1007/s10611-017-9751-x

14. Karuppiah, E.K., Lam, K.S., Chen, Z., Van Khoa, L.D., Teoh, E.N., Nazir, A.: Machine learning techniques for anti-money laundering (AML) solutions in suspicious transaction detection: a review. *Knowledge and Information Systems*. **57**(2), 245–285 (2018). doi:10.1007/s10115-017-1144-z
15. Pramod, V., Li, J., Gao, P.: A framework for preventing money laundering in banks. *Information Management & Computer Security*. **20**(3), 170–183 (2012). doi:10.1108/09685221211247280
16. Gao, S., Xu, D., Wang, H., Green, P.: Knowledge-based anti-money laundering: A software agent bank application. *Journal of Knowledge Management*. **13**(2), 63–75 (2009). doi:10.1108/13673270910942709
17. Divya, E., Umadevi, P.: Money laundering detection using TFA system. In: International Conference on Software Engineering and Mobile Application Modeling and Development (ICSEMA 2012), 19-21 Dec. 2012 (2013). doi:10.1049/ic.2012.0150
18. BPMN Specification - Business Process Model and Notation. <http://www.bpmn.org> (2019). Accessed 20 Feb 2019
19. Bizagi Studio Process Automation & Workflow Software - Free Download. <https://www.bizagi.com/en/products/bpm-suite/studio> (2019). Accessed 20 Feb 2019
20. BPWin Software Download. BPM Microsystems. <https://bpmmicro.com/support/software/downloads> (2019). Accessed 20 Feb 2019
21. Leonov, S., Yarovenko, H., Boiko, A., Dotsenko, T.: Prototyping of information system for monitoring banking transactions related to money laundering. *SHS Web of Conferences*. **65**, 04013 (2019). doi:10.1051/shsconf/20196504013

Modeling state regulation of the labour market

Valery Heyets^[0000-0002-2895-6114]

Institute for Economics and Forecasting, 26, Panasna Myrnogo Str., Kyiv, 01011, Ukraine
heyets@nas.gov.ua

Mykhaylo Voynarenko

Khmelnytsky National University, 11, Instytutska Str., Khmelnytsky, 29016, Ukraine
voynarenko@ukr.net

Anatoliy Kholodenko^[0000-0001-7626-5820] and Nina Stepanok

Odesa National Maritime University, 34, Mechnykova Str., Odesa, 65029, Ukraine
anathol2035@gmail.com, Gluk_@ukr.net

Abstract. The purpose of this article is to justify the necessity for state regulation of the labour market. Various options for setting wages at the state level, trade unions and employers are considered. It is shown the expediency of state regulation of the labour market in order to ensure the optimal level of employment. It has been established that the maximum tax base and the highest level of employment are achieved simultaneously, with the same optimal level of remuneration. None of these goals can be achieved separately from the other.

Keywords: labour market, state's regulation, optimal level of employment, wages, employers.

1 Introduction

Unemployment is one of the most acute social and economic problems. A high level of unemployment indicates a low level of supply of goods, because when the amount of capital and are specified, production depends on the amount of labour resources used. At the same time, excessive unemployment is the cause of the low level of consumer demand, which also leads to the formation of disproportions in the economy. The minimum unemployment is one of the criteria of a developed economy, therefore, the problem of studying the characteristics of the labour market and the formation of wages is very relevant.

The article [1] shows the rising relevance of the institutional theories for the labour market economics. The paper [2] develops a New Keynesian model with labour search and investigates the effects of product and labour market regulation on macroeconomic outcomes. The paper [3] explores the influence of labour market institutions on aggregate fluctuations. The article [4] reviews concepts and theories regarding economic balance in incidence with the labour market. In paper [5] is estimated a

dynamic stochastic search-matching model with heterogeneous workers and aggregate productivity shocks. In [6] is found that workers respond to declining macroeconomic conditions by increasing work effort. In the paper [7] labour market institutions and policies are shown to affect the labour income share. In the article [8] author examines the effect of employment protection rules on labour productivity. The paper [9] analyses possible relations between Employment protection legislation, real GDP growth and wage share. The paper [10] studies the macroeconomic impact of a statutory minimum wage. The paper [11] investigates the relationship between political instability and labour market institutions. In the article [12] the effects of labour market reforms are studied in an innovation-driven model of endogenous growth with a heterogeneous labour force, labour market rigidities, and structural unemployment. In the article [13] is created structural vector autoregressive error correction model for labour productivity, employment, unemployment rate and real wages. The paper [14] uses individual-level data to estimate the labour market consequences of environmental policies. In the paper [15] a theoretical model to investigate the relation between corruption and labour supply is developed. The paper [16] proposes a novel approach to identify structural long-term driving forces of the labour market and their short-run state-dependent effects. The paper [17] has found a negative relation between long-run economic growth and unemployment. In the article [18] authors introduce wage inertia in the neoclassical one sector growth model. In the paper [19] is shown that a standard flexible price model with labour market frictions that allows hiring costs to depend on technology shocks may also lead to the same negative impact on labour inputs. The paper [20] examines the effect of minimum wage increases on hours of work and employment. The paper [21] analyses the evolution of the elasticity of labour demand and the possible role of offshoring therein. The paper [22] studies a labour market with search and matching frictions, and a monopoly union. The paper [23] explores uncertainty shocks as a driving force in a search and matching model of the labour market. The article [24] study a model where households are subject to uninsurable unemployment risk, price setting is subject to nominal rigidities, and the labour market is characterized by matching frictions and inflexible wages. Authors of the paper [25] develop a new Keynesian model with unemployment and endogenous participation. The article [26] proposes a model with an endogenous labour force and compare with the model with an exogenous labour force.

A well-developed market economy does not mean any kind of “absolute freedom” and “free play” of economic forces, directed by the “invisible hand” of self-regulated competition. For modern conditions, interweaving of market with state regulation methods and their combination in many spheres of economy is characteristic. So the labour market faces the opposite interests of employers and workers or firms and households. It is the state that can treat these antagonistic macroeconomic agents as a whole, as a single system of employers-workers and develop optimal solutions for their interaction, provide recommendations and regulate their activities. After all, it is the state that is interested in the fact that the individual results of the activities of firms and households accumulate in the maximum value of national income and employment.

Thus, the purpose of this article is to justify the necessity for state regulation of the labour market.

2 Results

The labour market, based on the results of the interaction of supply and demand, establishes the level of employment, which affects the supply of goods, the national income, and the effective households demand. In case of exceeding the supply of labour on demand, unemployment is created, which has not only economic but also social and political consequences. This shows the multifaceted nature of this problem. The state receives direct taxes on the income of households and firms in order to replenish the budget and perform its functions. This indicates the state's interest in ensuring that the profits of the employer-worker system (firms-households) are maximized but not fundamentally, exactly how these profits are distributed among the participants of the system, in case of equal rate of tax on the profits of employers or workers. At the same time, one of the functions of the state is the redistribution of income and the provision of social assistance to the unemployed. Thus, the state itself should aim to achieve optimal interaction between households and firms, minimum unemployment and maximum production. So, let's consider from the point of view of the state, the purpose of which is to obtain the maximum tax revenues to the budget from the total income of employers-workers, the functioning of this system.

For firms, the rest of the production factors, in addition to labour resources (fixed assets, circulating assets), do not have their economic interests, therefore, it can only be talked about their optimal use. Another parameter of optimization – the quantity of labour resources, has its own characteristics. On the one hand, the wages of workers are costs that increase the price of goods and services, and, on the other hand, wages are an incentive to work, that can motivate workers to increase their productivity, skills development and the use of talent, and thus to achieve greater profits by firms. In addition, it is human resources that are the driving force of progress, since no other production factor has such a unique characteristic as the mind and the ability to think and improve the environment. At the national economy's level, households' solvent demand affects the level of sales of goods of firms, and household saving is a source of realization of investment demand of firms.

Regarding the labour force, its owners should be considered as independent economic entities with their own interests. Therefore, it is necessary to define certain equilibrium conditions in the relations between employers (firms) and workers (households).

First, let's consider optimizing the profits of firms with the exception of wages (Fig. 1). The function $F(L)$ is increasing, but it is slower and concave (convex upward), because for the implementation of additional volumes of products and services in the market it is necessary to gradually reduce prices, attract more expensive resources, time, etc.

Then let's consider the workers (households) with the increasing convex down function of the expenses of $E(L)$ to provide the amount of labour in volume L , since, in addition to the restoration of physical and emotional forces, workers need to get education, train mental and professional abilities, improve their qualifications, etc.

By virtue of these significant nonlinearities, there are two points of break-evenness L_0 and L_n (points of intersection of the curves $F(L)$ and $E(L)$) in Fig. 1. Such situation

is in contrast to the standard linear case, where such a break-even point is one and the task is only to find it because the more L the better it seems to be.

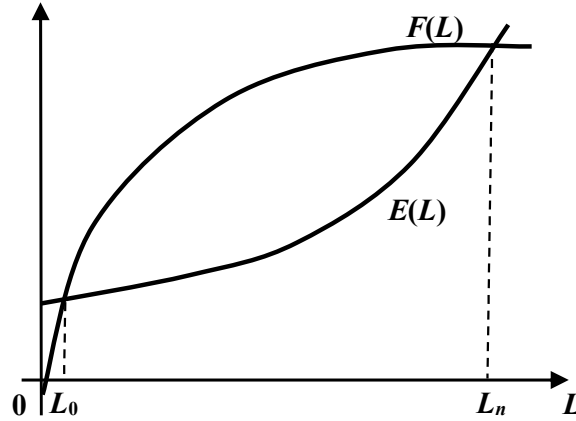

Fig. 1. Definition of break-even points of firms and households.

In fact, such an unlimited increase in profits is unrealistic, in addition to the left-hand side of the break-even, there will always be rights, and the truth, the maximum profit will be located somewhere in the middle. Therefore, it is inappropriate to restrict the analysis to the definition of the break-even point only; the optimum point should also be found.

From the standpoint of firms in general, should maximize total profits

$$P(L) = F(L) - E(L) \rightarrow \max_L \quad (1)$$

The maximum profit $P=AC$ (Fig. 2) of firms can be distributed among employers and workers as $P_1=AB$ and $P_2=BC$. The state also fulfills the goal and receives the maximum amount of tax revenues to the budget from the total income of employers and workers, namely, the rate as a percentage of $P_1=AB$ as taxes on employers and percent of $P_2=BC$ as taxes on workers.

Such a distribution of profit will correspond to the equilibrium of firms, when state regulation sets the wage rate for the production of a product unit W at the level $F'(L^*)=E'(L^*)$ and consider employers and workers as economically independent entities.

Then the functions $F(L)$ and $E(L)$ belong not to one, but to different economic entities. The interaction of the participants in the economic system of the household-firm is carried out through the wage rate W (which determines in Fig. 2 the angle of inclination of the tangent to the curves).

So, when $W^*=F'(L^*)=E'(L^*)$ firms solve their independent task:

$$F(M) - W^* \cdot M \rightarrow \max_{M \geq 0}, \quad (2)$$

and households solve their independent task:

$$W^* \cdot L - E(L) \rightarrow \max_{L \geq 0}, \quad (3)$$

and results coincide:

$$M^*(W^*) = L^*(W^*). \quad (4)$$

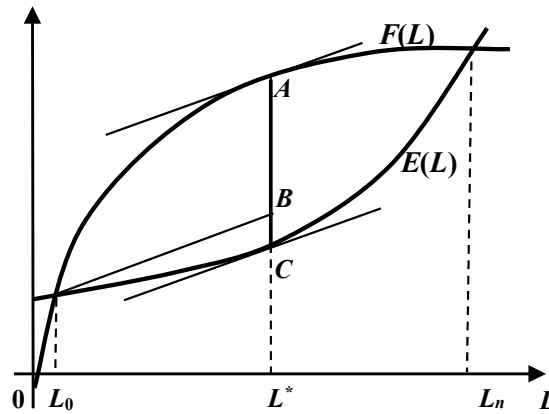

Fig. 2. Optimization of the wage rate from the point of view of the state and determination of the optimal amount of employment.

Namely, what amount of labour resources will be most advantageous for firms, it is this amount that is most advantageous to provide to households. Thus, in the state of equilibrium, the condition of optimality of the whole system is fulfilled.

It is clear that at any other wage rates $W \neq W^*$ the amount of attracted labour can only decrease in compare to the equilibrium (and optimally from the point of view of the system as a whole) $L^*(W^*) = M^*(W^*)$, since it is defined as $\min\{L^*(W^*), M^*(W^*)\}$ and a “bottleneck” will be created either because of a lack of demand at $L^*(W^*) > M^*(W^*)$ (when the wage rate is overvalued compared to W^*), or because of the lack of an offer for $L^*(W) < M^*(W^*)$ (at a wage rate lower than W^*).

Thus, in determining the level of remuneration by the methods of state regulation in the amount of W^* , not only maximization of tax revenues is achieved, but, at the same time, the condition for maximizing the profit of the whole system is fulfilled and the optimal level of employment is achieved.

The functioning of the modern labour market is characterized by the presence of trade unions, which affect the level of wages and working conditions of workers. The historical experience of the existence of trade unions proved their effectiveness and the necessity of existence as an organ representing the interests of workers. At the same time, there are negative consequences of trade unions, whose goal is to fight for the best conditions for those who work, but not for those who are unemployed. On the contrary, due to long-term labour contracts, high salaries, which are fought by trade unions, create so-called forced unemployment. That is, the task of the trade unions is to defend

the interests of not all households, but only of workers, they are not interested in employment, but wages.

Consider the case where the wage rate is not set by the state or firms, but by the trade unions, based on the interests of the cumulative worker:

$$P_2(L, W) = W \cdot L - E(L) \rightarrow \max_{L, W \geq 0}, \quad L \leq M^*(W). \quad (5)$$

The condition $L \leq M^*(W)$ makes the problem non-trivial; otherwise, it would be possible to infinitely increase the wage rate W , the amount of labour attraction and, accordingly, its share of profit $P_2(L, W)$. By virtue of this condition, the volume of labour should not exceed the amount of demand for it, which decreases with the increase of the wage rate, and for its expansion it is necessary to lower the rate (but then the attractiveness of labour will decrease). Thus, a joint optimization of the values of these parameters is required – wage rates and the amount of labour resources used.

According to Fig. 3, the profit of the workers is

$$P_2 = B_2 C_2 = B_2 G_2 - C_2 G_2 \quad (6)$$

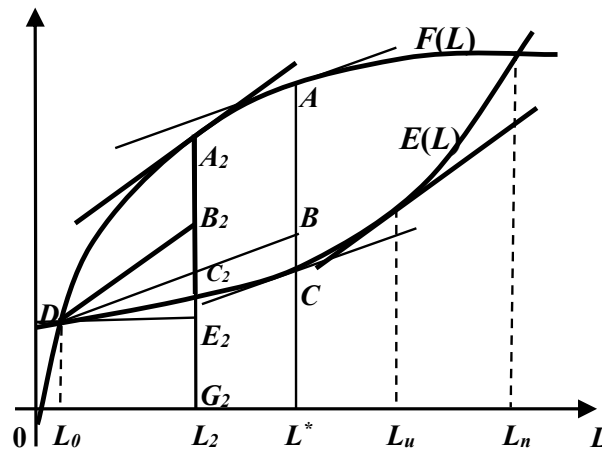

Fig. 3. Optimization of wage rates from the point of view of trade unions (aggregate worker).

Because $B_2 G_2 = B_2 E_2 + E_2 G_2$,

$$B_2 E_2 = DE_2 \cdot \operatorname{tg}(\angle B_2 DE_2) = (L_2 - L_0) \cdot F'(L_2), \quad (7)$$

$E_2 G_2 = E(L_0)$, $C_2 G_2 = E(L_2)$, then

$$P_2 = (L_2 - L_0) \cdot F'(L_2) + E(L_0) - E(L_2) \rightarrow \max_{L_2}. \quad (8)$$

Hence the necessary condition for extreme:

$$dP_2 / dL_2 = F'(L_2) + (L_2 - L_0) \cdot F''(L_2) - E'(L_2) = 0, \quad (9)$$

$$E'(L_2) = F'(L_2) + (L_2 - L_0) \cdot F''(L_2). \quad (10)$$

Since $L_2 - L_0 > 0$ and $F''(L_2) < 0$, $E'(L_2) < F'(L_2)$, that is $L_2 < L^*$, because $E'(L^*) = F'(L^*)$.

Second derivative

$$d^2 P_2 / (dL_2)^2 = 2F''(L_2) + (L_2 - L_0) \cdot F'''(L_2) - E''(L_2). \quad (11)$$

Here, $F''(L_2) < 0$, $-E''(L_2) < 0$, $F'''(L_2) < 0$, $-E'''(L_2) < 0$, $L_2 - L_0 > 0$, that is, if $F'''(L_2) < 0$, the second derivative is negative and with the employment L_2 and wage rate $W = F'(L_2)$ maximizes the income of workers. In comparison with the equilibrium W^* , the wage rate is optimal from the point of view of the worker, the corresponding increase (and theoretically the most favorable at this rate) is the increase in the amount of labour attraction Lu , but the use of labour resources L_2 , on the contrary, decreases even compared with L^* (not to mention Lu) because of the reduction in demand in the context of the increased use of labour by firms.

The total profit of the system thus decreases ($A_2C_2 < AC$), but the income of workers is increasing as much as possible ($B_2C_2 > BC$). Note that even when the establishment of the wage rate is the prerogative of trade unions (not the state and not employer-firms), this rate does not increase infinitely, but determined by its optimum value, taking into account labour demand.

However, when $F'''(L_2) > 0$ it is possible that the second derivative at point L_2 is positive, that is, the amount of the employment income of workers will reach not the maximum, but the minimum. This situation will be due to the high elasticity of the function $F(L)$, even if the insignificant growth of the wage bill significantly affects the employability of firms.

Thus, the overestimation of wage rates by trade unions leads to unemployment (in the amount of $L^* - L_2$, which can lead to an increase in the rate of natural unemployment), increase in prices and decrease in production and services, reduce of tax revenues (at a rate in percentage of the difference between the $AC - A_2C_2$) and the increase in budget expenditures for social assistance to the unemployed, which leads to a budget deficit.

Unprofitable and lowering of wage rates than W^* , as then the total profit of firms and the share of workers in its distribution will decrease.

Consider now the case where the wage rate is set not by the state and not by trade unions, but by employers-firms, based on the interests of their own profits:

(12)

$$P_1(M, W) = F(M) - W \cdot M \rightarrow \max_{M, W \geq 0}, \quad 0 \leq M \leq L^*(W). \quad (12)$$

Here the condition $M \leq L^*(W)$ makes the problem non-trivial; otherwise it would be possible to reduce the wage rate W to zero, unlimited increase in the demand for labour resources M and, accordingly, profit $P_1(M, W)$. By virtue of this condition, the

Here $F''(L_1) < 0$, $L_1 - L_0 > 0$, $E''(L_1) > 0$, and if $E'''(L_1) > 0$, then the second derivative is negative and at the level of employment L_1 and the wage rate $W = E'(L_1)$ the maximum profit of employers is reached.

Compared to the equilibrium W^* , the wage rate optimal from the point of view of firms decreases, desirable (theoretically the most favorable at this rate) demand for labour L_e increases, but the volume of supply L_1 decreases even compared with L^* (even say nothing of L_e) due to the reduction of the attractiveness of work among the workers.

At the same time, the aggregate profit of the system is decreasing ($A_1C_1 < AC$), tax revenues in the state budget are reduced, but employers' income grows as much as possible ($A_1B_1 < AB$). Note that even if the establishment of the wage rate is the prerogative of employers (not state and non-trade unions), this rate does not go down to zero, it determines its optimal value, taking into account the interests of workers. But nevertheless, for such a monopoly, the wage rate is reduced compared with the equilibrium (and optimally from the point of view of the system as a whole) value, and the level of employment falls (unemployment is the difference $L^* - L_1$).

However, when $E'''(L_1) < 0$ it is possible that the second derivative at point L_1 is positive, that is, for such a volume of production the profit of the employer will reach not the maximum, but the minimum. This situation will be due to the high elasticity of the function $E(L)$, even if a slight reduction in the wage rate significantly affects the amount of labour supply from the point of view of the workers.

So, under the condition of the positivity of the second derivative of the function $P_1(L)$ at the point L_1 , the equilibrium (W^* , L^*) is stable on the part of employers; from this state it becomes disadvantageous to reject even if it is possible to establish not only the volume of output itself but also the rate wages.

Thus, depending on the features of the functions $F(L)$ and $E(L)$, in particular their third derivatives, the equilibrium (and optimal) state of the system can be stable (by all participants), partially stable (by one of the participants) or unstable when each participant will play tug of war.

However, in the latest case it is possible to define a certain negotiation set $[E'(L_1); F'(L_2)]$, with only elements of which the wage rate may be established. Probably, in the interests of trade unions, to seek an increase of the wage rate, but to a certain limit – $F'(L_2)$. It is profitable for employers to reduce the wage rate, but not to zero, but to $E'(L_1)$. Of course, $W^* \in [E'(L_1); F'(L_2)]$, some deviations from W^* are possible under the pressure of one of the parties in accordance with the market conditions.

From the standpoint of the system as a whole, it is reasonable to balance the forces of the employers and the workers, which can be achieved through state regulation of wages. This is well illustrated by graphs that show the relationship between the volume of employment L and established different ways wage rate W (Fig. 5, 6).

The left and right sides (the halves before and after W^*) of these graphs can be arbitrarily combined, depending on the behavior of the third derivative of functions $E(L)$ (defines the left part of the graphs) and $F(L)$ (defines the right part).

The fig. 5, 6 show that only the optimal wage rate W^* (which could be set directly by the state) provides the maximum employment rate L^* . Under other conditions, when wages are not at the optimal level, unemployment will increase as $L^* > L_1 > L_2 > L_0$.

If the wages are set by firms, employment will reach L_1 , which is less than L^* (that is, the voluntary unemployment would increase), when overestimating the size of wages by trade unions, employment will decrease further more – to the value of L_2 (involuntary unemployment would increase), at the first point of the system breakeven employment L_0 will be the lowest.

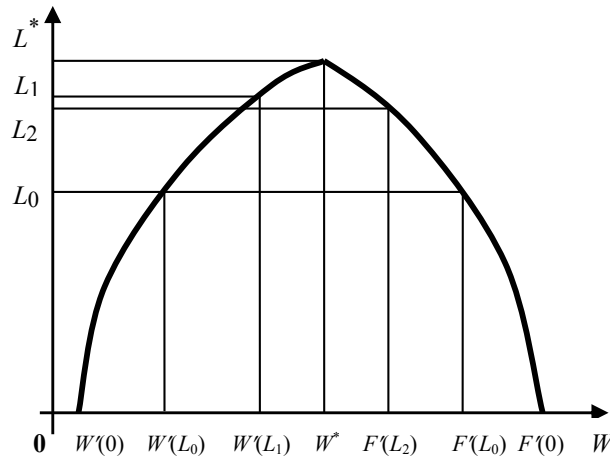

Fig. 5. Dependence of the employment rate on the wage rate at $W'''(L) > 0, F'''(L) < 0$.

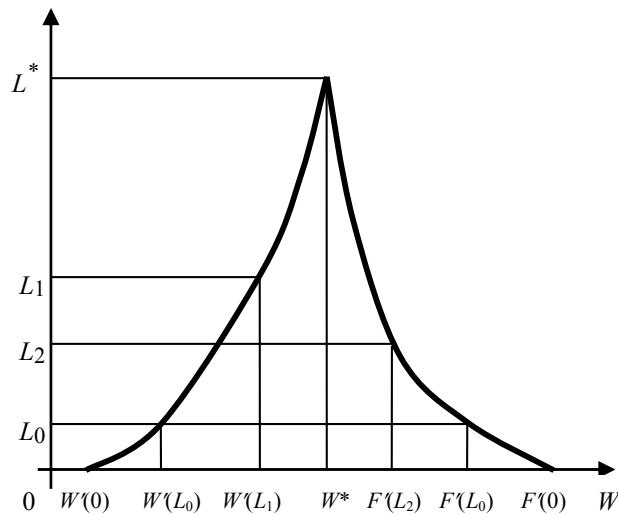

Fig. 6. Dependence of the employment rate on the wage rate at $W'''(L) < 0, F'''(L) > 0$.

Thus, the level of employment is adversely affected by both too low wages and too high. For the effective functioning of the firm-household system (which will be characterized not only by the highest employment but also by the maximum total net

income and, accordingly, the maximum tax revenues in the state budget) it is necessary to set the optimal salary W^* .

Inside the system it is fundamentally impossible to establish the optimal wage level W^* , in which unemployment will be the smallest. Such a level of remuneration can only be established by a non-systemic body, whose interest will be the effectiveness of the system as a whole. This is a general theoretical conclusion regarding any such systems with a dual (affiliate and antagonistic) character of the relations of the participants.

An important feature of our system of firm-household is the presence of the body (the state), which direct interest is precisely to maximize the financial result of the system (the tax base).

3 Conclusions

So it is the state, from the height of its point of view, have to direct the actions of the opposing economic forces into the best point of optimum. With the help of state regulation of wage rates, not only the maximum replenishment of budget taxes is achieved, but also the maximum employment. By the influence on the system of the firm-household, the state, having established wages at W^* level, achieves the best conditions for the development of the national economy, namely, the maximum profit of the aggregated system of the firm-household, and therefore the maximum national income, the maximum tax revenues to the budget and the maximum level of employment, and hence the high level of solvent demand of households, the maximum effect of the interaction of the participants of the system, and therefore the achievement of economic growth of the economy.

It has been established that the maximum tax base and the highest level of employment are achieved simultaneously, with the same optimal level of remuneration. The achievement of any of these two possible state objectives (the maximum tax base or the highest level of employment) is fundamentally impossible without the achievement of the other (even if you want to). None of these goals can be achieved separately from the other.

References

1. Brožová, D.: Modern Labour Economics: The Neoclassical Paradigm with Institutional Content. *Pr. Ec. & F.* **30**, 50–56 (2015)
2. Zanetti, F.: Labour market institutions and aggregate fluctuations in a search and matching model. *Journal of Macroeconomics.* **31**(5), 320–332 (2009)
3. Zanetti, F.: Labour market institutions and aggregate fluctuations in a search and matching model. *EER.* **55**(5), 644–658 (2011)
4. Străoanua, B.M., Pantazib, F.: Concepts and theories regarding economic balance in incidence with the labour market. *Pr.- S. & B. S.* **15**, 818–822 (2018)
5. Murtin, F., Robin, J.-M.: Labour market reforms and unemployment dynamics. *LE.* **50**, 3–19 (2018)
6. Senney, G.T., Dunn, L.F.: The role of work schedules and the macroeconomy on labour effort. *LE.* **57**, 23–34 (2019)

7. Parisi, M.L.: Labour market rigidity, social policies and the labour share: Empirical evidence before and after the big crisis. *Ec. Sys.* **41**(4), 492–512 (2017)
8. Bjugrenn, C.M.: Employment protection and labour productivity. *JPubE.* **157**, 138–157 (2018)
9. Brancaccio, E., Garbellini, N., Giametti, R.: Structural labour market reforms, GDP growth and the functional distribution of income. *Structural Change & Economic Dynamics.* **44**, 34–45 (2018)
10. Šauer, R.: The macroeconomics of the minimum wage. *Journal of Macroeconomics.* **56**, 89–112 (2018)
11. Lucifora, C., Moriconi, S.: Political instability and labour market institutions. *EJPE.* **39**, 201–221 (2015)
12. Agénor, P.-R., Lim, K.Y.: Unemployment, growth and welfare effects of labour market reforms. *Journal of Macroeconomics.* **58**, 19–38 (2018)
13. Lukianenko, I., Oliskevych, M.: The Effects of Shocks on the Ukrainian Labour Market: SVEC Modeling. *Pr. Ec. & F.* **27**, 311–322 (2015)
14. Yip, C.M.: On the labour market consequences of environmental taxes. *J Env Econ & Management.* **89**, 136–152 (2018)
15. Cooray, A., Dzhumashev, R.: The effect of corruption on labour market outcomes. *Ec. Mod.* **74**, 207–218 (2018)
16. Gehrke, B., Weber, E.: Identifying asymmetric effects of labour market reforms. *EER.* **110**, 18–40 (2018)
17. Chen, B.-L., Hsu, M., Lai, C.-F.: Relation between growth and unemployment in a model with labour-force participation and adverse labour institutions. *Journal of Macroeconomics.* **50**, 273–292 (2016)
18. Raurich, X., Sorolla, V.: Growth, unemployment and wage inertia. *Journal of Macroeconomics.* **40**, 42–59 (2014)
19. Mandelman, F., Zanetti, F.: Flexible prices, labour market frictions and the response of employment to technology shocks. *LE.* **26**, 94–102 (2014)
20. Zavodny, M.: The effect of the minimum wage on employment and hours. *LE.* **7**, 729–750 (2000)
21. Hijzen, A., Swaim, P.: Offshoring, labour market institutions and the elasticity of labour demand. *EER.* **54**, 1016–1034 (2010)
22. Krusell, P., Rudanko, L.: Unions in a frictional labour market. *JME.* **80**, 35–50 (2016)
23. Pries, M.J.: Uncertainty-driven labour market fluctuations. *JEDC.* **73**, 181–199 (2016)
24. Ravn, M.O., Sterk, V.: Job uncertainty and deep recessions. *JME.* **90**, 125 (2017)
25. Campolmi, A., Gnocchi, S.: Labour market participation, unemployment and monetary policy. *JME.* **79**, 17–29 (2016)
26. Chen, B.-L., Lai, C.-F.: Effects of labour taxes and unemployment compensation on labour supply in a search model with an endogenous labour force. *Journal of Macroeconomics.* **43**, 300–317 (2015)
27. Heyets, V., Voynarenko, M., Kholodenko, A., Stepanok, N.: Necessity of labour market state's regulation. *SHS Web of Conferences.* **65**, 04014 (2019). doi:10.1051/shsconf/20196504014

Forecasting Cryptocurrency Prices Time Series Using Machine Learning

Vasily Derbentsev^[0000-0002-8988-2526], Natalia Datsenko,
Olga Stepanenko^[0000-0003-2319-1383] and Vitaly Bezkorovainyi^[0000-0002-4998-8385]

Kyiv National Economic University named after Vadym Hetman, 54/1, Peremohy Ave., Kyiv,
03057, Ukraine

derbvd@gmail.com, d_tashakneu@ukr.net,
olga_stepanenko@kneu.edu.ua, retal.vs@gmail.com

Abstract. This paper describes the construction of the short-term forecasting model of cryptocurrencies' prices using machine learning approach. The modified model of Binary Auto Regressive Tree (BART) is adapted from the standard models of regression trees and the data of the time series. BART combines the classic algorithm classification and regression trees (C&RT) and autoregressive models ARIMA. Using the BART model, we made a short-term forecast (from 5 to 30 days) for the 3 most capitalized cryptocurrencies: Bitcoin, Ethereum and Ripple. We found that the proposed approach was more accurate than the ARIMA-ARFIMA models in forecasting cryptocurrencies time series both in the periods of slow rising (falling) and in the periods of transition dynamics (change of trend).

Keywords: cryptocurrency market, short-term forecasting model, machine learning approach.

1 Introduction

The rapid development of digital currencies during the last decade is one of the most controversial and ambiguous innovations in the modern global economy.

Significant fluctuations in the exchange rate of cryptocurrencies and their high volatility, as well as the lack of legal regulation of their transactions in most countries resulted in significant risks associated with investment into crypto assets. This has led to heated discussions about their place and role in the modern economy (see, for example [1-5]).

Therefore, the issue of developing appropriate methods and models for predicting prices for cryptographic products is relevant both for the scientific community and for financial analysts, investors and traders.

Methodological approaches to forecasting prices for financial assets depend on an analyst's understanding of the causal relationships in the pricing process.

For example, the forecasting model can be specified as a price formation model:

- Based on the interaction of market players (demand-supply models) that make economic decisions based on some indicators or regularities, taking into account objective economic laws or laws of behavioral finance (econometric and balance models);
- Given the past dynamics (time series models and autoregressive models),
- Taking into account production-technological possibilities of creating the corresponding asset (in particular, for commodity markets, fundamental valuation of shares, technological opportunities for mining cryptocurrency, etc.);
- Based on the consideration of random factors and events, for example, external shocks, which complicate the formal description of cause and effect relationships (stochastic models).

It should be noted that forecasting cryptocurrencies' prices is fundamentally different from forecasting other financial assets, in particular, ordinary (fiat) currencies, which have a large number of theoretical and empirical studies focused on studying their dynamics model.

There are two fundamentally different approaches to forecasting the exchange rate dynamics of currencies. The first approach is to build a cause and effect casual model that describes the relationship between exchange rates and other macroeconomic variables (in particular, the rates of economic growth, trade and balance of payments, purchasing power parity, public debt, inflation rates, etc.) within a certain theoretical economic concept.

The other approach is to study only the time series and make a prediction based on the processing and analysis of past observations. The most common models are the Box-Jenkins ARIMA time series models and their modifications, GARCH models, or artificial neural networks.

It should be noted that there is no consensus on the fundamental value of cryptocurrencies among scholars. The prevailing thesis is that the exchange rate of the majority of cryptocurrencies is determined only by the ratio of demand and supply [3, 4, 6-10].

Liu and Tsyvinski's [11] empirical analysis of the three most capitalized crypto currencies (Bitcoin, Ripple, and Ethereum) did not reveal a static relationship between the yield of cryptocurrencies and the complexity of their extraction.

At the same time, macroeconomic factors, which usually determine the dynamics of currency, stock and commodity markets have no significant effect on the dynamics of the cryptocurrencies market.

Conrad, et al. [12], also found that influence of the US stock market (SP500 index) and the global stock market index (Nikkei 225 index) on bitcoin's volatility was not significant.

In addition, the studies reported in [1, 8, 9] show that the price dynamics of cryptocurrencies is described by classical log-periodic models of price bubbles of Sornette [13] and their modifications.

A number of recent cryptocurrency market studies show that, unlike other financial assets, cryptocurrency prices are influenced by a number of specific factors that shape their demand, such as the number of Google trends searches, the number of posts in

social networks and other mass media [6, 14-16]. These studies substantiated the feasibility of using non-typical factors as predictors.

All of these factors complicate the development of casual econometric models of cryptocurrency price dynamics.

Recently, non-parametric methods based on Machine Learning and Deep Learning have gained popularity for the analysis and forecasting of financial and economic time series.

Models of Machine Learning are based on special artificial networks that allow to solve the problem of prediction and classification by utilizing learning sequences in the data. The effectiveness of such models depends on the training speed and the degree of universality of approximating functions.

These models combine an arsenal of powerful methods, such as Artificial Neural Network (ANN), Support Vector Machines (SVM), Decision and Classification Tree (DT, CT), Fuzzy Logic, Genetic Algorithms (GA), linear and nonlinear statistical models, etc.

Examples of their effective use in forecasting exchange rates and stock indices are given, in particular, by Peng et al. [17].

Several studies [18-20] reported the results of the Bitcoin exchange rate forecasting using classical ARIMA models and using different methods of machine learning, such as Random Forest (RF), Logistic Regression (LR) and Linear Discriminant Analysis (LDA), and Long Short-Term Memory (LSTM). The results from these analyses showed that the models that relied on training proved to be better suited for forecasting both the prices of cryptocurrencies and their volatility.

Rebane and Karlsson [21] conducted a comparative analysis of the ARIMA forecasting properties with recurrent neural networks (RNNs) for such cryptocurrencies as DASH, Ethereum (ETH), Litecoin (LTC), Siacoin (SC), Stellar (STR), NEM (XEM), Monero (XMR) and Ripple (XRP). The results showed that neural networks had better forecasting properties than ARIMA models.

Thus, in our view, the second approach, which is based on the application of the time series analysis using the CRISP-DM methodology [22], is more appropriate for predicting price trends in cryptocurrency.

The purpose of our work is to construct a short-term price forecasting model for the 3 cryptocurrencies with the highest market capitalization using binary autoregressive models and machine learning technology.

2 Methodology

2.1 CRISP-DM Approach

To solve the problem of forecasting the dynamics of cryptocurrencies, we used the CRISP-DM (Cross-industry standard process for data mining) methodology (Fig. 1-2).

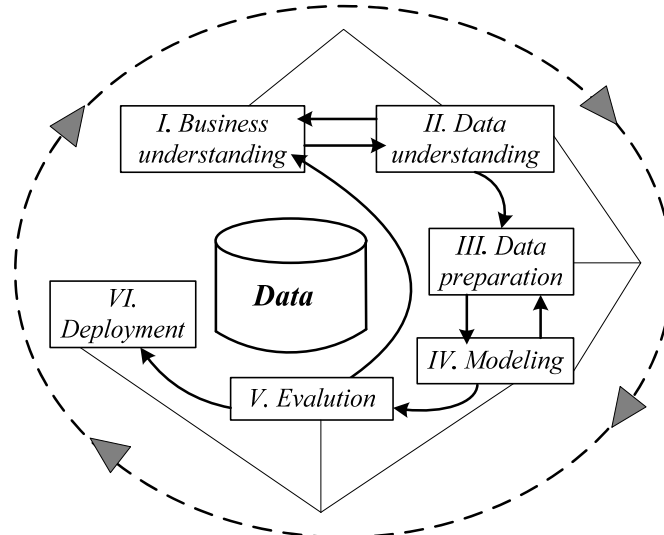

Fig. 1. The conceptual diagram of cryptocurrency forecasting based on the standard CRISP-DM.

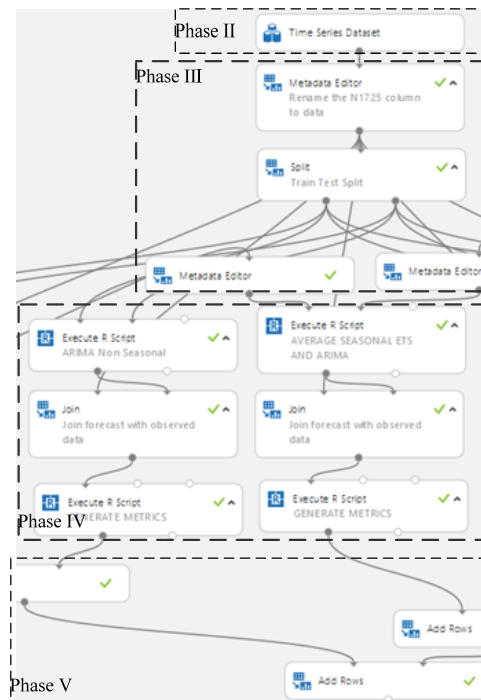

Fig. 2. An excerpt from the cryptocurrencies functional dynamics diagram in the Microsoft Azure Machine Learning Studio environment based on the CRISP-DM standard.

According to CRISP-DM, intelligent analysis is a continuous process with many cycles and feedback loops, and has six phases (I-VI).

The main advantage of the CRISP-DM is that it is platform- and application neutral and that it can be adapted to various applied problems.

Fig. 2 shows some of the CRISP-DM phases of the cryptocurrency forecasting functional dynamics diagram: Phase II: Data understanding, Phase III: Data preparation, Phase IV: Modeling, Phase V: Evaluation.

Methodology CRISP-DM is the most widespread publicly available standard process model that describes major phases and common data mining methods.

2.2 Regression Tree

The regression tree is a class of regression models that allows separating the input space of factor variables into segments. Subsequently, a separate piecewise regression model can be constructed for each of them representing a regression function in an intuitive and visual form [23-24].

In such a tree, internal nodes contain rules for splitting the space of explanatory variables; branches indicate the conditions and the transition between the nodes; and tree leaves are local regression models.

The essence of this method is in sequential division of the data set into non-intersecting classes, which, in turn, are also subject to a breakdown by a partition efficiency criterion.

The decision tree consists of the following elements: “nodes”, “leaves” and “branches”. “Branches” contain records of attributes which define the target function (result variable), the “leaves” are the values of the target function, and “nodes” are the remaining attributes under which the classification takes place.

There are two types of trees: (i) for classification, in this case, the result of the prediction is the data ownership class; and (ii) for regression, the result in this case is the predicted value of the target function.

2.3 BART Algorithm

Let us consider the proposed approach we call BART (Binary Auto Regressive Tree). It is a generalization of standard models of regression trees and is adapted to time series data. BART combines the classic classification and regression trees (C&RT) [24-25] algorithm and the standard autoregressive integrated moving average (ARIMA) models and their components (AR, MA). Models of ART (Auto Regressive Tree) are closely related to the models of the TAR (threshold autoregressive model) threshold autoregression models of the class and their modifications SETAR and ASTAR [24]. The SETAR and ASTAR models are linear models that construct multiple adaptive regression splines (MARS) based on time series [26-27]. BART models differ from the SETAR and ASTAR models in two ways:

- (1) Error estimates for models based on BART differ from one another;
- (2) BART models allow for the gap between built-in auto regression models.

To convert a time series, the “window” data conversion method is used. The result variable Y_t in this algorithm corresponds to the previous value (Y_{t-1}) and the value with the lag p (Y_{t-p}). This separation of the input space into segments (Fig. 3) allows to construct a separate (local) model for each of them and to represent a piecewise function as an autoregressive tree (Fig. 4) in an intuitive visual form.

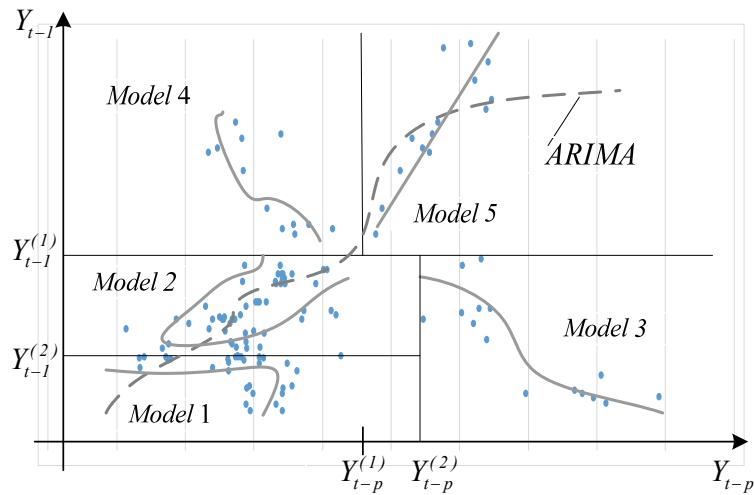

Fig. 3. Separation of the input space into segments.

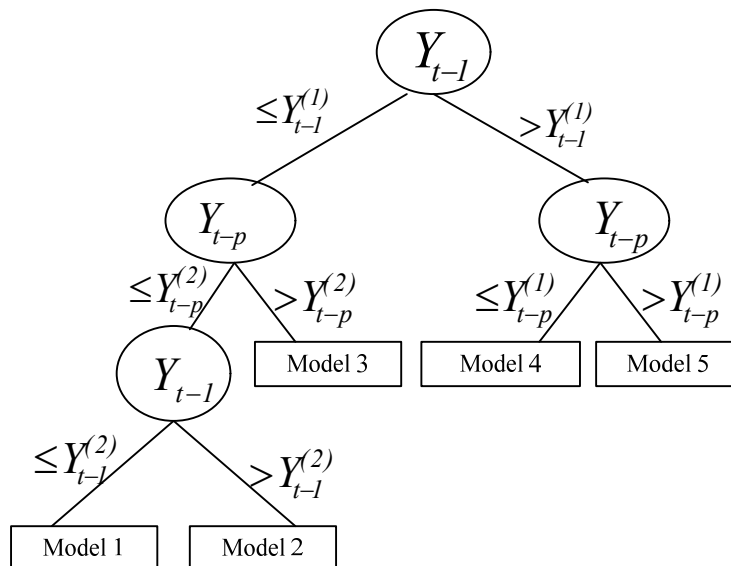

Fig. 4. Autoregressive tree building diagram.

Most such algorithms apply a recursive separation of training data. In BART, unlike other algorithms, a *step-by-step (staged and iterative) method of constructing a tree is used*:

Step 1. The construction of a regression tree begins from a single value (root node), which is defined as the Median (Me , second quartile $Q_{50\%}$) of the entire time series Y_t and is calculated the equation

$$ME=Q_{50\%}=0.5(Y_i^{min}+Y_i^{max}) \quad (1)$$

The median of the time series is defined as the median of the distribution of realization of a random variable at time t , that is, a real number with probability of exceeding an arbitrary dimension equal to 0.5. For a stationary series and a series with a symmetric distribution, this value does not depend on the time of observation $Me = \bar{Y}_t$ and coincides with the mean value of the series. Sometimes in the literature, the median is considered to be a prototype of a simple stable output.

Step 2. The best split is found for each unprocessed node, and it is selected according to a predefined rule.

These procedures are performed similarly to the C&RT algorithm. The difference lies in the accepted rules, criteria for evaluation and termination of splitting. We have used an alternative selection criterion (or informational criterion) for better splitting based on the entropy indicator, because it gives preference to options with less tree complexity. This algorithm will determine an entropy information gain.

In constructing BART, the number of branches (branching) is 2, that is, each node has two child nodes. The final tree is chosen from these nodes, and we have to evaluate informativeness of not only the predictor nodes that divide the time series into subsets, but also of those that separate a certain group of subsets from the set, that is, the subtree from the rest of the tree.

Entropy criterion. Initially, the probability is estimated as the frequency of assigning a particular observation to a certain subset (subtree) and the entropy \hat{H} sampling Y^t is calculated using the following equation:

$$\hat{H}(P, N) = H\left(\frac{P}{P+N} + \frac{N}{P+N}\right). \quad (2)$$

After all the information in the node is obtained for a certain predecessor, entropy is calculated using the following equation:

$$\hat{H}_\phi(P, N, p, n) = \frac{p+n}{P+N} \hat{H}(p, n) + \frac{P+N-(p+n)}{P+N} \hat{H}(P-p, N-n), \quad (3)$$

where $P -$ is the number of objects that correspond to a subset C , and $p -$ is the number of objects that correspond to the membership conditions of a subset, $p \in P$, similarly n and N are such that $n \in N$, $N \in C$.

Then the entropy of the sample $\{x \in Y^l | \phi(x)=1\}$ will be $\hat{H}(p, n)$, and the probability of obtaining an element from this sample will be calculated as $\frac{p+n}{P+N}$. Similarly, for the sample $\{x \in Y^l | \phi(x)=0\}$ entropy $\hat{H}(P-p, N-n)$ can be calculated with probability $\frac{(P-p)+(N-n)}{P+N}$. Thus, the entropy of the whole sample after obtaining information ϕ is calculated using equation (3).

Then the decrease of entropy can be calculated as:

$$\text{IGain}_c(\phi, Y^l) = \hat{H}(P, N) - \hat{H}(P, N, p, n) \quad (4)$$

which is called *entropy information gain*, which is the amount of information about the current division of the tree into two classes «*c*» and «*not c*».

In addition, in the BART algorithm for the early termination criterion Q , we used an extended Bayesian information criterion [28], which minimizes the statistic:

$$\text{EBIC} = n \cdot \ln \frac{\text{SSE}}{n} + J \cdot [\ln(n) + 2 \ln(p)], \quad (5)$$

where SSE – is the sum of squares of the residuals of the model; J – is the number of model parameters; n – is the number of examples of training sample; p – is the quantity that characterizes the complexity of the model space (it is the product of the tree size and the number of explanatory variables).

In equation (5), the first term is the maximum value of the plausibility logarithmic function, and the second is a penalty for the model complexity.

Splitting of the nodes continues until the EBIC value is reduced. Note that the application of this criterion in the recursive approach of the algorithm of the regression tree is not possible. This is due to the fact that in the recursive method during tree construction only part of the model is considered at a time without considering the complete model as a whole.

For BART, the simplification procedure (i.e., early termination of the tree branching) is more important than, for example, for classification trees. This is due to the fact that regression trees tend to be more complex, because the variety of the investigated metric values (for example, the price of regression) is much more diverse than for qualitative data.

Step 3. If the selected split improves the model and it is valid with an entropy information gain, then this split is performed and step 2 is repeated. Otherwise, the final tree is selected and the BART algorithm execution procedure is considered complete.

The rejection of recursion in the BART algorithm and the transition to the iterative version allows for a complete control of the tree construction process, that is, it provides a “softer” control of the tree construction process at the expense of the following:

- (1) Determining the arbitrary order of split nodes;

- (2) Introducing early termination rules / algorithms that analyze both separate nodes and the whole regression tree as a whole;
- (3) Termination of the construction of the regression tree at any time.

Because the ultimate goal of the proposed algorithm is forecasting, the standard regression model of the ARIMA class, which is a traditional tool for forecasting financial series, needs to be built on the nodes-leaves:

$$\Phi(L)(1-L)^d X_t = \mu + \Theta(L)\varepsilon_t, \quad \varepsilon_t \sim N(0, \sigma^2) \quad (6)$$

where Y_t – is the time series, L – is the lag operator, $\Phi(L)$ – is the polynomial degree p from L , μ – is the average process value, $\Theta(L)$ – is the polynomial degree q from L , ε_t – is white noise, d – is the order of process integration Y_t . If $d=0$, then process X_t can be described by ARMA (p, q) or ARIMA ($p, 0, q$).

This process is stationary and has a short memory. If $d=1$, then the series has infinite memory, that is, each perturbation has an impact on the behavior of the process indefinitely.

Thus the result variable Y_t in this algorithm corresponds to the previous value (Y_{t-1}) and the lag p (Y_{t-p}). Also, the separation of the input space into segments allows to construct an own (local) model for each of them and to represent a piecewise function as an autoregressive tree in an intuitive visual form.

3 Empirical Results

For performing empirical analysis, we selected three cryptocurrencies which are the market capitalization leaders: Bitcoin (BTC), Ethereum (ETH) and Ripple (XRP). We have taken daily closing prices for the period from 01/01/2017 to 01/03/2019, according to Yahoo Finance [29] and calculated their time series in log-return.

To compare the predictive properties of the BART algorithm, we also made a forecast using the classical ARIMA (1, 0, 1) and ARFIMA (1, d , 1) models.

As a parameter d in ARFIMA we can use appropriate Hurst exponents (see, for example E. Peters [30]). So we selected as the difference parameter d for ARFIMA models for each currency such values [31]:

$$H(BTC) = 0.75, \quad H(ETH) = 0.83, \quad H(XRP) = 0.66.$$

The sample size for training for all sub-periods for the BART algorithm was 80% of the total sample size, and 20% was used as out-of-sample dataset.

To implement the models, we chose the Microsoft Azure Machine Learning Studio Cloud Application. A fragment of the implementation of machine experiments is shown in Fig. 5.

For each model the target variable is the log-return for the next time period. The forecast was carried out on five different time horizons: 5, 10, 14, 21, and 30 days using three models for each cryptocurrency.

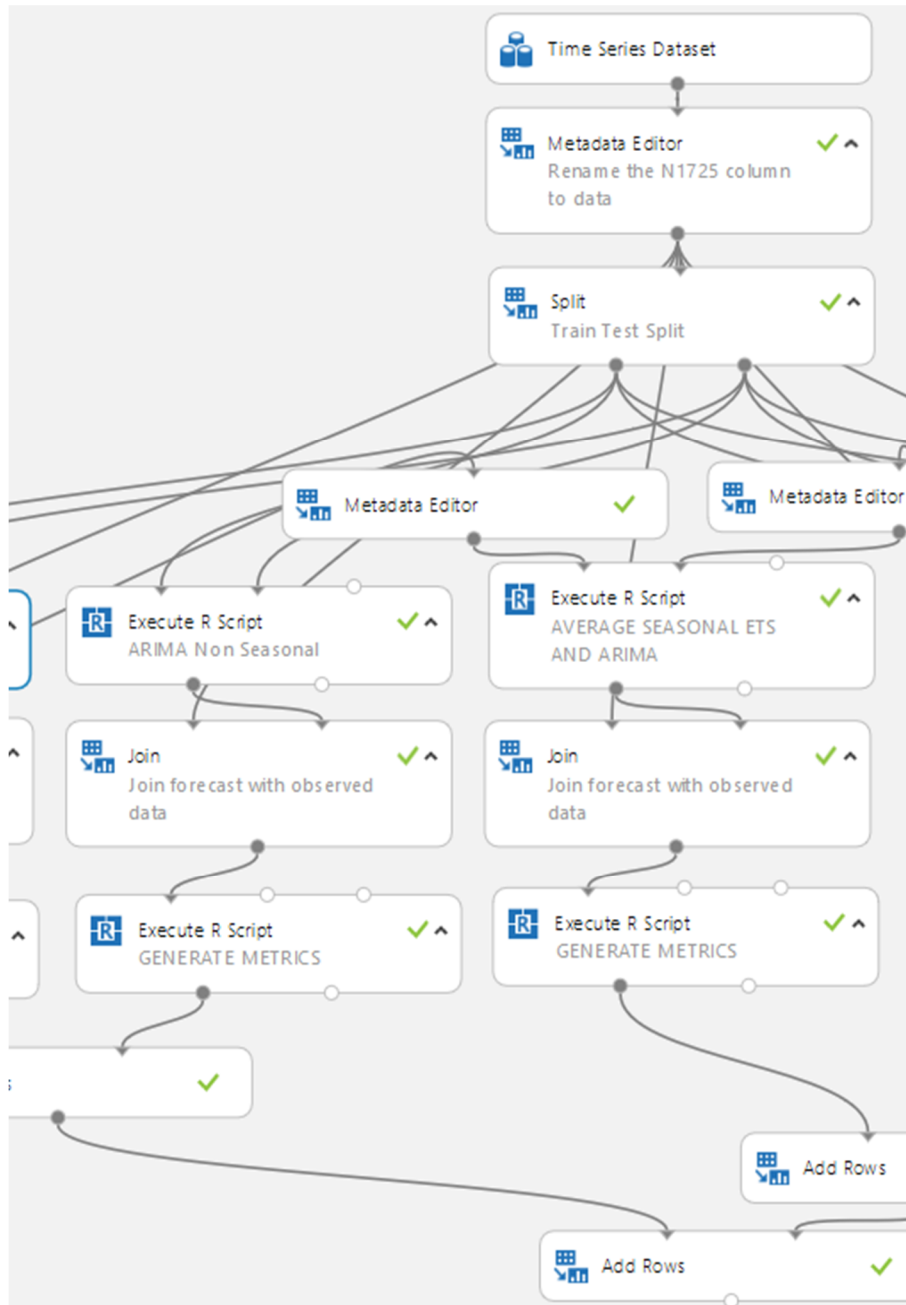
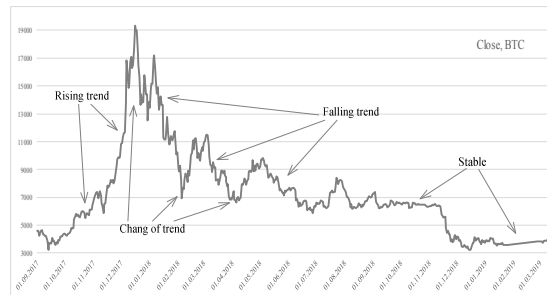

Fig. 5. A diagram of the forecasting cryptocurrencies times series experiments in MS Azure Machine Learning environment.

To check the effectiveness of the BART algorithm and that of the classical models, we conducted tests for periods with different types of dynamics of cryptocurrencies time series (two subperiods for each type), namely (Fig. 6):

- (1) Stable period;
- (2) Falling trend;
- (3) Transition dynamics (change of trend);
- (4) Rising trend.



(a)

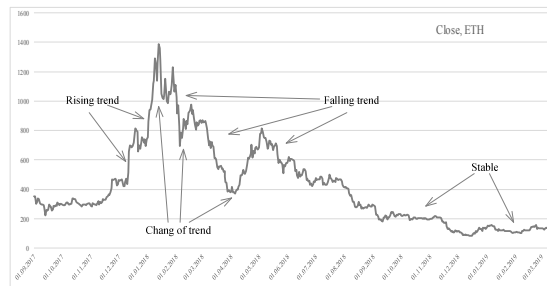

(b)

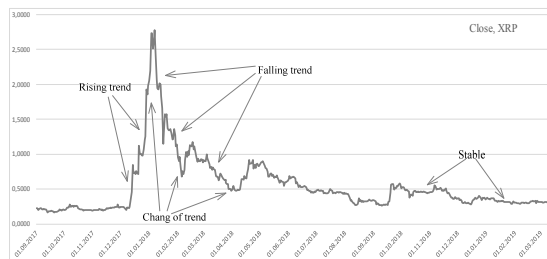

(c)

Fig. 6. Selected periods with different types of dynamics of cryptocurrencies time series: (a) BTC, (b) ETH, (c) XRP.

As we can see, BTC is a driver and other cryptocurrencies repeat its dynamics.

Fig. 7-8 illustrate the forecast accuracy for 3 models for ETH in the period of slow rising (falling) (Fig. 7) and rapid trend change period (Fig. 8). Forecasting accuracy for BTC and XRP have the same properties as ETH.

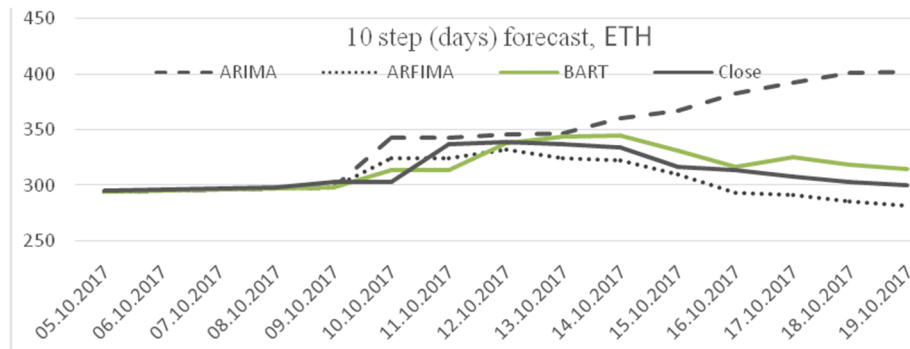

Fig. 7. 10-step (days) forecast performance for ETH in the period of slow rising (falling).

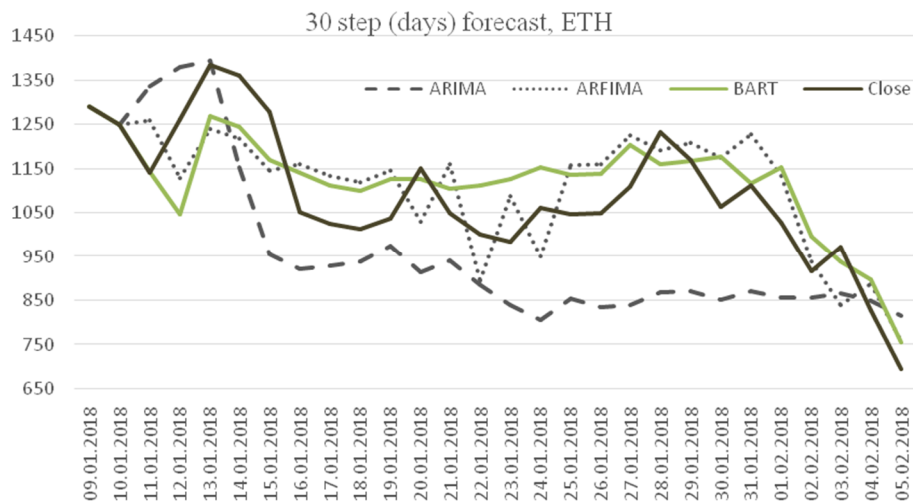

Fig. 8. 30-step (days) forecast performance for ETH in transition dynamics period.

To estimate the prognostic properties of the models we used the Root Mean Square Error metric (RMSE).

Results (averaged over three cryptocurrencies) of forecasting performance for all sub-periods are shown in Table 1.

The obtained results indicate that for the investigated time series of cryptocurrencies, the proposed approach gives RMSE over the range 4% for the 14 days forecast horizon without reference to the type of dynamic behavior, over the range 6% for the 21 days and 8% for the 30 days forecast horizon, respectively.

Table 1. Summary (average in three cryptocurrencies) of the forecast accuracy RMSE, %

Model	Step forecast, days				
	5	10	14	21	30
Stable period *					
ARIMA	4.27	6.54	6.80	12.20	15.08
ARFIMA	3.93	4.87	5.30	6.00	8.60
BART	2.76	3.11	3.45	3.73	4.83
Falling trend **					
ARIMA	7.13	10.12	11.10	12.47	16.40
ARFIMA	4.98	5.34	7.70	8.73	9.26
BART	2.97	3.64	3.30	4.15	5.60
Transition dynamics (change of trend) ***					
ARIMA	6.76	7.03	7.30	13.61	18.51
ARFIMA	3.34	3.67	4.00	6.44	8.76
BART	2.82	3.16	3.50	5.59	7.61
Rising trend ****					
ARIMA	6.82	11.99	13.15	14.07	15.34
ARFIMA	4.63	4.42	7.20	7.81	8.93
BART	2.25	2.98	3.70	3.34	5.64

* sub-periods: 11/09/2018-09/11/2018, 27/12/2018-25/02/2019

** sub-periods: 06/01/2018-09/02/2018, 12/03/2018-10/04/2018

*** sub-periods: 04/12/2017-02/01/2018, 22/04/2018-21/05/2018, 02/03/2018-04/05/2018

**** sub-periods: 09/10/2017-19/12/2017, 10/02/2018-11/03/2018

The results show that for selected time series for the short-term forecast, the error of BART algorithm is half the size of the error of ARIMA model, on average, and it is 15-20% lower than the error of ARFIMA model for slowly changing periods (both falling and rising).

Note that all of our models show worse forecast accuracy for the periods of complex dynamic modes (rapid trend change periods).

In addition, the proposed algorithm is more accurate in the periods of transition dynamics (change of trend) compared to ARIMA-ARFIMA models.

4 Concluding Remarks

The modified model of Binary Auto Regressive Tree (BART) is adapted from the standard models of regression trees to the data of time series. BART combines the classic algorithm C&RT and autoregressive models ARIMA.

One of the advantages of the proposed method is the use of the “window” data transformation method for the time series.

The obtained results proved that the BART algorithm is more accurate for all investigated time series of cryptocurrencies and subperiods. In particular, RMSE for this algorithm for the horizon of 14, 21, and 30 days was within the range of 4%, 6%, and 8%, respectively.

The proposed BART method for analyzing and forecasting cryptocurrencies time series demonstrated higher efficiency for building forecast estimates in comparison

with traditional time series technique, regardless of whether the target data is collected before, during or after a recession.

References

1. Baek, C., Elbeck, M.: Bitcoins as an investment or speculative vehicle? A first look. *Appl. Econ. Lett.* **22**(1), 30–34 (2015)
2. Bariviera, A., Basgall, M., Hasperue, W., Naiouf, M.: Some stylized facts of the Bitcoin market. *Physica A.* **484**(3), 82–90 (2017)
3. CNBC: Top Economists Stiglitz, Roubini and Rogoff Renew Bitcoin Doom Scenarios. <https://www.cnbc.com/2018/07/09/nobel-prize-winning-economist-joseph-stiglitz-criticizes-bitcoin.html> (2018). Accessed 15 Feb 2019
4. Selmi, R., Tiwari, A., Hammoudeh, S.: Efficiency or speculation? A dynamic analysis of the Bitcoin market. *Econ. Bull.* **38**(4), 2037–2046 (2018)
5. Stepanenko, O.: Problems and Prospects of Financial Provision Modeling of Ecological, Economics and Production Systems in the Digital Economy. In: Proceedings of the 7th International youth conference on Perspectives of science and education, pp. 421–430 (2019)
6. Bouoiyour, J., Selmi, R.: What does Bitcoin look like? *Ann. Econ. Financ.* **16**(2), 449–492 (2015)
7. Cheah, E., Fry, J.: Speculative bubbles in Bitcoin markets? An empirical investigation into the fundamental value of bitcoin. *Econ. Lett.* **130**, 32–36 (2015)
8. Ciaian, P., Rajcaniova, M., Kancs, D.: The economics of BitCoin price formation. *Appl. Econ.* **48**(19), 1799–1815 (2016)
9. Blau, B.: Price dynamics and speculative trading in bitcoin. *Res. Int. Bus. Financ.* **43**, 15–21 (2018)
10. Balcilar, M., Bouri, E., Gupta, R., Roubaud, D.: Can volume predict bitcoin returns and volatility? A quantiles-based approach. *Econ. Model.* **64**, 74–81 (2017)
11. Liu, Y., Tsyvinski, A.: Risks and Returns of Cryptocurrency. Technical report. National Bureau of Economic Research <https://www.nber.org/papers/w24877> (2018). Accessed 15 Feb 2019
12. Conrad, C., Custovic, A., Ghysels, E.: Long- and Short-Term Cryptocurrency Volatility Components: A GARCH-MIDAS Analysis. *J. Risk Financ. Manag.* **11**(2), 23 (2018). doi:10.3390/jrfm11020023
13. Sornette, D.: *Critical Phenomena in Natural Sciences, Chaos, Fractals, Self-organization and Disorder: Concepts and Tools*. Springer, Heidelberg (2004)
14. Jain, R., Nguyen, R., Tang, L., Miller, T.: Bitcoin Price Forecasting using Web Search and Social Media Data. Oklahoma State University. Paper 3601-2018. <https://www.sas.com/content/dam/SAS/support/en/sas-global-forum-proceedings/2018/3601-2018.pdf> (2018). Accessed 15 Feb 2019
15. Kim, Y., Kim, J., Kim, W., Im, J.: Predicting Fluctuations in Cryptocurrency Transactions Based on User Comments and Replies. *PLoS ONE.* **17**, 1–17 (2016). doi: 10.1371/journal.pone.0161197
16. Galeshchuk, S., Vasylyshyn, O., Krysovaty, A.: Bitcoin Response to Twitter Sentiments. *CEUR Workshop Proceedings.* **2104**, 160–168. http://www.ceur-ws.org/Vol-2104/paper_199.pdf (2017). Accessed 15 Feb 2019

17. Peng, Y., Albuquerque, P.H.M., de Sá, J.M.C., Padula, A.J.A., Montenegro, M.R.: The best of two worlds: Forecasting high frequency volatility for cryptocurrencies and traditional currencies with Support Vector Regression. *Expert Syst. Appl.* **97**, 177–192 (2018)
18. Amjad, M., Shah, D.: Trading Bitcoin and Online Time Series Prediction. In: NIPS 2016 Time Series Workshop. <http://proceedings.mlr.press/v55/amjad16.pdf> (2016). Accessed 15 Feb 2019
19. Saxena, A., Sukumar, T.: Predicting bitcoin price using LSTM and compare its predictability with ARIMA model. *Int. J. Pure Appl. Math.* **119**(17), 2591–2600 (2018)
20. McNally, S.: Predicting the price of Bitcoin using Machine Learning. Doctoral dissertation, National College of Ireland (2016)
21. Rebane, J., Karlsson, I.: Seq2Seq RNNs and ARIMA models for Cryptocurrency Prediction: A Comparative Study. In: SIGKDD Fintech'18, August 2018, London, UK. https://fintech.kdd2018.a.intuit.com/papers/DSF2018_paper_papapetrou.pdf (2018). Accessed 15 Feb 2019
22. Kurgan, L., Musilek, P.: A survey of Knowledge Discovery and Data Mining process models. *Knowl. Eng. Rev.* **21**(1), 1–24 (2006)
23. Breiman, L., Friedman, J., Stone, C., Olshen, R.: *Classification and Regression Trees*. Chapman and Hall/CRC, Boca Ration (1984)
24. Breiman, L.: Random forests. *Mach. Learn.* **45**(1), 5–32 (2001)
25. Tong, H.: *Threshold models in Nonlinear Time Series Analysis*. Springer-Verlag, NewYork (1983)
26. Friedman, J.H.: Greedy function approximation: A gradient boosting machine. *Ann. Stat.* **29**, 1189–1232 (2001)
27. Chipman, H., George, E., McCulloch, R.: Bayesian CART model search. *J. Am. Stat. Assoc.* **93**, 935–948 (1998)
28. Chen, J., Chen, Z.: Extended Bayesian information criteria for model selection with large model spaces. *Biometrika.* **95**(3), 759–771 (2008)
29. Yahoo Finance. <https://finance.yahoo.com> (2019). Accessed 2 Mar 2019
30. Peters, E.E.: *Fractal Market Analysis: Applying Chaos Theory to Investment and Economics*. John Wiley and Sons, Hoboken (1994)
31. Derbentsev, V., Kibalnyk, L., Radzihovska, Yu.: Modeling Multifractal Properties of Cryptocurrency Market using Hurst Exponent and Detrended Fluctuation Analysis. *J. Environ. Econ. Manag. Special Issue* (2019, in press)
32. Derbentsev, V., Datsenko, N., Stepanenko, O., Bezkorovainyi, V.: Forecasting cryptocurrency prices time series using machine learning approach. *SHS Web of Conferences.* **65**, 02001 (2019). doi:10.1051/shsconf/20196502001

Modeling the Stability of the Country's Financial System

Valdemar Vitlinskyi

Kyiv National Economic University named after Vadym Hetman, 54/1, Peremohy Ave., Kyiv,
03057, Ukraine
wite101@meta.ua

Liubov Makhanets

Yuriy Fedkovych Chernivtsi National University, 2, Kotsyubynskoho Str., Chernivtsi, 58012,
Ukraine
l.makhanets@chnu.edu.ua

Abstract. The security of the public finance sector of Ukraine requires monitoring of indicators of the stability of the financial system of the country, as well as modeling the impact of these indicators on the country's financial security. It is shown that the stability of the financial system of the economy can be checked with the help of the provisions of econophysics. The concept of equilibrium is using to determine stability. The influence of factors on the level of financial security, which is one of the aspects of assessing the stability of the financial system of Ukraine is able to evaluate by simulation. The model of the financial system stability of the country is constructed in the paper. This research can serve as the basis for the adoption by the relevant state institutions of sound decisions on ensuring the stability of the financial system of Ukraine.

Keywords: stability of the financial system, stability coefficient, econophysics, index financial stability.

1 Introduction

At the present stage the main threat to the security of the public finance sector of Ukraine is the deepening of the economic crisis. The deterioration in the financial position of enterprises and banks increases the risks of a lack of government revenue and leads to an increase in the state budget deficit and in public debt. All this requires monitoring of indicators of the stability of the financial system of the country, as well as modeling the impact of these indicators on the country's financial security.

The list of indicators to be monitored should include those indicators that have the most significant impact on the sovereign credit rating of the country [1], taking into account the constraints defined, in particular, by single-factor models [2], as well as the indicators recommended by the Ministry of Economic Development and Trade of Ukraine for the assessment of the budget security [3].

The negative impact of military actions on the country's economy in 2014 has weakened the sustainability of public finances in Ukraine. The probability of default

has increased, which is reflected in the corresponding reaction of the financial markets and the growth of the spread between the level of yield of debt obligations of Ukraine and the US from 5.9 in. in 2010 to 9.3 in. in 2014 [4]. Exceeding all parameters of the debt dependence of safe levels starting from 2014 in conjunction with the increase of currency risks, deteriorating financial situation of the real and banking sectors in the context of military operations in the East of the country creates a critically high threat to the stability of the financial system of Ukraine.

2 Data and Methods

Since, according to the above-mentioned method the greatest impact on the stability of the country's financial system have the GDP and gross external debt, let us analyze them for the presence of a trend, that is, a steady trend.

More reliable estimates of the sustainable development of the financial system are the analysis of fractal time series of the dominant parameters of the functioning of the system and the creation of a model for its fractal development [5].

The method of normalized scope and the estimation of the Hurst index is an effective method of studying fractal characteristics of time series in forecasting the dynamics of economic indicators of the enterprise. The main difference between the normalized scale method or the *R/S* prediction method from other statistical methods is that this method includes in its analysis the direction of time, while other methods are invariant with respect to time.

The application of the method involves the following steps, which are described in [6].

By the value of the Hurst index, it can be concluded:

1. If $H = 0.5$, the economic process is a random walk, and the scale of accumulated deviations should increase proportionally to the square root of the time.
2. $0 < H \leq 0.5$. This range corresponds to the ergodic anti-persistent series. This type of process is often referred to as "return to the average".

The anti-persistent time series is more variable than a series of random ones, since it consists of frequent "rebound" reverses. If the process demonstrates an increase in the previous period, then the next period is most likely to begin to decline. Conversely, if there was a downturn, then the upsurge is likely to happen. The stability of this behavior depends on how close H is to zero. The closer its value to zero, the greater the value of the coefficient of negative auto-correlation of the time series levels is.

3. If $0.5 < H \leq 1.0$ then it is persistent, or trend-stable rows. If the series increases (decreases) in the previous period, then it is likely to keep this trend for some time in the future (trends are obvious). Trend-stability of behavior, or strength of persistence, increases with the degree of approximation of H to unit, or 100% of autocorrelation. The closer H is to 0.5, the more a series is exposed to noise and the less pronounced its trend.

Persistent series is a generalized Brownian motion, or accidental wandering with drift. The shear force depends on how much H exceeds 0.5. Such ranks are unstable, they are characteristic of the capital markets. The persistent time series has a long-lasting memory, so there are long-term correlations between current events and future events.

The fact that H differs from 0.5 means that observations are not independent. Each observation carries the memory of all past events. This is not a short-lived memory, often referred to as “Markov”. This is another memory – a long-term, in theory it is stored for a sufficiently long period. That is, recent events have a more powerful effect than events are remote, but the residual effects of the latter are always tangible.

3 Results

Data for carrying out R/S are presented in Table 1.

Table 1. Estimated data for the analysis of the sustainability of GDP and gross external debt (GD_{ex}).

No.	$\ln(R/S)$ GDP	$\ln(n)$ GDP	$\ln(R/S)$ GD_{ex}	$\ln(n)$ GD_{ex}
1	1.10068659	3.17805383	1.04352951	3.17805383
2	1.08150729	3.13549422	1.02549389	3.13549422
3	1.06451688	3.09104245	1.01737242	3.09104245
4	1.05453218	3.04452244	1.00313217	3.04452244
5	1.04858468	2.99573227	1.00131357	2.99573227
6	1.04763452	2.94443898	0.998764675	2.94443898
7	1.04369136	2.89037176	0.996824462	2.89037176
8	1.05215859	2.83321334	1.00690501	2.83321334
9	1.08426639	2.77258872	1.02762892	2.77258872
10	1.08895394	2.7080502	1.00029172	2.7080502
11	1.11848259	2.63905733	1.02620852	2.63905733
12	1.14601263	2.56494936	1.06203919	2.56494936
13	1.14076836	2.48490665	1.09404997	2.48490665
14	1.06445657	2.39789527	1.18892034	2.39789527
15	1.1027381	2.30258509	1.23596231	2.30258509
16	1.12551333	2.19722458	1.22235815	2.19722458
17	1.06595083	2.07944154	1.17397935	2.07944154
18	1.08108497	1.94591015	1.24219891	1.94591015
19	1.05547763	1.79175947	1.06003317	1.79175947
20	0.969570178	1.60943791	1.04344059	1.60943791

Source: Calculated by the authors on the basis of statistical data [7–9]

In Fig. 1 and 2 are the normalized magnitudes for the analyzed parameters.

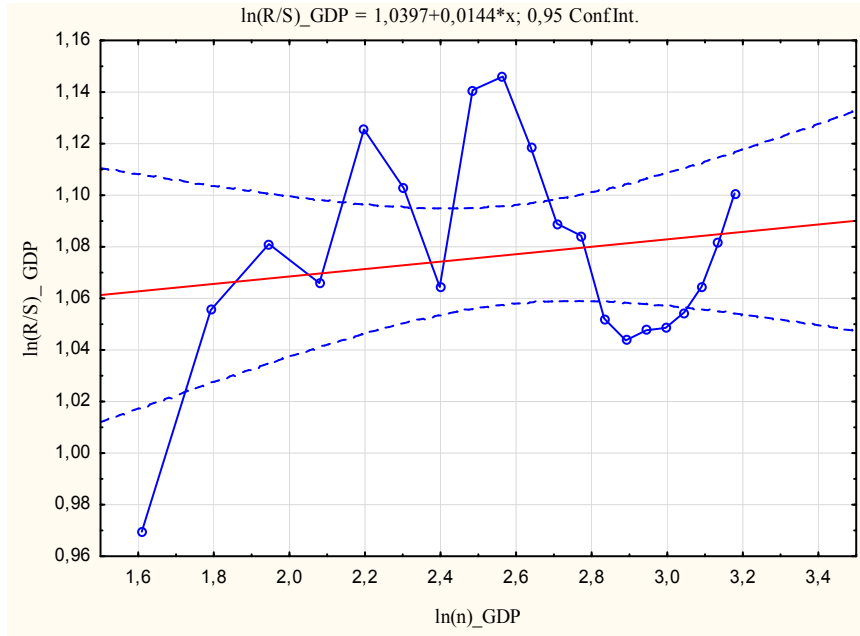

Fig. 1. Value *R/S* for GDP.

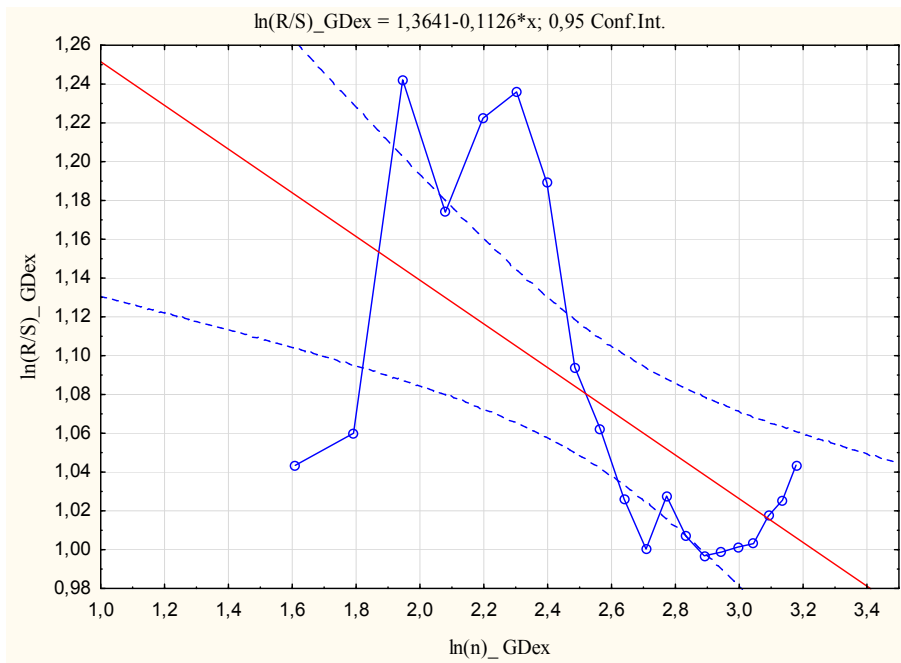

Fig. 2. The ratio *R/S* for gross external debt.

The calculated Hurst indicator for GDP is 0.014, which means that the GDP is anti-persistent and unstable (Fig. 1). A number of gross external debt is also anti-persistent and unstable ($H = 0.11$) (Fig. 2).

The above calculations point to the volatility of the dynamic series of key macroeconomic indicators of economic development.

Also, the stability of the financial system of the economy can be checked with the help of the provisions of econophysics. The possibility of using models borrowed from physics in the study of economic problems is considered in many works of scientists, where it is proposed to use not only the concepts borrowed from statistical physics but also classical mechanics in the study of economics.

To determine stability, it is offered using the concept of equilibrium. From the second law of Newton it follows that if the vector sum of all forces applied to the body is zero, then the body retains its speed unchanged. In particular, if the initial velocity is zero, the body remains unchangeable.

Let us assume that the force that wants to shift the economy from a stable state in our coordinate system (financial stability) is the amount of gross external debt, and the force that opposes it is the volume of GDP. Then, in order for the financial system of the country to remain in a stable state, it is necessary that the ratio of gross debt to GDP does not exceed 1. This indicator is called the coefficient of stability of the financial system of the country.

The dynamics of the stability coefficient of the financial system of Ukraine, calculated according to statistical data, is given in Fig. 3.

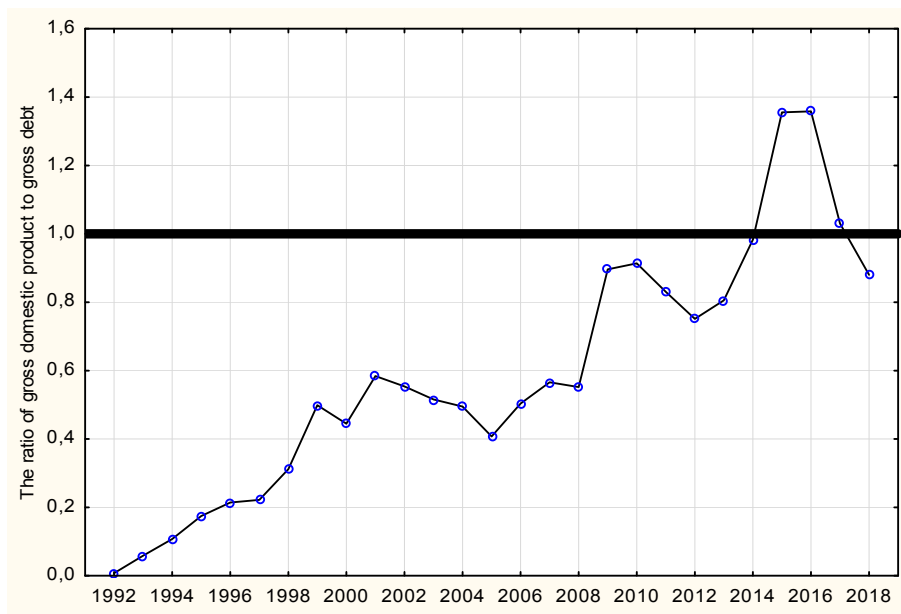

Fig. 3. The coefficient of stability of the financial system of Ukraine in 1992-2018. *Source:* Calculated by the author on the basis of [9], 2018 – preliminary data.

As it can be seen from this indicator, Ukraine's economy has been in an unstable position since 2014.

The considered approach is a bit simplistic and can serve as a quick, rapid analysis of the sustainability of the country's financial system.

Achieving an acceptable level of stability of the financial system requires the subjects of financial relations to continuously improve the measures to identify existing and potential threats and directions for their elimination in all areas of financial activity. That is why it is necessary to be able to evaluate the influence of factors on the level of financial security, which is one of the aspects of assessing the stability of the financial system of Ukraine.

In order to assess the level and dynamics of external debt load and monitor the use of external loans and loans, the National Bank of Ukraine has developed its own indicator system. It consists of 18 indicators and adequately reflects the risks that may be encountered by the banking and financial systems of Ukraine and allows us to analyze the stability of the Ukrainian financial system [11]. Calculated indicators of stability of the financial system of Ukraine are presented in Table 2.

To construct the model, we use the data in Table 2.

Since there is little statistical observation for adequate modeling, we use the bootstrap method for reproduction of the sample, which was proposed in 1977 by B. Efron of Stanford University (USA). As a result of the application of the method, 15 samples were generated. For each sample, a regression model of the dependence of the level of stability of the financial system on GDP, gross external debt, domestic debt, volumes of their servicing, exports of goods and services and consolidated budget revenues was constructed.

Formally, this dependence can be presented as:

$$I_{SF} = a + b_1GDP + b_2D_{ex} + b_3D_{in} + b_4SD_{in} + b_5SD_{ex} + b_6Ex + b_7PB, \quad (1)$$

where I_{SF} – the index of financial security level (indicator of stability of the financial system), GDP – nominal gross domestic product; D_{ex} – external public debt; D_{in} – domestic state debt; SD_{in} – domestic state debt service; SD_{ex} – servicing of external public debt; Ex – total annual export of goods and services; and PB – total annual consolidated budget revenues.

The calculations of the model parameters were carried out in the Statistica system 10 (see Table 3). On the basis of analysis of the estimated parameters for the samples, the estimations of the parameters of the model are found:

$$a = 0.5957, b_1 = 0.000004, b_2 = -0.000001, b_3 = -0.00003, b_4 = -0.00003, \\ b_5 = -0.0003, b_6 = 0.000006, \text{ and } b_7 = -0.00001.$$

Consequently, the model given by equation (1), on the basis of the estimated values of the parameters of the model adequately describes the dependence of the level of stability of the financial system on these indicators (see equation (2))

$$I_{SF} = 0.5975 + 0.000004GDP - 0.000001D_{ex} - 0.00003D_{in} - \\ -0.00003SD_{in} - 0.0003SD_{ex} + 0.000006Ex - 0.00001PB, \quad (2)$$

Let's analyze this model. Multiple determination coefficient $\bar{R}^2 = 0.9848$. Consequently, 98.48% of the variation in the level of stability of the financial system of the country is determined by the variation of the analyzed factors, and 1.52% – by the influence of unregarded factors (Fig. 4).

Table 2. Some indicators of stability of the financial system of Ukraine.

Year, 19XX/20XX	Net foreign direct investment in GDP, %	Current account deficit of balance of payments to GDP	Gross external debt to exports of goods and services, %	Gross external debt to GDP, %	Repayment and servicing of gross external debt to exports of goods and services, %	International reserves to GDP, %	Gross external debt to international reserves, %	Index financial stability
92	0.27		3.11	0.74				0.602139755
93	0.30		22.69	5.87				0.576172511
94	0.30		30.31	10.73	1.53			0.700846198
95	0.55		37.14	17.48	6.60			0.685641219
96	1.17		46.89	21.41	6.10			0.69199236
97	1.24		54.69	22.20	5.85			0.687365135
98	1.77		74.49	31.20	9.08			0.665421601
99	1.57		92.85	49.87	12.46			0.591789196
00	1.90	-0.004	71.25	44.49	15.16			0.646188543
01	2.08	-0.004	105.33	58.42	7.24	2.95	1980.66	0.482602966
02	1.63	-0.008	100.54	55.39	6.37	10.54	525.40	0.650478934
03	2.84	-0.0058	89.32	51.58	5.90	13.85	372.47	0.706279166
04	2.64	-0.0107	80.84	49.48	4.86	14.97	330.47	0.763442595
05	9.06	-0.0029	79.14	40.74	5.08	22.51	180.99	0.893836936
06	5.20	0.0015	108.01	50.36	4.91	20.75	242.71	0.712362407
07	7.14	0.0037	126.17	56.58	3.73	22.76	248.62	0.711007893
08	5.94	0.0071	117.64	55.20	2.65	17.52	314.98	0.619572418
09	4.07	0.0015	193.26	89.62	5.44	22.61	396.39	0.555813343
10	4.74	0.0022	194.22	91.39	3.22	25.42	359.49	0.569649069
11	4.42	0.0063	166.66	83.03	3.14	19.49	426.06	0.521209619
12	4.65	0.0082	212.15	75.13	7.60	13.96	538.04	0.464240679
13	2.46	0.0090	187.51	80.55	14.98	11.14	723.25	0.384400984
14	0.63	0.0034	202.25	98.28	10.54	5.64	1741.68	0.291754202
15	3.37	0.0002	256.87	135.55	30.47	14.68	923.50	0.353546944
16	3.39	0.0014	324.46	126.50	6.60	16.66	759.26	0.233569629
17	2.52	0.0022	290.80	102.94	9.75	16.77	613.83	0.42745074

Source: Calculated by the authors on the basis of statistical data [7-9]. The index financial stability is developed by the authors [10].

Statistic	Summary Statist
	Value
Multiple R	0,992460778
Multiple R?	0,984978397
Adjusted R?	0,963948152
F(7,5)	46,8362785
p	0,00029249303
Std.Err. of Estimate	0,0343026129

Fig. 4. Indicators of the adequacy of the model.

Table 3. Parameters of built models for samples.

Parameters at the indicator	Sample						
	1	2	3	4	5	6	7
	0.653719	0.682680	0.661740	0.635063	0.645879	0.657426	0.595660
GDP	0.000004	0.000004	0.000004	0.000004	0.000004	0.000004	0.000004
Gross External Debt	0.000001	0.000001	0.000001	0.000002	0.000001	0.000001	-0.000001
Domestic dept	-0.000019	-0.000020	-0.000018	-0.000020	-0.000019	-0.000020	-0.000010
Internal debt service	0.000065	0.000079	0.000063	0.000054	0.000066	0.000066	-0.000031
Maintenance of external debt	-0.000237	-0.000274	-0.000242	-0.000227	-0.000257	-0.000232	-0.000149
Export of goods and services	0.000003	0.000002	0.000003	0.000003	0.000003	0.000002	0.000006
Consolidated Budget Revenues	-0.000011	-0.000011	-0.000011	-0.000011	-0.000011	-0.000011	-0.000010

Parameters at the indicator	Sample							
	8	9	10	11	12	13	14	15
	0.648292	0.651688	0.677078	0.651688	0.674089	0.639576	0.609431	0.635501
GDP	0.000004	0.000005	0.000005	0.000005	0.000004	0.000001	0.000002	0.000007
Gross External Debt	0.000001	0.000001	0.000001	0.000001	0.000000	0.000002	0.000003	-0.000001
Domestic dept	-0.000019	-0.000021	-0.000019	-0.000021	-0.000013	-0.000030	-0.000035	-0.000012
Internal debt service	0.000071	0.000095	0.000046	0.000095	0.000048	0.000138	0.000206	0.000048
Maintenance of external debt	-0.000218	-0.000242	-0.000210	-0.000242	-0.000218	-0.000249	-0.000446	-0.000227
Export of goods and services	0.000003	0.000001	0.000002	0.000001	0.000001	0.000006	0.000004	0.000002
Consolidated Budget Revenues	-0.00001	-0.000011	-0.000011	-0.000011	-0.000009	-0.000007	-0.000005	-0.000015

Analysis of the statistical significance of the model parameters allows us to conclude that they are significant. The zero hypothesis in this case is not taken into account, because what actually means that the coefficient of determination is significant.

4 Conclusion

Consequently, model (2) can be used for further analysis. Proceeding from this, it can be stated that with an increase in the volume of gross external debt by 1 thousand dollars of US , the level of stability of the financial system of the country decreases by an average of 1 point, with the growth of GDP per 1 thousand dollars. The US level of stability of the financial system of the country increases by an average of 0.4 and with an increase in exports by 1 thousand dollars. The US level of stability of the financial system of Ukraine increases by an average of 0.6 points.

This research can serve as the basis for the adoption by the relevant state institutions of sound decisions on ensuring the stability of the financial system of Ukraine.

References

1. Monitoring of the factors that create the risks of sustainability of public finances in Ukraine. <http://ief.org.ua/wp-content/uploads/2015/05> (2015)
2. Danylenko, A.I., Zymovets, V.V.: Risks and Threats to the Security of the Public Finance Sector of Ukraine: An Analytical Report. NAS of Ukraine. 7-8 (2013)
3. The Methodology for Calculating the Level of Economic Security of Ukraine: Order of the Ministry of Economy of Ukraine dated 02 March 2007. tinyurl.com/yytexv9l (2007). Accessed 21 Mar 2019
4. Sovereign Bond Interest Rate Spreads, basis points over US Treasuries. <https://tinyurl.com/y57s6qxy> (2018). Accessed 21 Mar 2019
5. Yankovy, O.G., Goncharenko, O.M.: Analysis of Sustainable Development of Enterprises by the Normalized Scale of Hurst. *Bul. of the VPI*, **2**, 35–38 (2012)
6. Derbentsev, V.D., Serdyuk, O.A., Solovyov, V.M. and Sharapov, O.D.: Synergetic and econophysics methods for the study of dynamic and structural characteristics of economic systems. Brama-Ukraine, Cherkasy (2010)
7. Ministry of Economic Development and Trade of Ukraine. www.me.gov.ua (2019). Accessed 21 Mar 2019
8. External sector statistics. tinyurl.com/yy8wdx2h (2019). Accessed 21 Mar 2019
9. World Bank Open Data. tinyurl.com/y59qa6po (2019). Accessed 21 Mar 2019
10. Makhanets, L.L.: Estimation of the financial system stability of the country. *ONU herald*, **23**, 5(70), 185–190 (2018)
11. Panasenko, G.: Criteria and indicators of financial sector stability assessment. *Bul. of the KNUTE*, **6**, 99–110 (2010)
12. Vitlinskyi, V., Makhanets, L.: Modeling the stability of the financial system of the country. *SHS Web of Conferences*, **65**, 04015 (2019). doi:10.1051/shsconf/20196504015
13. Soloviev, V., Belinskiy, A.: *CCIS*, **1007**, 276 (2019)
14. Soloviev, V.M., Chabanenko, D.M.: Dynamika parametriv modeli Levi dlia rozpodilu prybutkovostei chasovykh riadiv svitovykh fondovykh indeksiv (Dynamics of parameters of the Levy model for distribution of profitability of time series of world stock indexes). In:

- Pankratova, E.D. (ed.) Proceedings of 16-th International Conference on System Analysis and Information Technologies (SAIT 2014), Kyiv, Ukraine, May 26-30, 2014. ESC "IASA" NTUU "KPI", Kyiv (2014)
15. Soloviev, V., Solovieva, V., Chabanenko, D.: Dynamics of α -stable Levi process parameters for returns distribution of the financial time series. In: Chernyak, O.I., Zakharchenko, P.V. (eds.) Contemporary concepts of forecasting the development of complex socio-economic systems, pp. 257–264. FO-P Tkachuk O.V, Berdyansk (2014)

Factors of Development of International e-Commerce in the Context of Globalization

Vitalina Babenko^[0000-0002-4816-4579]

V. N. Karazin Kharkiv National University, 4, Svobody Sq., 4, Kharkiv, 61000, Ukraine
vita.babenko@gmail.com

Zdzisław Kulczyk

Bronice 1. Z.Kulczyk & M.Kulczyk, civil copartnership, 68300, Lubsko, Poland

Iryna Perevozova^[0000-0002-3878-802X]

Ivano-Frankivsk National Technical University of Oil and Gas, 15, Karpatska Str., Ivano-Frankivsk, 76000, Ukraine
perevozova@ukr.net

Olga Syniavska^[0000-0002-7507-3541]

Sumy State University, 2, Rymkoho-Korsakova Str., Sumy, 40000, Ukraine
o.syniavska@uabs.sumdu.edu.ua

Oksana Davydova^[0000-0003-3045-9464]

Kharkov State University of Food Technology and Trade, 333, Klochkivska Str., Kharkiv, 61051, Ukraine

Abstract. The article discusses the theoretical foundations of the development of global e-commerce in the processes of globalization. The analysis of the definition of the concept of e-commerce, identified its varieties. The authors investigated the main trends that have developed in the e-commerce market, and provide statistical indicators. In addition, the factors that influence the process of development and distribution of e-commerce in the world are identified. Also highlighted the main problems that do not allow the process of distribution of e-commerce technology to develop the maximum rate.

Keywords: e-commerce, development, globalization, Internet economy, retail sales.

1 Introduction

The current state of the economy of any country depends largely on accurate estimation, forecast, effective planning and e-commerce management. The modern system of

Internet trading is a complex integrated organizational and production system, the components of which are constantly changing, interacting with each other. Achieving these goals in the face of growing competition between e-commerce leads to an increase in the volume and complexity of production processes, analysis, planning, management, internal and external relations with suppliers, intermediaries, etc.

However, e-commerce systems in the process of dynamic development of the company can be considered fully justified and adapted without the use of modern approaches to economic-mathematical modeling.

This, in turn, is an effective means of theoretical processing and practical synthesis of mechanisms and tools for e-commerce systems. Note that there are scientific studies devoted to the problems of e-commerce management, various economic and mathematical models and methods for finding managerial decisions. However, the problem of economics and mathematical modeling of adaptive management of electronic trading systems in conditions of uncertainty, taking into account the influence of the factor has not yet been solved and is an actual topic of the study.

The development of Ukraine's integration policy in the sphere of e-commerce depends to a large extent on the development of integration processes in the context of the globalization of the world economy and the dominance of open economic systems. Being one of the members of the world community, Ukraine can not be separated from the transformation of the recent integration processes in the sphere of e-commerce. Historical relations of cooperation, which connect Ukraine with the countries of the post-Soviet area, in particular, are undergoing serious changes due to the socio-political situation of our country over the past four years.

2 The Concept of e-Commerce

The rapid development of e-commerce creates problems for firms trying to develop e-commerce strategies. This is especially difficult given the seemingly uninterrupted flow of new information technologies and software applications. However, companies are promoting their e-commerce strategies, partly fearing that they will lose customers over competitors if they do not have e-commerce strategies [9].

Since its appearance on this planet, e-commerce has attracted much attention from scientists and researchers. There were no limitations in determining the e-commerce of scientists, researchers and other authors. Therefore, it is necessary to make a brief overview of the existing definitions of this concept.

According to Roger Clark, e-commerce is defined as the trading of goods and services through telecommunication and telecommunication tools [16].

Jerry Ellison also defines e-commerce as an electronic contract for the exchange of values using information and communications technology [10].

E-commerce is also defined as doing business online, selling goods and services that are delivered offline, as well as products that can be "digitized" and delivered online such as software [4].

Anil Khural defines e-commerce as the use of computer, Internet and general software to send and receive product specifications and drawings; applications,

purchase orders and invoices; and any other type of data that needs to be passed on to customers, suppliers, employees or the public [1].

Summarizing all the studied definitions and existing concepts, we can define e-commerce as:

1. in the narrow sense, e-commerce is financial transactions carried out through the Internet and private communication networks, during which purchases and sales of goods and services, as well as money transfers are made. A transaction in electronic commerce can be a simple confirmation of the desire and possibility of purchasing with a credit card and following the transfer of the necessary amount from one account to another;
2. in a broad sense, e-commerce is any form of business relationship where interaction between actors occurs through the use of Internet technologies [3].

Even though e-commerce has become a separate sector of the economy, much attention is paid to the legislative regulation of this concept. Thus, in 1997, in accordance with the resolution of the General Assembly of the UN adopted a Model Law “On e-commerce”. This legislation is a recommendation and, above all, should be used by the states as a basis for the development of national legislation.

So, one of the most progressive countries, where legal regulation of e-commerce relations began, is the United States. The current legislation in the state “Fundamentals of Global E-Commerce” regulates the following aspects of relations in the field of electronic commerce:

1. the transformation of the global Internet network on environment, subject to market laws and mechanisms for the implementation of communications and the redistribution of goods and services between different entities;
2. promotion of the development and use of electronic payment systems for the full “digitization” of payments;
3. promoting the development of web services for e-commerce;
4. establishment of minimal state interference in the electronic segment of the economy (the principle of self-regulation of e-commerce)
5. confronting non-tariff restrictions on e-commerce on the Internet [18, 11].

Next, other countries which hold leading positions in the field of communication and information technology (Canada, Japan, Singapore, Australia) were supported and developed all these principles according to US law in their own legislation.

It is necessary to note that in the theory of e-commerce, this sphere can be distinguished by the models selected on the basis of the parties of economic relations and on their interaction between each other. The most common among them are:

1. business-to-business (B2B) – any activity of some companies in providing other manufacturing companies with accompanying services, as well as goods and services intended for the production of other goods. This field of activity is focused on obtaining benefits (profits) from the provision of services or the sale of goods, where the “objects” are services or goods, and the “subjects” are organizations that

interact in the market field. Here organizations and (or) individual entrepreneurs act as “seller” and “buyer” of services or goods [17];

2. business-to-consumer (B2C) – the term for commercial relations between private individuals, the so-called “end” consumer. It is also a form of electronic commerce whose goal is direct sales for the consumer (end user, individual) [22];
3. consumer-to-consumer (C2C) – e-commerce of the end consumer with the end consumer, in which the buyer and the seller are not entrepreneurs in the legal sense of the word. Usually, a third party is involved in such commercial relationships – an intermediary who organizes a trading platform, such as an online auction, website-advertisements about buying/selling, etc. Also, an intermediary may be the guarantor and/or executor of the payment. The intermediary is not the guarantor of receiving goods, but in some cases may affect the resolution of controversial situations. Also, the mediator does not participate in the promotion of goods, the seller does this independently [22];
4. business-to-government (B2G) – relationship between business and government. An example of B2G-systems can serve as a system of electronic procurement, which, recently, has become especially popular in Ukraine (based on international experience in the framework of globalization processes) [22, 14];
5. consumer-to-government (C2G) – the direction which used to organize direct interaction between the government of the country and the final consumer. For example, in the US, almost all taxpayers filed a declaration of income through the sites of tax departments [22];
6. mobile commerce (m-commerce) – the process is carried out using handheld computers or smartphones via a remote (Internet, GPRS, etc.) connection. Mobile commerce, as a rule, is a software and hardware solution for automating processes of interaction with remote users [13].

3 Main Worldwide e-Commerce Trends

In general, the intensity of use by various subjects of possible e-commerce services, first of all, correlates with such indicator as the number of Internet users in the country. Let's analyze this indicator (Fig. 1).

Of course, given the high population density and the rapid spread of information technology, Asia occupies a leading position. Also, it is worth noting the countries of Europe and America, since these regions are highly developed, and the introduction of Internet technologies is part of the active improvement of business efficiency.

Talking about the retail e-commerce sales worldwide, we can see that in 2017 retail e-commerce sales worldwide amounted to 2.3 trillion US dollars (Fig. 2). The top 3 online stores' revenue (amazon.com, apple.com, walmart.com) amounted to almost 100 billion US dollars in 2017 [20].

Throughout the world, e-commerce is a much-growing area without signs of a downturn in 2019 and even in subsequent years. It remains a popular choice for investment and new businesses, and further growth will foster the development of user-friendly development techniques, technologies and, of course, increased competition.

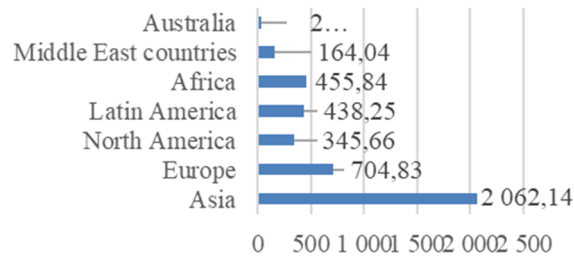

Fig. 1. The number of Internet users by the regions (01.01.2018, million people) [19].

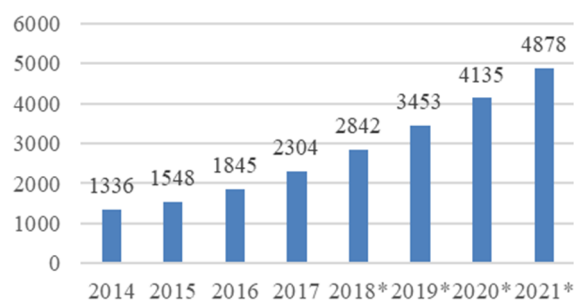

Fig. 2. Retail e-commerce sales worldwide from 2014 to 2021, * - forecast (in billion U.S. dollars) [19]

Speaking of analysis in terms of e-commerce segments, by the close of 2017, B2C e-commerce sales will hit \$2.3 trillion worldwide. B2B e-commerce, on the other hand, will reach \$7.7 trillion. Those two data points represent a 234.78% difference in market size [8].

Given the growth in globalization, the fact that the US share in global e-commerce sales is steadily declining is not shocking at all. However, many enterprises do not consider how fast this decline really does.

Where the United States once reigned in e-commerce, it is expected that by 2020 their share will be 16.9% (compared with 22.2% in 2015).

As a result, the lion's share of global e-commerce sales of B2B, in particular (84%), currently resides outside of the western continent, such as North America and Europe (16%).

If the rapid growth of other countries is not enough to stimulate the support of an international approach, the easing of the West is another way to wake up any unwilling team members or leaders.

An analysis of the share of e-commerce in global retail sales volumes also shows a tendency for rapid growth (Fig. 3).

Conducting an analysis of the e-commerce market in the context of existing e-commerce models shows that B2B global sales reach \$7.7 trillion USA in 2017 (Fig. 4). So, B2B e-commerce market is more than twice bigger than B2C, and it continues to grow.

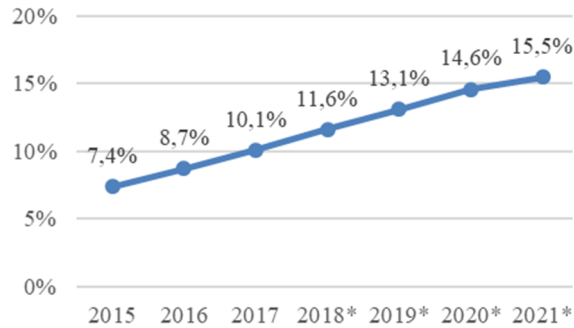

Fig. 3. E-commerce share of total global retail sales, * - forecast [19]

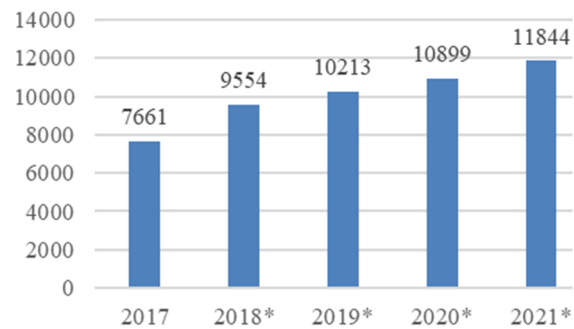

Fig. 4. B2B e-commerce volume, * - forecast (in billion U.S. dollars) [19]

Given that Ukraine is also actively joining integration into globalization processes, it also occupies not the last positions in the rate of penetration of Internet technologies. In general, about 67% of Ukrainian Internet users visit websites related to e-commerce. If to analyze the growth rate of e-commerce in Ukraine, then they, in recent years, far exceed the growth rate in Europe. This is primarily due to a sharp increase in the level of Internet penetration in Ukraine, as well as the distribution of Internet users by age and income. So, for users with income levels above the average, it reaches almost 100%, a similar situation in the age group 15-45 years, which provides a significant proportion of active Internet buyers [19]. Also, experts note that in 2017 only 9% of Internet users did not buy nightly Internet. Thus, the overall growth in e-commerce has allowed Ukraine to gain primacy among European countries in 2016-2017. This trend will continue for no more than 2 years, as the growth rate of the penetration rate of the Internet decreases as its absolute value increases. This, in turn, has a significant impact on the dynamics of online commerce volumes [19].

4 e-Commerce and Globalization

It is expected that globalization and e-commerce will change the economic structure of nations. The expected economic surplus is mainly influenced by the two above-

mentioned factors. In literature, the new structure is usually called knowledge economy, new economy or e-economy [1]. E-commerce not only reduces communication costs, but also increases the flexibility to find actions.

Globalization of the firms is announced as a key factor in the spread of e-commerce. It is expected that large global companies are likely to use e-commerce more intensively than less global firms. Companies, faced with foreign competition, are under great pressure to adopt technologies such as e-commerce that will allow them to protect or expand market share and work more efficiently.

Companies conducting business outside their own country may be more interested in lowering operating costs (such as information search, negotiation and performance monitoring) with the help of information technology. With the help of the Internet for transactions and coordination, it can save time and money on delivery of goods, using rich information flows to simplify and optimize the flow of physical goods in the supply chain.

It is often assumed that the introduction of e-commerce is a global process managed by a common set of participants. However, there is a theoretical basis for the assumption that some industries and activities will seek global convergence, while others will be marked by local differences [2].

Based on a combination of theory and empirical findings, we assume that globalization has a different impact on the introduction of e-commerce between B2B and B2C, and global companies are more involved in B2B and fewer global companies engaged more in B2C. Because B2B e-commerce is the overwhelming majority of e-commerce, as higher B2B levels implemented by global firms will be a minor advantage of local firms in B2C, which leads to greater overall acceptability of e-commerce by global firms. In this section, we can conclude that:

1. Companies that are global have a higher overall adoption rate for e-commerce.
2. Companies that are global have a higher level of adoption of B2B e-commerce.
3. Companies that are global have low B2C e-commerce adoption.

In general, the following key factors can be identified that have a significant impact on the development of e-commerce:

- Trust. Trust can be a key factor in B2C. This gives consumers confidence that they are buying goods or services, even if the electronic trader is unknown. It encourages the wider use of e-commerce technologies, facilitates the process of electronic transactions, increases the adoption of e-commerce, leads to increasing the consumer affection, increases customer satisfaction, introduces the concept of loyalty, supports a long time-relationship with customers and helps to gain a competitive advantage. Future purchases can be motivated, and price increases are permissible. This reduces customer concern about the confidentiality of information and helps clients tolerate irregular errors committed by an electronic trader [15].
- Quality. Perceived quality of goods and services has two aspects: technological, which refers to the delivered service, and functional, which refers to the way the service is provided. Response rate, offer renewal, and site performance are technical. Interactive communication in the network, personalization of communication with

the client, as well as service, development of new forms of access for customers relate to the functional aspect of quality perception. The quality of the product / service is determined by the client's perception of the quality of all available information about the product / service provided by the website.

- Government intervention. The role of the government in the development of e-commerce in the context of globalization is defined as that which facilitates the basic requirements for the development of e-commerce. These include providing secure online payment options, providing reliable ICT infrastructure, providing educational programs and raising awareness through various means, such as the media and educational institutions.
- Accessibility. As the Internet is rapidly becoming the main source of information and services, the well thought out content and design of the e-commerce website has become imperative for citizens to have constant access to public information and increase their participation. E-commerce sites today can serve as a tool for communication and for relationships with customers and the general public. Information and personal data can be easily transferred to external stakeholders [12]. In addition, scientists define the availability of the Internet as an incentive for people to use, perceive, understand, direct and interact with the network and the outside world. International Standardization Organization (ISO) has identified accessibility as "the convenience of using a product, service, environment or object with the widest range of opportunities".

5 Existing Problems in the Development of International e-Commerce

Despite the above factors, which have a significant progressive impact on the development of e-commerce, there are also certain obstacles that delay the process of distribution of e-commerce technology.

First of all, this is a technical barrier. Many technical difficulties still prevail and are clearly seen as major challenges to the growth of global e-commerce. In addition, this group of problems included problems of infrastructure development or problems at the organization level related to the integration of new e-commerce solutions into existing outdated systems, standard problems, problems related to Internet capabilities, security problems, etc.

In addition, in both the real sector and e-commerce, a process such as corruption has a significant negative impact. Corruption is hampering electronic commerce; corruption is a huge problem for international trade in general, often in connection with customs procedures, and is associated with everything from bribery to the disappearance of items. Both small and large businesses emphasize this problem. An increasing number of enterprises believe that e-commerce is particularly sensitive to corruption, as many small parties that are "easier to deploy" often go, and electronic merchants often do not have staff to be able to follow any problems. One company explained that it decided to leave the Chinese market, and the other - that it did not begin to sell to Russia because of corruption. In addition, Turkey, Ukraine and other

countries of Eastern Europe were mentioned as problematic in relation to corruption in e-commerce.

And the last, but extremely significant factor that can be identified, is the cognitive barrier. Most analysts argue that the cognitive barrier is the most serious among other forms of barriers in developing countries and countries with economies in transition. Effects such as ignorance and uncertainty serve as cognitive feedback. In most developing countries enterprises, technological resources, lack of awareness and understanding of the existing potential, underestimation of risk and inertia often lead to a negative assessment of the entire e-commerce system. Another reason for the cognitive barrier is unfortunately connected with the increasing general and computer illiteracy and the lack of English language skills. It is known that the majority of software, human-computer interfaces and content on the Internet is available in English. It is estimated that more than half of the population of developing countries and countries with economies in transition (including Ukraine) cannot speak the official language (in English) of their countries, especially the older generation.

Speaking specifically about Ukraine, the country is actively increasing its position in world rankings related to the speed of the introduction of e-commerce. But for Ukraine, as well as for other transition economies, the main barrier for the further development of e-commerce is the presence of large foreign players. The biggest “problem” is the growing popularity of such a service as AliExpress. It can also be explained by a wide choice of offers, better services, the ability to pay hryvnia credit cards and being lower than the price offers. The difference in prices on foreign and domestic sites reaches 100%. Since February 2017, this company has changed the conditions of delivery to Ukraine altogether, canceling free delivery, but in return it provided consumers with the opportunity to track the passage of goods all the way from the seller to the buyer. According to a study [6], the majority of buyers agree to pay extra for this option, as well as for speeding up the delivery, since prices, however, turn out to be much lower.

6 Investigation of the Factors of Influence on Integration into the World e-Commerce Market

An important part of the study of the prospects for the development of country's integration into the international e-commerce system is the process of selecting a system of indicators that will allow to assess such integration.

The introduction of the principles of e-commerce in business relationships of any level is subject to many factors. The most important factors are the general state of the country's economy; the world market situation; the economic status of major partners; level of state regulation of foreign economic activity [2]. To characterize these factors and assess their impact on country's integration processes in the international e-commerce system, it is important to choose appropriate set of indicators. Since the main focus of e-commerce is mainly on trade activity, this system of indicators will be such that determines the trade and economic status of integration associations: x_1 – export within the association; x_2 – total export; x_3 – import within the association; x_4 –

total import; x_3 – direct foreign investments, internal and external flows and reserves (annual); x_6 – GDP; x_7 – total annual trade; x_8 – total volume of trade; x_9 – balance of payments, current annual operations accounts.

In order to establish the importance of the impact of selected economic development indicators on the differentiation of integration associations, we will construct a discriminatory function (for standardized data in 2017). Thus, the model of differentiation in the development of integration processes in the global e-commerce market in 2017 has the form:

$$f(x) = -8.67098x_1 - 6.36273x_2 - 9.60139x_3 + \\ + 21.273x_4 + 1.50212x_5 - 5.68611x_6 - \\ - 11.567x_7 - 0.450606x_8 + 0.167332x_9.$$

The analysis of the weighting coefficients obtained as a result of the discriminant analysis allows us to draw certain conclusions regarding the impact of the factors in integration processes:

$$x_4 > x_7 > x_3 > x_1 > x_2 > x_6 > x_5 > x_8 > x_9.$$

Thus, the constructed model and the carried out quantitative analysis allow us to see a significant difference in the importance of the influence of certain factors on the process of integration of the regions of the world into the system of international e-commerce.

7 Conclusions

E-commerce technology has helped companies differently. This not only helped businesses and firms sell their products and services around the world and easily, but also helped customers make purchases at any convenient time and everywhere.

Since its existence, until now, there were no restrictions on the search for advanced technologies that would meet the current situation of e-commerce by experts and enterprises. This means that the e-commerce we see today will not be the same in the next five years. E-commerce will see enormous growth and advances in technology, as it continues to grow stronger in business both in developed and developing countries.

As they say, “growing brings many benefits and problems”, so we have to put ourselves in a better position to cope with the challenges that accompany the growth of e-commerce technologies.

In this paper the main factors and key problems of development of international e-commerce under the conditions of globalizations were defined. In addition, a discriminant analysis of selected factors was conducted and a model of differentiation in the development of integration processes, on the basis of which we can clearly see the importance of selected indicators in the process of integration into the world e-commerce market, was calculated. Also, it is proved that Ukraine is not an exception and also follows the trends in the introduction of e-commerce methods in all forms of business. The processes of globalization have also touched the online sphere, which

will undoubtedly become the driving force in the development of this sphere and, possibly, the smooth displacement of the relative sector.

References

1. Anil, K.: Introduction to e-commerce. <http://www.ddegjust.ac.in/studymaterial/mcom/mc-201.pdf> (2019). Accessed 2 Mar 2019
2. Babenko, V., Pasmor, M., Pankova, Ju., Sidorov, M.: The place and perspectives of Ukraine in international integration space. *Pr. and Persp. in Man.* **15**(1), 80–92 (2017). doi:10.21511/ppm.15(1).2017.08
3. Babenko, V., Syniavska, O.: Analysis of the current state of development of electronic commerce market in Ukraine. *Tech. Aud. and Prod. Res.* **5**, 40–45 (2018). doi:10.15587/2312-8372.2018.146341
4. Coppel, J.: E-Commerce: Impact and policy challenges. *OECD Ec. Dep. Work. P.* **252**, 45–60 (2000)
5. Efendi, J., Kinney, M.: Marketing Supply Chain Using B2B Buy-Side-E-Commerce Systems: Does Adoption Impact Financial Performance? *Ac. of Mark. St. J.* **17**(2), 73–81 (2013)
6. European B2C E-commerce Report. <https://www.ecommerceurope.eu/app/uploads/2016/07/European-B2C-E-commerce-Report-2016-Light-Version-FINAL.pdf> (2017). Accessed 2 Mar 2019
7. Global B2C E-commerce Report. https://www.ecommercewiki.org/wikis/www.ecommercewiki.org/images/5/56/Global_B2C_Ecommerce_Report_2016.pdf/ (2017). Accessed 3 Mar 2019
8. Global Ecommerce: Statistics and International Growth Trends (Infographic). <https://www.shopify.com/enterprise/global-ecommerce-statistics> (2018). Accessed 12 Mar 2019
9. Jason, H., Frank, D., Jay, A.: Adoption of E-commerce strategies for Agribusiness Firms. In: Selected paper at the American Agriculture Economics Association Annual Meeting. Tampa (2000)
10. Allison, J.: E-commerce: Exactly what is it. <http://www.drjerryallison.hubpages.com> (2015). Accessed 13 Mar 2019
11. Melnichuk, O.S.: Global tendencies of development of e-commerce. *Sc. Works of NDFI.* **1**(66), 58–69 (2014)
12. Moon, M.J.: The Evolution of E-Government among Municipalities: Rhetoric or Reality?. *Pub. Admin. Rev.* **62**(4), 424–433 (2002)
13. Nanehkaran, Y.: An Introduction To Electronic Commerce. *Int. J. of Sc. & Tech. Res.* **2**(4), 190–193 (2013)
14. Nemat, R.: Taking a Look at Different Types of E-commerce. *W. App. Prog.* **1**(2), 100-104 (2011)
15. Pittayachawan, S., Singh, M., Corbitt, B.: A multitheoretical approach for solving trust problems in B2C e-commerce. *Int. J. of Net. and Vir. Org.* **5**(3), 369–395 (2008)
16. Clarke, R.: Electronic Commerce Definition. <http://www.rogerclarke.com/EC/ECDefns.html> (2015). Accessed 12 Mar 2019
17. Sheremet, A.D.: Forms of e-commerce and its composition in the digital economy. *Bul. of Dnip. Nat. Un. of Rail. Tr. N. after. Ac. V. Lazaryan.* **41**, 311–315 (2012)
18. Sydorova, O.V.: Regulation of e-economic activity in foreign countries. *Prob. of the Mod. Ec.* **2**, 97–100 (2011)

19. The Statistical Portal. <https://www.statista.com/> (2019). Accessed 13 Mar 2019
20. Top online stores by revenue. <https://ecommercedb.com/en/ranking/ww/all> (2019) Accessed 13 Mar 2019
21. Totonchi, J., Kakamanshadi, G.: Globalization and E-Commerce. Paper present at the 2nd International Conference on Networking and Information Technology, 2011
22. Tsarev, V.V., Kantarovich, A.A.: Economics, organization and planning of commercial activities of Internet companies (2001)
23. Babenko, V., Kulczyk, Z., Perevosova, I., Syniavska, O., Davydova, O.: Factors of the development of international e-commerce under the conditions of globalization. SHS Web of Conferences. **65**, 04016 (2019). doi:10.1051/shsconf/20196504016

Optimizing the Income of a Crewing Company

Larysa Ivashko^[0000-0002-3921-9072], Tetiana Zhuravlova^[0000-0002-4235-1955]

Odessa I. I. Mechnikov National University, 2, Dvoryanska Str., 2, Odesa, 65000, Ukraine
ivashkolm@ukr.net, yutal0606@gmail.com

Yuliya Zhuravlova^[0000-0003-4794-7691]

Odessa National Economic University, 8, Preobrazhenska Str., Odesa, 65000, Ukraine
yunik121501@gmail.com

Abstract. The article analyzes the status, trends and prospects of the development of the world labor market in the field of the maritime fleet, which makes it possible to determine that for this particular segment, characterized by stable dynamic development in the presence of significant reserves. The theoretical and practical aspects of formation and development of the market of crewing services in Ukraine are also covered. The paper considers such an important task as the selection of the optimal crew for ships' shipowners in order to maximize the income of the crewing company. The economic-mathematical model of optimization of the process of selection of crews of ships was constructed. In this case, the crewing company, which has completed the work on selecting the optimal crew, receives income as a percentage of the remuneration chosen through the model of the crew for the first month of his work. The more qualified this crew, the greater the income will receive a crewing company.

Keywords: maritime labor market, crewing company, selection of personnel, economic and mathematical modeling.

1 Introduction

Ukraine is a maritime state and famous supplier of skilled marine personnel in the international labour market. Each year, about 69 thousand Ukrainian sailors occupy their places in the felling and technical departments of ships around the world. By level of professional training, communication skills and discipline Ukrainian sailors occupy one of the first places in the world, yielding only to Filipinos, sometimes to the Chinese. In addition, 56% of all hired frames are team members. But due to the difficult way of employment without crewing companies, a significant number of maritime workers remain unemployed. The same problem exists in shipping companies: without crewing companies is difficult to communicate to seamen with the required qualifications. Ship-owners are interested in ensuring that their ships are equipped with a highly skilled crew; seamen have an interest in getting paid jobs on board shipowners; intermediary companies see their interest in meeting the needs of both the shipowner and the seaman,

as well as obtaining income from their activities. The competitiveness of shipping companies directly depends on the effective functioning of the crewing company. The professionalism of the crewing company is evaluated not only by the ability to satisfy customers' requests, but also to adjust them according to market realities and offer different ways of their satisfaction. Income derived from the recruitment of crew ships – this is one of the main indicators of the crewing agency (as well as any other company). Therefore, the most important for crewing companies is the task of optimal distribution of crew members, for which it is expedient to use economic and mathematical modeling.

Selection of crews of ships is an important part of the operations of the crewing company and an interesting task for the application of economic-mathematical modeling. Optimization of the selection of crews of ships received much less attention in the academic literature. In the works of the named scientists proposed management options for solving this problem. Therefore, the purpose of the study is to apply economic and mathematical modeling for optimal manning crewing company crews of ships sailors required qualifications to maximize its revenue.

Crewing is part of the international maritime industry. The word comes from the English crew – the team. It also deals with the complete set of commands. Unlike low-skilled professionals who are in demand in different countries, crewing deals with professionals in maritime professions. They graduated from the profile, usually higher education institutions, have long experience in managing the courts or their systems, know English, international law within their responsibilities, experience in communicating with representatives of different peoples. Of all the specialists selected for work, two thirds – the command staff. But even at the level of ordinary sailors have their own peculiarities. These are people who intend to climb up the service stages. The vast majority of them are studying and practicing on ships. Therefore, crewing is not like recruiting companies, even at recruitment agencies. Indeed, their responsibilities include not only the selection of personnel, but their testing for compliance.

Improvement in maritime education never stops. The demand for graduates of Ukrainian marine higher education institutions and institutions of secondary education is very high. Many foreign companies that have long-term programs of using Ukrainian sailors on their ships invest significant funds in training through their own “cadet programs”, providing sponsorship to marine training institutions, setting up their own training centers for the further training of seamen immediately before the voyage. Within the framework of cadet programs companies together with educational institutions conduct selection of cadets in accordance with the requirements of the company (knowledge of English, training, availability of necessary certificates), organize planning and control of the implementation of the program of floating practice on ships. In addition, the company assumes all the costs associated with the practice (flights, transfers, accommodation on board and in hotels, visa support, insurance, medical care, food, salary in accordance with the terms of an individual contract, practice on board ship). The most active in this area are the following companies in the Ukrainian market: V. Ships (Monaco), MSC Mediterranean Shipping Company (Switzerland), Bernard Schulte Shipmanagement Ltd., Peter Doehle Schiffanrts-KG, Marlow Navigation, Reederei BlueStar (Germany), Wagenberg Shipping BV, Stolt-

Nielsen Transportation Group BV (Norway), Maersk Ship Management (Denmark), ASP Ship Management Group (Australia), Anglo-Eastern Ship Management (Singapore) and others [1].

Consider the types of crewing companies. Therefore, in pure creeping, if the seaman-candidate meets the requirements of the shipowner, he is taken to work and, after a certain period of time, is sent to the ship specified by him, where he begins to fulfill his labor duties. The intermediary firm for the employment assistance assisted receives a pre-defined remuneration from the client who contacted to it. This is usually either a fixed amount or a percentage of the basic salary of a sailor employed by a ship under a particular flag without the client's financial expenses incurred by the intermediary firm.

Crewing management is the more complex form of crewing that occurs on the international seamen's and maritime professionals' market. His point is that the shipowner completely transfers to the intermediary company the responsibility for resolving all issues related to the manning and management of the ship's crew. Crewing management can: Assist in arranging the necessary visas, processing sub-documents, booking air tickets, as well as informational and consulting support, conducting or organizing training or training of seamen, sending a candidate for a medical examination, engaging in the supply and sewing of work clothes, with trade unions and public organizations, etc. Also, companies can pay crew wages, draw up and maintain a timetable for changes to the crew, and more. In this case, the shipowner pays to the firm the intermediary a pre-determined fixed monthly cash sum, at the expense of which reimbursed expenses for wages, overtime pay, various additional payments and bonuses. These include: organizational expenses for servicing the crew, its delivery to the port of destination on board the ship; exchange with the Maritime Administration of the Flag State of the presented diplomas and qualification certificates; expenses on insurance of crew members from accidents; payment for crew on board; payment of working clothes and personal protective equipment, etc. The difference between the actual costs incurred by the intermediary company and the compensation paid by the shipowner as compensation for the costs incurred is the net profit of the intermediary company.

The international labor market for seamen and marine specialists has become widespread and an organizational form of mediation in employment, such as the creation of a shipowner or group of shipowners representation in those foreign countries, where mainly the recruitment of personnel of crew of ships. For example, today the company V-Ships represents 79 offices in 33 countries, 1200 ships and 25 thousand sailors, one third of who are Ukrainians. It is this part that is the merit of the office of Igor Safin (Managing Director of V-Ships), who managed to raise the level of recruitment from 700 to seven thousand Ukrainian seamen per year in 10 years [1]. Therefore, a seaman who is in need of employment, receives work directly from the hands of a potential employer. Among the hundreds of intermediary firms engaged in the employment of seamen, there are those that are created in Western Europe. These firms, as a rule, show a high organizational level.

Consequently, the elementary forms of pure creeping were transformed into new, integrated forms of service for shipowners and seamen, ranging from recruitment and training of personnel to management ship of shipowners. In this case, the shipowner

loses the need to maintain expensive services engaged in the technical and commercial exploitation of ships. In addition, he receives a guaranteed source of replenishment of the staffing of crews of ships, which is characterized by stability and subject to control. The intermediary company, which owns a well-designed questionnaire for applicants for mariners, can respond quickly and flexibly to shipowner inquiries regarding the crew of ships. Currently, crewing companies and their branches are available in any port city of Ukraine: Odessa, Chornomorsk, Yuzhne, Mykolaiv, Izmail, Mariupol, Kherson and others. The number of crewing companies in the four largest supplier countries of the maritime labor force of the former USSR is as follows: Ukraine has 374 agencies in 2009, 450 in 2018; Russia – 176; Latvia – 59; Lithuania – 7. Given the relatively small number of seamen in the Baltic countries and the less attractive work at sea for EU citizens, the Baltic agencies are actively recruiting sailors from Ukraine and Russia [2].

In recent years, there has been a process of active entry of large foreign companies into the Russian and especially Ukrainian market: the opening of representative offices, as well as the absorption of local companies in order to join them in the global office system. Ukraine has all the key European players in the market for crewing services, as well as a significant number of companies from the Asian region. In addition, a significant number of large shipping companies have opened their offices, which are also engaged in recruiting staff. The presence of foreign capital is increasingly felt in the Ukrainian market and slightly less in the Russian market. If in the early 2000s almost all companies were independent, then the process of entering the network of offices of international crewing agencies began to take place the so-called globalization.

Authoritative international organizations BIMCO and ISF prepare a joint study of the labor market in the world maritime trading fleet every five years – Manpower Report. Such studies have been conducted since 1990. The latest Manpower Report was presented in May 2016 [3]. This study helps to assess the role and place of Ukrainian seamen in the world maritime labor market. In our country, such studies are not conducted, and on the question of how many Ukrainian seamen working on ships of the world navy fleet, different answers can be received at various instances. For example, in the spring of 2018, the Ministry of Infrastructure officially voiced a figure of 150 thousand. So many Ukrainian sailors, according to the ministry, today operate in the fleet [1]. Manpower Report 2016 from BIMCO and ICS calls quite different numbers. According to BIMCO and ISF, Ukraine continues to be part of a group of countries leaders in supplying seamen to the world fleet. According to the report, in Ukraine, 234,923 people are sailors, but 69,000 sailors were actually delivered to the fleet in 2015, in addition to 39,000 officers and 30,000 ordinary [2, 4]. In essence, it is about the number of jobs occupied by Ukrainian sailors in 2015. This is the sixth place in the world after China (243.6 thousand), the Philippines (215.5 thousand), Indonesia (143.7 thousand), Russia (97 thousand), and India (86 thousand) (Table 1).

But the population of all above mentioned countries significantly exceeds the population of Ukraine. And if we take such an indicator as the share of jobs occupied by sailors in the population of these countries, then Ukraine will be in second place after the Philippines. By % of officers among the total number of seamen, Ukraine came

second only to India. Thus, every 20th officer of the merchant fleet in the world – from Ukraine. If we talk about the countries of Europe, then among them Ukraine is a leader.

Table 1. Countries are the largest suppliers of seamen to the labor market.

Country	Population (2015 year)	Number of seamen	Number of officers	% officers of the country among all officers	% officers among the total number of seamen	% sailors to population
China	1.4 billion	244 thousand	102 thousand	13.1	42	0.017
Philippines	105 million	216 thousand	73 thousand	9.4	34	0.205
Indonesia	264 million	144 thousand	51 thousand	6.7	35	0.054
Russia	144 million	97 thousand	48 thousand	6.2	49	0.067
India	1.3 billion	86 thousand	70 thousand	9	81	0.006
Ukraine	44 million	69 thousand	39 thousand	5	57	0.156

Source: compiled by the author on the basis of [2, 3, 4]

BIMCO and ISF also publish information on the number of seamen in the world fleet, according to shipping companies. In this rating Ukraine is already fourth in China, the Philippines and Russia. Unfortunately, there is no statistics on the number of seamen in Ukraine. The only official data that can be used for some sort of orientation is the Seafarers' Training and Certification Inspection, which maintains a register of documents issued to seamen, and certificates giving the right to occupy certain positions in the fleet. According to the register in October 2017, such operating documents issued about 112 thousand [2].

There are about 450 crewing companies in Ukraine who are engaged in the supply of seamen abroad. Almost every major shipping company is guided by 5-10 different countries from where seamen are recruited from its ship. It is believed that China overtook the Philippines as the largest source of supply for seamen qualified for international trade. Although the Philippines is still the largest source of supply to the private shipping fleet [2]. However, data from international shipping companies suggests that the use of Chinese seamen to service foreign ships may be limited; since the Philippines and Russia are seen as equally important sources of officers, while Ukraine and India are following them firmly.

During the last five years, the global supply of seamen has increased, and the number of qualified officers and ordinary people operating in the international merchant fleet continues to grow. It was reported that from 2005 to 2010, the number of officers increased by 34%, and now it is estimated to increase by 24% over the past five years. The total demand for seamen in 2015 was estimated at 1 545 000 seamen: about 790.5 thousand officers and 754.5 thousand ordinary. Demand for officials increased by about 24.1% from 2010, while demand for ordinary people increased by about 1.0%. The estimation of demand for officials and ordinary persons in 2015 as compared to the

demand estimate presented in the previous reports is given in Table Estimated global demand for seafarers 2005-2015 [3]

Thus, if the expected demand for officials and ordinary people increased between 2005 and 2010 by 33.8% and 27.5%, respectively, then the demand for officers continued, with only a slight increase in demand for ordinary people from 2010 year [3].

Estimates prepared for the 2015 report indicate that the current seamen global offer is about 1 647 500 seamen, of which approximately 774 000 are officers and 873 500 are seamen, and that the current world demand for seafarers is about 1 545 000 seamen, besides, the industry needs about 790.5 thousand officers and 754.5 thousand ordinary people. The current situation is as follows: a deficit of 16,500 officers and an excess of 119 000 ordinary people, with a total surplus of 102 500 seamen. This information is presented in the Table Current estimated global supply and demand of seafarers [3].

It is estimated that the level of employment and training of specialists over the past five years has increased. The basic forecast for the future supply and demand balance is calculated based on the information and data received for the 2015 report. It consists in the fact that the global supply of officers will steadily increase, but there will be a surging rising demand for officers. This is evidenced by data of the Tables Estimated supply-demand balance for officers [3].

The 2015 report indicates that the global merchant fleet is expected to grow in the next ten years, and demand for seamen is likely to continue to tend to general shortage offerings of officers. ICS and BIMCO predict that if the level of training is not significantly increased, the growth in demand for seamen could lead to a serious shortage of officers. Some officer categories are particularly scarce, in particular, engineers, managers, and officers for specialized ships such as chemicals, etc. The shortage of seamen will be observed despite the improvement in recruitment and training and the reduction in staffing levels over the past years. It should not be expected that there will be a lot of proposals from qualified and competent seamen in the future, even taking into account coordinated efforts and measures to address key human resource problems. It is important to promote a career in the sea, to strengthen maritime education and training all over the world, to address the conservation challenges of seamen and to continue to monitor the global supply and demand of seamen on a regular basis. Without continuing efforts to promote a career at sea and to improve recruitment and staffing, it is impossible to guarantee that a large number of skilled and competent seamen will be provided in the future. According to the report, over the past five years, the maritime industry has made significant progress in increasing recruitment and training and lowering the cost of officers (retaining skilled seamen and increasing the number of years they serve at sea) [3, 5, 6, 7, 8].

Taking into account the presented analytical data it can be seen that the need for crewing services will continue to grow. The need to improve the quality of such services and improve the performance of these organizations (in particular, careful selection of personnel that meets the needs of the shipowner) is evident. Achievement of this goal will allow Ukrainian sailors to take advantage of their foreign counterparts when choosing shipowners for the required positions.

2 Development of the Optimization Model

Usually, the process of selecting a shipping crew by crewing companies specialists is carried out according to the algorithm of assessing candidates in the process of providing services by the crewing company and consists of the identification by means of modern specialized methods and technologies of a qualitative level of professional, qualification, personal characteristics, as well as motivational installations of the candidates that make up the pool. The purpose of the evaluation is to determine the numerical or descriptive values characteristics of the candidates. Candidates who constitute a pool should be evaluated using a single assessment system to obtain comparable results [9].

The selection of candidates is a professional activity, which represents the process of making a decision on the choice of certain applicants for employment in accordance with the existing staffing needs of the organization of the customer. The selection is carried out by comparing the results of the evaluation of individual candidates that make up the pool. The result of the selection is one or more candidates who will later be represented by the shipowner organizations who need personnel for employment [10]. If the seaman is successfully employed on the ship of the customer company, the crewing agent receives a remuneration from the shipowner or the occupant of the position. Most often, this is a certain amount paid for each month (or day) of the seaman's work on board, although there may also be a fixed remuneration, the size of which does not depend on the duration of the seaman's stay on board. Such payments may be paid for each contracted sailor, but some shipowners (usually in the oil and gas industry) are practicing a one-time payment for the selection of the specialist they require. Often this amount is calculated by computation the percentage of the wages of the employee they need. Accordingly, the more valuable and, accordingly, the highly paid specialist will find a recruiting firm, the greater will be the size of its remuneration [9]. It is known that the quality of services provided by crewing companies is reflected not only in the quality of satisfaction of the needs of the shipowner in the personnel, but also indirectly affects the operation of the shipping company as a whole.

In the absence of skilled personnel of the shipping company, great importance should be given to measures aimed at attracting, retaining the company and encouraging the development of a shipping crew, that is, measures of material and moral motivation. An additional method of material motivation can be the bonus system of pay, as well as the system of rewards sailor for excellent work. In practice, the main purpose of employment, as a rule, is the receipt of material remuneration. For a seaman, the highest possible earnings are associated with a number of negative non-material factors (long working day, bad working conditions, long separation from relatives, etc.). At the same time, work under such difficult conditions, besides high pay, can ensure the implementation of other competing goals (career development, professional experience, consolidation in a prestigious shipping company, etc.) [11]. Implementation of retraining and refresher training, as well as compensation of expenses for training and passing medical board, implementation of social guarantees for seamen, as well as carrying out measures to improve professional skills of recruitment managers, introduction of modern methods of testing seamen are

unconditional factors of efficiency improvement functioning of the crewing company and strengthening its competitiveness among others [9].

Therefore, the task of optimizing the selection of crews by using the application of econometric and mathematical modeling remains very relevant.

As the basis for constructing an optimization model for the selection of crews of ships of maximum qualification, we will use the economic-mathematical model of the problem of appointment. We formulate the statement of the task of selecting the personnel of the maximum qualification for each position of the ship by the crewing company [12]. According to the analysis of the respective subscribed sites and its own database, the crewing company has selected a certain number of candidates for each of the vacant positions on the ships of the shipping companies. The positions are vacant or on the ships of companies with which the crewing company has an exclusive contract for servicing certain ships, or found on pre-paid sites. The selection is carried out according to the designated services of the customer - the shipping company - the parameters: the qualitative level of professional, qualification, personal characteristics, as well as the motivational units of candidates. For example, such as: specialty; age; necessary experience and work experience on certain ships; level of qualification (checked, in particular, on simulators); availability of certificates necessary for work; compliance of the sailor period of validity with the terms of the contract; compliance with health indicators; compliance with special documents, in particular subrogation, the ability to work in a particular region under the banner of a particular country, etc. These parameters determine the qualification characteristic c_{ijk} i -th candidate for j -th position on k -th ship. That is, the efficiency of the work of each specialist in the performance of a particular type of work on a particular ship is known – c_{ijk} ($i=1, \dots, n$; $j=1, \dots, m$; $k=1, \dots, l$). Matrix of qualifying characteristics of n candidates for B_j position on l ships – C_j – presented in the table 2.

Table 2. Matrix of qualification characteristics by j -th position, C_j .

Candidates for j -th position, A_{ij}	Ships with vacancies for j -th positions				Number candidates for j -th position, a_{ij}
	S_{j1}	S_{j2}	...	S_{jl}	
A_{1j}	c_{1j1}	c_{1j2}	...	c_{1jl}	1
A_{2j}	c_{2j1}	c_{2j2}	...	c_{2jl}	1
...
A_{nj}	c_{nj1}	c_{nj2}	...	c_{njl}	1
Number of vacant staffed posts per j-th position on k-th ship, b_{jk}	b_{j1}	b_{j2}	...	b_{jl}	

Thus, n candidates have been selected A_{ij} , who can and wish to take j -th vacant position ($i=1, \dots, n$; $j=1, \dots, m$).

Let the international seamen's market (in the market sector) have available vacancies at j -th position on l ships of different shipowners, $k=1, \dots, l$. The crewing agency either already cooperates with these shipowners or has the opportunity to start cooperation with them. Let's denote through b_{jk} number of sailors, which is planned to be replaced j -th position on k -th ship. So, on k -th ship by j -th position are open b_{jk} vacancies.

Assume that the crewing agency when sending one i -th candidate by j -th position on k -th ship receives income in size d_{ijk} as a certain percentage of the seaman's salary amount q_{ijk} .

Matrix salaries of sailors at j -th position Q_j presented in the table 3.

Table 3. Matrix of salary on j -th position, Q_j .

Candidates for j -th position, A_{ij}	Salary on j -th positions			
	S_{j1}	S_{j2}	...	S_{jl}
A_{1j}	q_{1j1}	q_{1j2}	...	q_{1jl}
A_{2j}	q_{2j1}	q_{2j2}	...	q_{2jl}
...
A_{nj}	q_{nj1}	q_{nj2}	...	q_{njl}

Each sailor can be sent for only one job. And for each position, the number of specialists may be assigned in accordance with the staffing schedule of the crew of the ship, which is determined by the shipping company.

It is necessary to appoint seamen-candidates for corresponding vacant positions on ships, so that the overall efficiency of all work is maximal. That is, it is necessary to entrust each candidate with the performance of one particular work on a particular ship in order to maximize the qualification of each position. The matrix of candidate nominations for j -th position X_j presented in the table 4.

Table 4. The matrix of assignments on j -th position, X_j .

Candidates for j -th position, A_{ij}	Ships with vacancies for j -th positions				Number candidates for j -th position, a_{ij}
	S_{j1}	S_{j2}	...	S_{jl}	
A_{1j}	x_{1j1}	x_{1j2}	...	x_{1jl}	1
A_{2j}	x_{2j1}	x_{2j2}	...	x_{2jl}	1
...
A_{nj}	x_{nj1}	x_{nj2}	...	x_{njl}	1
Number of vacant staffed posts per j-th position on k-th ship, b_{jk}	b_{j1}	b_{j2}	...	b_{jl}	

This is a statement of the classical task of appointment.

Let's make an economic-mathematical model of the task.

Let's denote through x_{ijk} – fact of appointment i -th candidate on j -th position on k -th ship.

We will assume that:

$$x_{ijk} = \begin{cases} 1, & \text{if } i - \text{th candidate is appointed} \\ & \text{on } j - \text{th position on } k - \text{th ship;} \\ 0, & \text{if } i - \text{th candidate is not appointed} \\ & \text{on } j - \text{th position on } k - \text{th ship.} \end{cases}$$

Output parameters of the task of optimization of selection of frames of crews of ships:

n – number of candidates for j -th position;

m – number of positions;
 $a_{ij}=1$ – unit amount of resource: the candidate A_i can only be assigned to one j -th position;
 $b_{jk} = t$ – number of vacant staffed positions per position B_j on k -th ship;
 $s_{jk} = l$ – number of ships S_k , where vacant position B_j ;
 c_{ijk} – qualification characteristic of the candidate A_i for performance of work on the position B_j on k -th ship;
 x_{ijk} – fact of appointment or non-appointment of a candidate A_i on the position B_j on k -th ship;
 Z_j – general (total) quality characteristics of the distribution of candidates for j -th position;
 Z – general (total) quality characteristics of the distribution of candidates for all positions.
 D_j – income earned by the crewing company as % of the wages of candidates assigned to j -th position;
 D – income received by the crewing company as % of the salary of candidates appointed for all positions.

The task is to find the distribution $X_j=(x_{ijk})$ sailors on ships for each j -th position (that is, to find a matrix of appointments), which maximizes the target function:

$$Z_j=Z_j(X_j) = \sum_{i=1}^n \sum_{k=1}^l c_{ijk} * x_{ijk} \rightarrow \max \quad (1)$$

for limitations:

$$\begin{cases} \sum_{k=1}^l x_{ijk} = 1, & i = \overline{1; n}; \\ \sum_{i=1}^n x_{ijk} = b_{jk}, & k = \overline{1; l}. \end{cases} \quad (2)$$

and

$$x_{ijk} = \begin{cases} 1, & \text{if } i\text{-th candidate is appointed} \\ & \text{on } j\text{-th position on } k\text{-th ship;} \\ 0, & \text{if } i\text{-th candidate is not appointed} \\ & \text{on } j\text{-th position on } k\text{-th ship.} \end{cases} \quad (3)$$

Thus, the economic-mathematical model of selection of personnel of the maximum qualification for each position of crews of ships is represented by formulas (1)–(3).

The more highly-paid personnel will pick up the crewing company, the higher its income.

Next we will find the income received by the company as % of the wages of the candidates assigned to j -th position. Let it be fixed for today, % – 10%.

$$D_j = 0.1 \sum_{i=1}^n \sum_{k=1}^l q_{ijk} * x_{ijk} \quad (4)$$

That is, the income of the crewing from the main activity will be:

$$D = \sum_{j=1}^m D_j \quad (5)$$

In order to find the profit of a crewing company, it is necessary to deduct from the income constant V_{const} and variables V_{var} costs.

How variable costs V_{var} we consider the costs of crewing to verify the legitimacy of documents seamen (work diplomas), selected for a position on a particular ship. The fixed pay for such a service, such as checking the legitimacy of documents, today amounts to UAH 150 per person.

$$V_{var} = 150 * \sum_{j=1}^m \sum_{i=1}^n \sum_{k=1}^l x_{ijk} \quad (6)$$

The following costs are incurred for permanent creeping expenses: support for a database template, site maintenance, office rental, utility payments, salary of office workers, certification of crewing, taxes, etc.).

Consequently, we obtain a formula for finding income from the main activity of crewing.

$$P = D - V_{var} - V_{const} \quad (7)$$

With the help of constructed economic-mathematical model of selection of personnel of the maximum qualification, we will make a selection of captains for the crewing company "Alfa crewing". Let assembled to construct a model of choice of captains ($j = 1$) information is presented tablotically (Table 5 – 7).

Table 5. Matrix of qualification characteristics by $j=1$ Captain's position, C_1 .

Candidates for $j=1$ position, A_{i1}	Ships with vacancies for $j=1$ Captain's position				Number candidates for $j=1$ position, a_{i1}
	S_{11}	S_{12}	S_{13}	S_{11}	
A_{11}	0.75	0.9	0.8	0.75	1
A_{21}	0.82	0.69	0.93	0.82	1
A_{31}	0.94	0.78	0.85	0.94	1
A_{41}	0.76	0.92	0.88	0.76	1
Number of vacant staffed posts per $j=1$ position on k-th ship, b_{1k}	1	1	1	1	

Table 6. Matrix of salary on $j=1$ Captain's position, Q_1 .

Candidates for $j=1$ position, A_{i1}	Salary of the captain on the ships, thousands of dollars			
	S_{11}	S_{12}	S_{13}	S_{11}
A_{11}	8.1	9.3	8.6	8.1
A_{21}	8.8	8	9.5	8.8
A_{31}	9.6	8.4	9.1	9.6
A_{41}	8.2	9.4	9.2	8.2

The economic-mathematical model of selection of captains of the maximum qualification is represented by the formulas 8-10:

$$Z_1 = Z_1(X_1) = \sum_{i=1}^4 \sum_{k=1}^3 c_{i1k} * x_{i1k} \rightarrow \max \quad (8)$$

for limitations:

$$\begin{cases} \sum_{k=1}^3 x_{11k} \leq 1, \\ \sum_{k=1}^3 x_{21k} \leq 1, \\ \sum_{k=1}^3 x_{31k} \leq 1, \\ \sum_{k=1}^3 x_{41k} \leq 1, \\ \sum_{i=1}^4 x_{i11} = 1, \\ \sum_{i=1}^4 x_{i12} = 1, \\ \sum_{i=1}^4 x_{i13} = 1. \end{cases} \tag{9}$$

and

$$x_{ijk} = \begin{cases} 1, & \text{if } i - \text{th candidate is appointed} \\ & \text{on } j = 1 \text{ position on } k - \text{th ship;} \\ 0, & \text{if } i - \text{th candidate is not appointed} \\ & \text{on } j = 1 \text{ position on } k - \text{th ship.} \end{cases} \tag{10}$$

Table 7. The matrix of assignments on $j=1$ Captain’s position, X_1 .

Candidates for $j=1$ position, A_{i1}	Ships with vacancies for $j=1$ Captain’s position				Number candidates for $j=1$ position, a_{i1}
	S_{11}	S_{12}	S_{13}	S_{11}	
A_{11}	x_{111}	x_{112}	x_{113}	x_{111}	1
A_{21}	x_{211}	x_{212}	x_{213}	x_{211}	1
A_{31}	x_{311}	x_{312}	x_{313}	x_{311}	1
A_{41}	x_{411}	x_{412}	x_{413}	x_{411}	1
Number of vacant staffed posts per $j=1$ position on k-th ship, b_{1k}	1	1	1	1	

The results of implementing the model in the Excel environment are shown in the figure 1.

Therefore, in order for the overall qualification of candidates for the position of the captain to be maximal, they should be assigned as follows: will receive the appointment of Captains 2, 3 and 4 candidates; 1 candidate will not receive a job this time; all vessels, on which the vacant position of the captain was, will be provided by the performers of work (J3-J6). In addition, the profit of the crewing company will be 2.85 thousand dollars (H8).

Similarly, it is possible to distribute candidates for all vacant positions of crews of vessels. Therefore, crewing company “Alfa crewing” it is expedient to apply economic-mathematical modeling for management of selection of personnel in order to maximize the overall qualification characteristic. The use of such a toolkit allows you to determine who and on what ship to appoint to one or another position in order to maximize profitability.

3 Resulting and Conclusions

Thus, we can formulate conclusions about the conducted research. The model of optimization of the selection process for crews of ships can be applied for distribution

of personnel to ship of any categories, including bulk carriers, tankers, container carriers, etc.

	A	B	C	D	E	F	G	H	I	J
1	Qualification characteristics by j=1 Captain's position					Assignments on j=1 Captain's position				
2	Candidates for j=1 position	S11	S12	S13	Number candidates for j=1 position	Candidates for j=1 position	S11	S12	S13	Number candidates for j=1 position
3	A11	0,75	0,9	0,8	1	A11	0	0	0	0
4	A21	0,82	0,69	0,93	1	A21	0	0	1	1
5	A31	0,94	0,78	0,85	1	A31	1	0	0	1
6	A41	0,76	0,92	0,88	1	A41	0	1	0	1
7	Number of vacant staffed posts per j=1 position on k-th ship	1	1	1		Number of vacant staffed posts per j=1 position on k-th ship	1	1	1	
8	Candidates for j=1 position	Salary of the captain on the ships, thousands of dollars			Z1	2,79	D1	2,85		
9		Q11	Q12	Q13						
10	A11	8,1	9,3	8,6						
11	A21	8,8	8	9,5						
12	A31	9,6	8,4	9,1						
13	A41	8,2	9,4	9,2						

Fig. 1. The result of the selection of personnel of the maximum qualification for position of captain

The model can be applied to create on its basis models of decision support systems.

The results of the study can be used by the managers of crewing companies, managers and employees of the services of work with the personnel of shipping companies.

The practical significance of the study is that the use by the crewing companies of the proposed recommendations for the application of methods of economic and mathematical modeling for the selection of skilled personnel for each position will increase the efficiency of the organization of the work of the crew of ships, as well as optimize the income of the crewing company. Optimization not only increases the efficiency of the crewing company, but also increases its responsibility. After all, the quality of services provided by crewing companies reflects not only the quality of meeting the needs of shipping companies in the personnel, but also affects both the quality of service provided by shipping companies and the efficiency of the operation of shipping companies in general.

References

1. Prylypko, O.: Natsionalnyi kriuin: vid siroho do biloho (National crewing: from Gray to White). <https://day.kyiv.ua/uk/article/ekonomika/nacionalnyy-kryuying-vid-sirogo-dobilogo> (2015). Accessed 20 Feb 2019
2. Miyusov, M.: Perspektivy podgotovki i trudoustroystva moryakov (Prospects for training and employment of seafarers). <https://ports.com.ua/articles/perspektivy-podgotovki-i-trudoustroystva-moryakov> (2018). Accessed 22 Feb 2019
3. International Chamber of Shipping: MANPOWER REPORT: The global supply and demand for seafarers in 2015. <http://www.ics-shipping.org/docs/default-source/resources/safety-security-and-operations/manpower-report-2015-executive-summary.pdf> (2018). Accessed 22 Feb 2019
4. Ilnitskiy, K.: Ukraina zanyala shestoye mesto sredi stran-postavshchikov moryakov (Ukraine ranked sixth among the countries-suppliers of sailors). <https://ports.com.ua/articles/ukraina-zanyala-shestoe-mesto-sredi-stran-postavshchikov-moryakov> (2018). Accessed 25 Feb 2019
5. International Chamber of Shipping: Annual-review-2018. <http://www.ics-shipping.org/docs/default-source/resources/annual-review-2018.pdf?sfvrsn=14> (2018). Accessed 25 Feb 2019
6. International Chamber of Shipping: Annual-review-2017. <http://www.ics-shipping.org/docs/default-source/resources/annual-review-2017.pdf?sfvrsn=14> (2017). Accessed 25 Feb 2019
7. SAFETY4SEA: Global supply and demand for seafarers. <https://safety4sea.com/global-supply-demand-seafarers-2/> (2018). Accessed 25 Feb 2019
8. SAFETY4SEA: New report predicts potential shortage of almost 150,000 officers by 2025. <http://safety4sea.com/new-report-predicts-potential-shortage-of-almost-150000-officers-by-2025/> (2016). Accessed 25 Feb 2019
9. Yatsenko, M.S., Honcharova, I.O.: Aktualni problemy udoskonalennia yakosti kriuinovykh posluh (Actual problems of quality improvement of crewing services). *Economics: time realities*. 1(29), 162–170 (2017)
10. Pasyuk, E.D., Ivanova, S.E.: Teoreticheskiye aspekty razvitiya rynku uslug, predostavlyayemykh kryuingovymi kompaniyami (Theoretical aspects of the development of the market of services provided by crewing companies). <http://jurnal.org/articles/2007/ekon56.html> (2007). Accessed 25 Feb 2019
11. Lukashevich, V.M.: Opredeleniye sushchnosti kontseptualnykh podkhodov k vedeniyu kryuingovogo biznesa (Determination of the essence of conceptual approaches to the management of crewing business). *Technology audit and production reserves*. 5(2(19)), 43–47 (2014)
12. Ivashko, L.M., Bondarenko, Yu.M.: Optymizatsiia protsesu pidboru kadriv ekipazhiv suden (Optimization of the process of selection of frames of crews of vessels). Paper presented at the international conference on the socially-competent management of corporations in a behavioral economy, Lesya Ukrainka Eastern European National University, Lutsk, 4–9 November 2018
13. Ivashko, L., Zhuravlova, Y., Zhuravlova, T.: Optimizing the income of a crewing company in Ukraine. *SHS Web of Conferences*. 65, 04017 (2019). doi:10.1051/shsconf/20196504017

Matrix Models for Assessing the Taxation Subjects' Interaction Under Uncertainty of Socio-Economic Processes

Hanna Kucherova^[0000-0002-8635-6758], Olha Bilka^[0000-0002-0940-8294]

Classic Private University, 70B, Zhukovskoho Str., Zaporizhzhia, 69002, Ukraine
kucherovalhanna@gmail.com, lexeos11987@gmail.com

Liudmyla Serhieieva^[0000-0003-3207-0698]

Zaporizhzhia State Medical University, 26, Mayakovskoho Ave., Zaporizhzhia, 69000, Ukraine
sergeeva@optima.com.ua

Abstract. Topicality of research into interactions between tax environment subjects is justified by growing uncertainty of changes in socio-economic processes. The aim of this study is to assess interaction between taxpayers, controlling bodies and public authorities in view of dominant paradigms and results of expert and sociological research on subjects with regard to the degree of their influence on tax environment climate. Interaction is defined as a certain type of relations between subjects that result in developing mutual influence which induces corresponding changes of their states. Interaction is essentially a poorly structured category, which dictates a need to use soft modeling and subjective evaluation methods (matrix models). According to the degree of influence on tax environment climate, public authorities are proved to be the most influential subject, while taxpayers are found to be the least influential. Summative value of subjects' interaction is set as Very Good. It is determined by taxpayers' data as the best among other subjects. Based on the analysis of dynamics in parameters and activity of interaction subjects it is argued that in order to improve subjects' interaction productivity, it is appropriate to improve the mechanisms of subjects' interaction with public authorities of all others.

Keywords: assess, controlling bodies, interactions, influence, matrix models, public authorities, taxpayers.

1 Introduction

Research into interaction between different subjects of socio-economic system in regard to taxation is getting increasingly popular as current social and economic processes are highly dynamic and taxation mechanisms need to be adjusted to ensure timely and adequate response to changes. Ongoing crisis in Ukraine redoubles uncertainty in decision-making, therefore a vast majority of actors in the state socio-

economic system compensate for the lack of information with subjective perception of objective circumstances of taxation.

The period of reforms has added weight to the roles of those subjects of the socio-economic system that make tax decisions, including authorities, taxpayers, controlling bodies and communities whose tax relations are regulated by regulatory and legal provisions. Present gaps and shortcomings of these provisions in Ukraine have shifted the focus of the scope of research towards subjectivism, which is seen as a derivative of an individual subject's knowledge and experience. Therefore, validity of decision-making requires additional substantiation through expert judgment.

It should also be noted that so far Ukraine has carried out reforms of both taxation system structure and taxation mechanisms which determined the trends of redefining the aims and ways of interaction between taxation subjects. In order to adequately respond to structural and dynamic changes in the socio-economic system, we should regularly assess its subjects' interaction in respective tax environment and identify high-potential options of main trends development, which is actually the aim of this study. Objective assessment will allow us to substantiate or specify the areas which require further improvement of subjects' interaction in order to ensure long-term equitable relations and good balance of all actors' interests. The dynamics of these subjects' interaction values will determine the productivity of their relations.

Interaction is a means of studying subjects and their environment, certain activity and type of behavior, a mechanism of their organization under certain conditions – all in one. Types of relations between subjects in tax environment are determined by their socio-economic roles (a taxpayer or a representative of controlling bodies [12], structural and functional relations established by the system to enable actualization of both system properties and interaction subjects properties within the system. In the context of this research relation is determined by the way subjects' interaction in tax environment is organized, their state being mutually conditioned by each other and itself. Relations represent a broader concept than interaction and have a different nature. They can only emerge between subjects in tax environment on condition that states of subjects or the system are fixed, acceptably equilibrium and stable enough. In this context, legal and regulatory framework acts as a stabilizing factor, knowledge of laws and regulations has a positive effect on conscientious payment of taxes [13; 16; 17; 18]. Awareness, understanding, quality and simplicity of tax processes [1; 2; 5; 14], a positive attitude to taxation, and financial resilience [7; 8] predominantly (but not a hundred percent) ensure the required level of trustworthiness and timeliness of tax liabilities. In general, established relations between subjects in tax environment are realized within the framework of their interaction, which determines its effectiveness and productivity. In order to ensure objective assessment, functional and structural relations must be actualized, i. e. it is necessary to identify the set and structure of relations actual at period t .

Assessment of subjects' interaction in tax environment is generally based on analytical approaches and sociological research, a vast majority of which present their results in the form of a qualitative characterization of a selected set of parameters in certain areas of subjects' interaction. The above is explained by poor structuring of subjects interaction in tax environment due to informal factors of influence. For

example, a global monitoring of interaction between taxpayers and controlling bodies is being done by stakeholders in the context of Forum on Tax Administration (FTA) [21] based on the International Survey on Revenue Administration (ISORA). The data it presents give full and clear idea of the tax administration system in terms of services, favorable conditions, technological development, easing administrative pressure for all groups of taxpayers and controlling bodies.

McKinsey assess interaction between taxpayers and controlling bodies using their own practices. Results of their research [4] suggest that across the globe, tax authorities diverge in the maturity of their relations with taxpayers in the following main areas: scale of digitized interactions, scale of advanced analytics, process automation, and talent management. Leading scientists explain differences in subjects' interaction in tax environment from the standpoint of development determinants of specific tax systems and scientific paradigm evolution.

At the level of individual research groups, leading scientists empirically substantiate the need to expand the standard neoclassical paradigm of rational egoism by taking into account multivariuous behavioral strategies as a result of profound differentiation of taxpayers [2]. As a result of adopting a broader range of motivational factors of behavior, the paradigm of enforcement was updated and complemented with conceptual provisions of service trust models of interaction [1; 16; 17] and relation ethics [3]. In particular, this study [9] suggested ways of organizing interaction between public authorities and taxpaying individuals by means of transforming cooperation forms from antagonistic to service trust ones. The determinants of building synergetic subject interaction in tax environment are considered to be power of the government and trust in it [5]. However, productivity and effectiveness of interaction between controlling bodies and taxpayers also depends on their good will to cooperate which is a compromise between a decision as to compliance with tax legislation and personal attitudes, opinions and assessments in terms of taxation. [16; 17]. Another research [15] studies reflexive interaction with taxpayers, controlling bodies and public authorities and arrives at the conclusion that they are satisfactory due to shortcomings of taxation regulatory framework and controlling bodies operation.

Thus, subjects' interaction in tax environment is a poorly structured category and quantitative evaluation of its parameters is always characterized with fuzzy reliability and unified approaches. The aim of this research is to assess subjects' interaction in tax environment based on theories of dominant paradigms and multiple-criteria results of sociological and expert assessments of taxpayers, controlling bodies and public authorities with regard to the degree of their influence on tax environment climate.

2 Methods

Interaction is a certain type of relations between subjects that result in developing mutual influence which induces corresponding changes of their states. Subjects' mutual influence is formed in the course of two reciprocal processes. One arises as a result of subject's own activity and potency, the other is a result of response to this activity.

Combined, they form the dynamics of interrelation as a result of manifestation of dynamic change properties.

Forward call (process) from one subject to another is determined by the purpose of the interaction (C_p) and resources involved to achieve it ($R_c^p, ij = \langle C_p, R_c^p, t \rangle$); backward call is determined by the subject's reaction to the call which is formed depending on the congruence of interaction purposes ($C_p \equiv C_o$), availability and sufficiency of resources (R_c^o) presented in the format of possibilities and will to meet the purposes set: $ji = \langle C_{p=0}, R_c^o, t \rangle$, Fig. 1. There is also interaction of a subject with itself which is determined by self-organization processes (ii and jj).

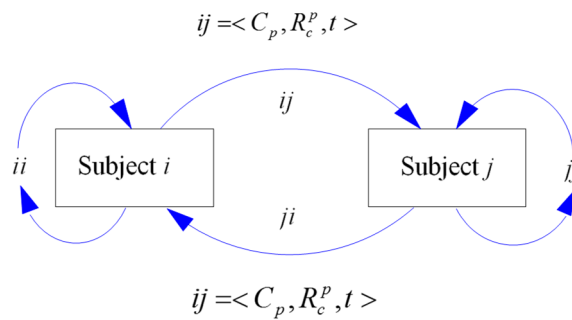

Fig. 1. The structure of interaction between i and j .

Thus, these forward and backward processes characterize the effectiveness of interaction between the subjects in a particular situation, which is determined by the change of subjects' state m as a result of their mutual influence ΔS_i^m .

Direct evaluation of the subjects' states in tax environment is made by expertise, based on objective and subjective tax consequences for all interaction parties.

In the study [15], subject interaction structure is formalized through a system of weight adjacency matrices $A_{ij} = ||v_{ij}||_{2 \times 2}$ where $v(I_i, I_j)$ is the forward relation weight and $v(I_j, I_i)$ is the backward relation weight. Adjacency matrix elements are determined by expertise in the absence of relevant statistical information and represent a set of subject interaction effectiveness values.

$$A_{ij} = ||v_{ij}||_{2 \times 2} = \begin{pmatrix} 0 & v(I_i, I_j) \\ v(I_j, I_i) & 0 \end{pmatrix}. \tag{1}$$

However, this approach does not take into account the difference in weights of interaction subjects which also depends on their socio-economic roles. For example, in tax environment authorities and controlling bodies are closer to each other than to taxpayers due to the fact that controlling bodies act as an executive authority while taxpayers are interaction subjects with their own purposes regarding income distribution, which are opposite to the authorities' ones, and also a source of forming state resources and social demand for public services. That is, the role of taxpayers in tax environment is multifaceted.

Thus, interaction subjects' roles determine how much they influence the process of tax environment formation. It is logical that the state and controlling bodies have more leverage in the process of managerial decision-making in tax environment while taxpayers can only respond and adjust their economic mechanisms to new tax realities. Taking into account the difference in subjects' influence on the process of tax environment formation (d_i), it seems appropriate to define the weight adjacency matrix of subjects' interaction more precisely:

$$A_{ij} = \left\| v^{d_{ij}} \right\|_{ij} \Big|_{2 \times 2} = \begin{pmatrix} 0 & v^{d_i}(I_i, I_j) \\ v^{d_j}(I_j, I_i) & 0 \end{pmatrix}. \quad (2)$$

Matrix eigenvalue λ characterizes the value of m -subjects' interaction and is determined in the following way:

$$\lambda(I_m) = \sqrt{v^{d_i}(I_i, I_j) \times v^{d_j}(I_j, I_i)}, \quad \lambda \in [0; 1]. \quad (3)$$

In order to estimate the influence on the process of tax environment formation (d_i), we designed a pairwise comparison matrix underlying analytic hierarchy process [20]:

$A = \|a_{ij}\|_{m \times m}$ and relative priority vector $(\bar{d}_1, \dots, \bar{d}_m)^T$ using the geometric mean formula where relative weight values for every row of matrix A are calculated as follows:

$$d_i = \frac{\sqrt[m]{a_{i1} \dots a_{im}}}{\sum_{i=1}^m \sqrt[m]{a_{i1} \dots a_{im}}}, \quad i = \overline{1, m}, \quad \text{where } m \text{ is the number of subjects which interact in tax}$$

environment.

Calculated adjacency matrix eigenvalues determine the proportion of subjects' influence on each other in tax environment while their batch forms a generalized adjacency matrix A^* . Generalized value of subjects' interaction can be determined as the root of the averaged sum of squares of the generalized adjacency matrix elements:

$$O_i = \sqrt{\frac{\sum_{i=1}^n a_i^2}{n}}, \quad O_i \in [0; 1]. \quad (4)$$

Further development of subjects' interaction in tax environment under invariable factors of influence can be forecast using an autonomous impulse process [19] when the state of interaction at a certain moment is calculated as follows:

$$p(t) = p(0) \times [A^t], \quad X(t) = X(0) + [A^0 + A + A^2 + \dots + A^t], \quad (5)$$

where $p(t)$ is the vector of changing values of subjects' interaction in the corresponding period of simulation, $p(0)$ is the vector of initial impulses, A is the adjacency matrix, t is simulation periods (t is 0, 1, 2, 3, ..., k) which represent the sequence of changes in the interaction state, $X(t)$ is the value of subjects' interaction in the t simulation period,

$X_{(0)}$ is the value of subjects' interaction in the initial simulation period, A is a unit matrix. As a result, we can build a set of forecasting scenarios of subjects' interaction development, $S=\{S_i\}$.

3 Materials

Key roles of subjects that determine the general climate in tax environment need clarifying. Despite generally accepted grouping of taxpayers into large, medium and small ones according to the size of their business, in Ukraine it is large and small economic entities that set trends for taxation due to their fiscal significance and vulnerability, respectively. The above can be explained by the fact that medium taxpayers' characteristics partially overlap with those of both small and large taxpayers, therefore, in the context of statistical significance, when grouped according to certain issues, they are most often grouped with small payers and occasionally with large ones. In addition, in the course of active reforms of Ukrainian taxation system, tax consciousness has significantly improved in terms of acquired knowledge [14]. At the same time, updated tax mechanisms are not free from legislative shortcomings and gaps, which informed taxpayers use to their advantage. Hence, if previously we used to single out the state and controlling bodies, currently the judicial branch is gaining momentum while usual importance is being given to legislative branch and controlling bodies which act as executive branch. The above can be explained by the fact that a large number of decisions made by controlling bodies are appealed in court. For example, according to the State Fiscal Service of Ukraine, in 2018 [11] 18.8 thousand law suits on taxation were heard in court (generally on the following: "...seeking revocation of tax decision-notice..., appeal of customs decisions") totaling 61.3 billion UAH [11]. The proportion of judgments in favor of controlling bodies is 62.5% which is 63.1% of the total value [11]. The rest of these cases, 37.5% with the share of 36.9% of the total sum, were ruled in favor of taxpayers [11]. Also, in 2018 there were 4.6 thousand cases appealing customs decisions totaling 3.2 billion UAH and 10.8% of the judgments are in favor of controlling bodies which amounts 5.87% of the total sum [11]. The structure presented confirms the fact that actions of controlling bodies are partially frivolous which results in a large proportion of their decisions being appealed. It accounts for the negative attitude of taxpayers to controlling bodies, lack of trust in the government and taxation in general, which drives their tax behavior to be more opportunistic.

In the context of this study we determine the elements of subjects' interaction adjacency matrix using the data of the TADAT Performance Assessment Report of the State Fiscal Service (SFS) [22] and data of the Annual Business Climate Assessment (ABCA) [6] regarding taxation, to which we apply the standard values of Harrington's desirability scale [10], namely very good: 1.00–0.80; good: 0.80–0.63; satisfactory: 0.63–0.37; bad: 0.37–0.20; very bad: 0.20–0. Then we conform the TADAT SFS Performance Assessment scale, where criteria were assessed according to the [A,B,C,D] scale from the best (A) to the worst (D) value, with Harrington's desirability scale in the following way: A–1; B–0.8; C–0.63; D–0.37. The resulting integrated

criteria values according to Harrington's desirability scale are presented in Table 1. Thus, in terms of tax administration the level of interaction between controlling bodies and taxpayers is 0.72. This value underlies the corresponding adjacency matrix of subjects' interaction. In order to assess the interaction between the authorities and controlling bodies from taxpayers' perspective, we analyzed the results of Annual Business Climate Assessment (ABCA) [6] regarding taxation and found the following:

- Taxpayers find the level of trust in government low, 50% of respondents see the government as an impediment to do business, 25% of respondents consider main government institutions to be essential obstacles for business development.
- About 50% of respondents among small business representatives believe that informal relations with authorities are key to their business success. Direct support by the government is believed to be ineffective for business development, priority is given to creating proper business climate.
- 35% of individual respondents and 38% of legal entities think that their business growth is impaired by high rates of taxes and fees, 22% of individuals and 29% of legal entities blame it on burdensome tax administration and accounting, 18% of individuals and 29% of legal entities refer to instability and frequent changes of economic legislation, 18% of individual respondents and 25% of legal entities mention regulatory pressure and other non-tax factors. Accordingly, with business growth and increasing size of enterprise tax conditions get significantly worse.

Table 1. Integrated values of criteria of subjects' interaction in Ukrainian tax environment*

Criteria	Actual TADAT value	Harrington's scale value	Geometric mean
Integrity of the Registered Taxpayer Base	C; C	0.63; 0.63	0.63
Effective Risk Management	C; D; C; C	0.63; 0.37; 0.63; 0.63	0.55
Supporting Voluntary Compliance	B; B; B	0.8; 0.8; 0.8	0.8
Accountability and Transparency	B; B; C; A	0.8; 0.8; 0.63; 1	0.8
Geometric mean for controlling bodies			0.67
Effective Tax Dispute Resolution	A; B; A	1; 0.8; 1	0.93
Efficient Revenue Management	B; C; C	0.8; 0.63; 0.63	0.68
Geometric mean for authorities			0.79
Timely Filing of Tax Declarations	B+; C	0.9; 0.63	0.75
Timely Payment of Taxes	A; A; A; B	1; 1; 1; 0.8	0.94
Accurate Reporting in Declarations	D+; B; D	0.47; 0.8; 0.37	0.52
Geometric mean for taxpayers			0.71
Geometric mean for all subjects			0.72

* Calculated based on the data [23]

Thus, government influence on taxpayers is characterized as negative, hindering business development, which corresponds to approximately 0.20 on Harrington's desirability scale. As far as controlling bodies are concerned, their value is only important for taxpayers in the context of informal relations and is estimated to be 0.37 on the scale. Taking into account that taxpayers have more trust in business

environment (other economic entities), improving business climate and, according to the SFS report (see Table 1), they timely file their tax declarations, pay taxes and fees, provide accurate and valid reports, we can calculate the value of their self-organization processes as a geometric mean of corresponding criteria, which equals 0.71. Then, bearing in mind market realities as to possible purpose inconsistency or lack of resources that interaction subjects may have, backward relation constitutes 0.63 on Harrington's scale.

4 Results

As a result, we have the following adjacency matrix of interaction between taxpayers P , with other subjects (public authorities D , controlling bodies K):

$$A_{PK} = \left\| v \left|_{PK} \right|_{2 \times 2} \right\| = \begin{pmatrix} 0 & 0.37 \\ 0.67 & 0 \end{pmatrix}, \lambda_{PK} = 0.50,$$

$$A_{PD} = \left\| v \left|_{PD} \right|_{2 \times 2} \right\| = \begin{pmatrix} 0 & 0.37 \\ 0.20 & 0 \end{pmatrix}, \lambda_{PD} = 0.27,$$

$$A_{PP} = \left\| v \left|_{PP} \right|_{2 \times 2} \right\| = \begin{pmatrix} 0 & 0.71 \\ 0.63 & 0 \end{pmatrix}, \lambda_{PP} = 0.67.$$

Different degree of interacting subjects' influence on tax environment should be considered. Subjects that interact in tax environment can be assessed according to their influence on tax environment using a pairwise comparison matrix, see Table 2.

Table 2. Subjects' pairwise comparison matrix according to their influence on tax environment formation, d_i .

Line numbers and names of compared subjects	Line numbers of compared subjects					Priority vector, \bar{d}_i	Weights, d_i
	1	2	3	4	5		
1. Legislative branch	1	2	4	6	8	3.29	0.46
2. Judicial branch	0.50	1	3	4	6	2.05	0.29
3. Controlling bodies	0.25	0.33	1	2	5	0.96	0.13
4. Large taxpayers	0.17	0.25	0.50	1	5	0.64	0.09
5. Small and medium taxpayers	0.13	0.17	0.20	0.20	1	0.24	0.03
Total						7.18	1

Thus, the value of interaction on the level of specific subjects should be adjusted by the degree of their influence on tax environment formation. Therefore, the elements of weight adjacency matrices are specified as follows:

$$A_{PK} = \left\| v^{d_{PK}} \left|_{PK} \right|_{2 \times 2} \right\| = \begin{pmatrix} 0 & 0.37^{0.09+0.03} \\ 0.67^{0.13} & 0 \end{pmatrix}, \lambda_{PK}^{d_{PK}} = 0.92,$$

$$A_{PD} = \left\| v^{d_{PD}} \right|_{PD} \Big|_{2 \times 2} = \begin{pmatrix} 0 & 0.37^{0.09+0.03} \\ 0.20^{0.46+0.29} & 0 \end{pmatrix}, \lambda_{PD}^{d_{PD}} = 0.52,$$

$$A_{PP} = \left\| v^{d_{PP}} \right|_{PP} \Big|_{2 \times 2} = \begin{pmatrix} 0 & 0.71^{0.09+0.03} \\ 0.63^{0.09+0.03} & 0 \end{pmatrix}, \lambda_{PP}^{d_{PP}} = 0.95.$$

Specifying the degree of influence according to the weights in Table 2, we determine the values of interaction on the level of large (*VP*) and small (*MP*) taxpayers, judiciary (*S*) and legislative institutions (*Z*).

$$A_{VP}^K = \left\| v_{VP}^K \right|_{2 \times 2} = \begin{pmatrix} 0 & 0.37^{0.09} \\ 0.67^{0.13} & 0 \end{pmatrix}, \lambda_{VP}^K = 0.93,$$

$$A_{PZ} = \left\| v_{VP}^Z \right|_{2 \times 2} = \begin{pmatrix} 0 & 0.37^{0.093} \\ 0.20^{0.46} & 0 \end{pmatrix}, \lambda_{VP}^Z = 0.66,$$

$$A_{PS} = \left\| v_{VP}^S \right|_{2 \times 2} = \begin{pmatrix} 0 & 0.37^{0.09} \\ 0.20^{0.29} & 0 \end{pmatrix}, \lambda_{VP}^S = 0.76,$$

$$A_{PP} = \left\| v_{VP}^{MP} \right|_{2 \times 2} = \begin{pmatrix} 0 & 0.71^{0.09} \\ 0.63^{0.09} & 0 \end{pmatrix}, \lambda_{VP}^{MP} = 0.96.$$

Similar calculations for controlling bodies arrive at the following results:

$$A_{PK} = \left\| v_{PK} \right|_{2 \times 2} = \begin{pmatrix} 0 & 0.67^{0.13} \\ 0.71^{0.09+0.03} & 0 \end{pmatrix}, \lambda_{PK} = 0.95,$$

$$A_{KD} = \left\| v_{KD} \right|_{2 \times 2} = \begin{pmatrix} 0 & 0.67^{0.13} \\ 0.79^{0.46+0.29} & 0 \end{pmatrix}, \lambda_{KD} = 0.89,$$

$$A_{KK} = \left\| v_{KK} \right|_{2 \times 2} = \begin{pmatrix} 0 & 0.67^{0.13} \\ 0.37^{0.13} & 0 \end{pmatrix}, \lambda_{KK} = 0.91.$$

As we can see, controlling bodies have the same influence on other subjects, as according to the SFS Report they function as executive authorities in terms of taxation, so the value of forward relation is 0.67 for all subjects. According to the SFS assessment, public authorities' value is 0.79. Self-organization processes in controlling bodies are determined as built in the way their functions duplicate, so it corresponds to 0.37 on Harrington's scale.

The results of subjects' interaction with public authorities are presented below:

$$A_{DP} = \left\| \mathbf{v} \right|_{DP} \Big|_{2 \times 2} = \begin{pmatrix} 0 & 0.68^{0.46+0.29} \\ 0.71^{0.09+0.03} & 0 \end{pmatrix}, \lambda_{PD} = 0.85,$$

$$A_{DK} = \left\| \mathbf{v} \right|_{DK} \Big|_{2 \times 2} = \begin{pmatrix} 0 & 0.93^{0.46+0.29} \\ 0.37^{0.13} & 0 \end{pmatrix}, \lambda_{DK} = 0.91,$$

$$A_{DD} = \left\| \mathbf{v} \right|_{DD} \Big|_{2 \times 2} = \begin{pmatrix} 0 & 0.68^{0.46+0.29} \\ 0.72^{0.46+0.29} & 0 \end{pmatrix}, \lambda_{DD} = 0.81.$$

The state interacts with taxpayers through the mechanisms of income formation, whose value is 0.68 according to the SFS Report criteria. Public authorities interact with controlling bodies in terms of taxation through effective tax dispute resolution using regulatory means. Its value is 0.93 according to the SFS Report criteria. Forward self-organization processes for public authorities in terms of taxation is evaluated according to the SFS Report criteria and equals 0.79, while backward processes are evaluated according to the criteria of all interaction subjects and equals 0.72.

Based on the received eigenvalues of adjacency matrices, a generalized matrix of interaction between public authorities, controlling bodies and taxpayers in tax environment can be designed:

$$A^* = \begin{pmatrix} 0.95 & 0.50 & 0.27 \\ 0.95 & 0.91 & 0.89 \\ 0.85 & 0.91 & 0.81 \end{pmatrix}.$$

Summative value of subjects' interaction in tax environment is, formula (4):

$$O_l = \sqrt{\frac{\sum_{i=1}^m a_i^2}{m}} = 0.81.$$

Based on the formula (5), we can study the dynamics of subjects' interaction activity and parameters of this interaction. The results are shown in Figures 2, 3.

As can be seen from Figure 2, the intensity of interaction for public authorities and controlling bodies is almost identical up to step 3, after which the activity of public authorities gradually slows down. On the one hand, it is due to their close functional and structural relations in taxation process. On the other hand, in the course of time a system needs more time for the procedure of managerial decision-making, which, in the context of the subjects' interaction, is reflected by delayed response, in our case on the part of public authorities. At the same time, the trends in the interaction of controlling bodies and taxpayers get closer in steps 1–3, and then controlling bodies' activity curve is more moderate, but it corresponds with taxpayers' one.

Based on the dynamics of parameters which describe subjects' interaction (Figure 3), we can see that the curves of public authorities and controlling bodies are close in steps 1–2. After that, public authorities' dynamics fall behind in tempo.

Taxpayers' interaction parameters are more dynamic as compared to other subjects' interaction. Thus, it can be argued that in order to improve the interaction results for all subjects in taxation environment, it is appropriate to revise and adjust the mechanisms of subjects' interaction with public authorities, whose parameter dynamics grows dissonant with other subjects' interaction trends in the course of time.

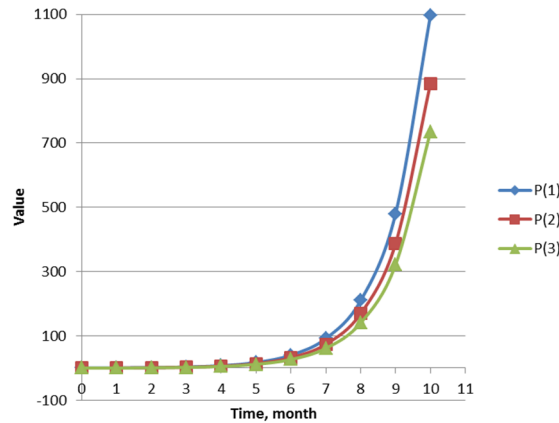

Fig. 2. Subjects' interaction activity dynamics.

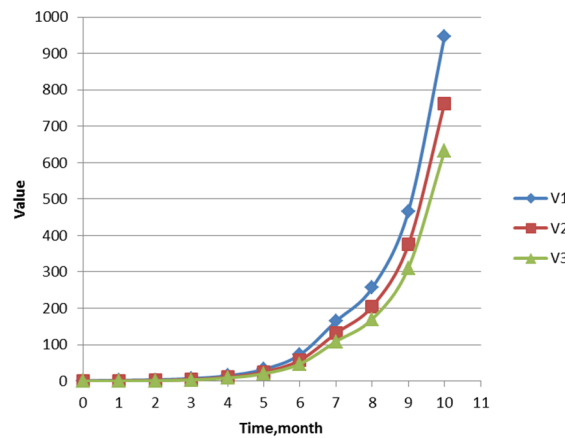

Fig. 3. Subjects' interaction parameters dynamics.

5 Conclusions

This research deals with assessment of interaction between taxpayers, controlling bodies and public authorities in view of dominant paradigms and results of expert and sociological research on the subjects with regard to the degree of their influence on tax environment climate. Interaction is defined as a certain type of relations between

subjects that result in developing mutual influence which induces corresponding changes of their states. Subjects' mutual influence is presented as two reciprocal processes: forward process arises as a result of subject's own activity and potency and is determined by interaction purpose and resources involved, backward process is a result of response to the activity, it is formed depending on the congruence of interaction purposes, availability and sufficiency of resources presented in the format of possibilities and will to meet the goals set. There is also interaction of a subject with itself which is determined by self-organization processes. Interaction is essentially a poorly structured category, which dictates a need to use soft modeling and subjective evaluation methods. The suggested approach is based on an adjacency matrix whose elements are eigenvalues of weight matrices of subjects' pairwise interaction. Matrix elements are determined by expertise. Based on the pairwise comparison matrix, subjects are differentiated according to the degree of their influence on tax environment climate. As a result, public authorities are found to be the most influential subject, while small and medium taxpayers are the least influential. Summative value of subjects' interaction is 0.81 which is determined by taxpayers' data as the best among other subjects. Dynamics of parameters and activity of interaction subjects have been studied by means of autonomous impulse process. It has been proved that in order to improve subjects' interaction productivity, it is appropriate to improve the mechanisms of subjects' interaction with public authorities of all others. The results of this research allow us to substantiate strategies aimed at improving and optimizing subjects' interaction in tax environment upon the criterion of maximizing effectiveness and productivity. In addition, significance of the issue justifies the need for a system of subjects' interaction monitoring for the sake of higher accuracy of tax result assessment. Future research will develop strategies to improve and monitor subjects' interaction in tax environment.

References

1. Abdul-Razak, A., Adafula, C.J.: Evaluating taxpayers' attitude and its influence on tax compliance decisions in Tamale, Ghana. *Journal of Accounting and Taxation*. **5**(3), 48–57 (2013). doi:10.5897/JAT2013.0120
2. Alm, J. Kirchler, E., Muehlbacher, S., Gangl, K., Hofmann, E., Kogler, C., Pollai, M.: Rethinking the research paradigms for analysing tax compliance behaviour. In CESifo forum. München: ifo Institut-Leibniz-Institut für Wirtschaftsforschung an der Universität München. 13.2, 33–40 https://www.researchgate.net/publication/254452677_Rethinking_the_Research_Paradigm_s_for_Analysing_Tax_Compliance_Behaviour (2012). Accessed 21 January 2019
3. Alm, J., Torgler, B.: Do ethics matter? Tax compliance and morality. *J Bus Ethics*. **101**, 1–17 (2012)
4. Barnay, A. Davis, J., Dimson, J., Gibbs, E., Korn, D.: Four innovations reshaping tax administration. McKinsey and company. <https://www.mckinsey.com/industries/public-sector/our-insights/four-innovations-reshaping-tax-administration> (2018). Accessed 21 January 2019
5. Batrancea, L.: Taxpayers And Tax Authorities Interacting Within The Mena Region: The Nexus Between Trust, Power And Compliance. *Annals of Faculty of Economics, University*

- of Oradea, Faculty of Economics. **1**(2), 241–250. <https://ideas.repec.org/a/ora/journal/v2y2014i2p241-250.html> (2014). Accessed 21 January 2019
6. Bepalko, V. Freik, N., Fedets, I., Kuziakiv, O.: Annual Business Climate Assessment, ABCA. USAID. http://www.ier.com.ua/en/sme_development/ABCA (2016). Accessed 8 January 2019
 7. Devos, K.: Factors influencing individual taxpayer compliance behaviour. Springer Science & Business Media. (2014). doi:10.1007/978-94-007-7476-6
 8. Fadzilah, E.N., Mustafa, R.M., Putri, N.K.: The Effect of Tax Understanding, Tax Payness Consciousness, Quality of Tax Service, and Tax Sanctions on Compulsory Tax of SMEs In Banyumas. *Acta Universitatis Danubius. Economica*. **13**(4), 28–38 (2017)
 9. Gangl, K., Hofmann, E., Kirchler, E.: Tax authorities' interaction with taxpayers: A conception of compliance in social dilemmas by power and trust. *New Ideas Psychol.* **37**, 13–23 (2015). doi:10.1016/j.newideapsych.2014.12.001
 10. Harrington, E.C.: The Desirability Function. *Industrial quality control*. **21**, 494–498 (1965)
 11. Information about appeals decisions Official portal State Fiscal Service of Ukraine. <http://sfs.gov.ua/diyalnist-/pokazniki-roboti/vregulyuvannya-podatkovih/informatsiya-schodo-oskarjen-rishen/> (2018). Accessed 21 January 2019
 12. Kim, J.S.: Analysis of the Tax Consciousness of a Taxpayer and a Tax Agent. *The Journal of the Korea Contents Association*. **8**(10), 142–150 (2008). doi:10.5392/JKCA.2008.8.10.142
 13. Kirchler, E., Niemirowski, A., Wearing, A.: Shared subjective views, intent to cooperate and tax compliance: Similarities between Australian taxpayers and tax officers. *Journal of Economic Psychology*. **27**(4), 502–517 (2006). doi:10.1016/j.joep.2006.01.005
 14. Kucherova, H.: Methods of Evaluating Taxpayers' Tax Consciousness. In: Nestorenko, O., Pokusa, O. (ed.) *Transformations in Contemporary Society: Economic Aspects*, pp. 243–250. Opole, The Academy of Management and Administration in Opole (2017) http://pedagogika.wszia.opole.pl/ebook/Monografia_2017_3.pdf Accessed 19 January 2019
 15. Kucherova, H.Y., Komazov, P.V.: Substantiation of tax consciousness model for subjects of taxation on the basis of reflexive interaction. *Central European journal for science and research*. **3**(16), 9–19 (2015)
 16. Muehlbacher, S., Kirchler, E., Schwarzenberger, H.: Voluntary versus Enforced Tax Compliance: Empirical Evidence for the “Slippery Slope” Framework. *European Journal of Law and Economics*. **32**, 89–97 (2011)
 17. Muehlbacher, S., Kogler C., Kirchler, E.: An Empirical Testing of the Slippery Slope Framework: The Role of Trust and Power in Explaining Tax Compliance, University of Vienna Working Paper. (2011). doi:10.1007/s10657-011-9236-9
 18. Pertiwi, D.N.: The Influence of Tax Consciousness, Service Tax Authorities and Tax Sanctions on Tax Compliance (Survey On Individual Taxpayer Conducting Business Operations and Professional Service in Jakarta). Dissertation, State Islamic University Syarif Hidayatullah Jakarta (2013)
 19. Roberts, F.S.: *Discrete Mathematical Models, with Applications to Social, Biological and Environmental Problems*. Prentice-Hall, Englewood Cliffs (1976)
 20. Saaty, T.L.: *The Analytic Hierarchy Process*. McGraw-Hill, New York (1980)
 21. *Tax Administration: Comparative Information on OECD and Other Advanced and Emerging Economies*. OECDiLibrary (2017). doi:10.1787/23077727
 22. Wolf, N.B., Khwaja, M., Andreasson, A., Fink, F.: Performance Assessment Report Ukraine Tax Administration Diagnostic Assessment Tool (TADAT). The World Bank. http://sfs.gov.ua/data/material/000/259/339853/Ukraine_TADAT_2018_Performance_Ass

essment_Report_Final_EN_6455958_v1_DMSDR1S.pdf (2018). Accessed 21 January 2019

23. Kucherova, H., Serhieieva, L., Bilska, O.: Assessment of tax subjects' interaction under uncertainty of socio-economic processes. *SHS Web of Conferences*. **65**, 01002 (2019). doi:10.1051/shsconf/20196501002

Modeling Company Sales Based on the Use of SWOT Analysis and Ishikawa Charts

Sergey Ivanov

Zaporizhzhya National University, 9, Engineer Preobrazhensky Ave., Zaporizhia, 69000,
Ukraine
flydaiver@gmail.com

Abstract. Marketing research at an enterprise is carried out by marketing units in order to determine a possible increase in the marketing activity of the enterprise. To identify the strengths and weaknesses of the sales management of the enterprise, the SWOT-analysis method was applied. A matrix of SWOT analysis of company's sales activity was built, which forms squares in the form of a combination of the following factors: "Strengths-Opportunities" (SO), "Strengths-Threats" (ST), "Weaknesses-Possibilities" (WO), "Weaknesses-Threats" (WT). The most significant intersections of the SWOT matrix factors of the analysis were analyzed, and it was proposed to use four types of strategies on their basis. To formalize cause-and-effect relations Ishikawa diagram was used.

Keywords: SWOT-analysis, Ishikawa charts, fuzzy cognitive map, strategies, model.

Today, SWOT analysis is one of the research types that allows identifying and structuring the strengths and weaknesses of an enterprise, which makes it possible to determine its potential capacity and possible dangers in marketing activities.

1 SWOT Analysis

The proposed method of conducting a SWOT analysis includes three stages.

At the first stage, the main factors are: Strengths, Weaknesses, Opportunities, Threats [1-3].

The strong sides of an enterprise (Strengths) include competitive environment (S1), availability of intercommodity substitution (S2) and market segmentation (S3).

The weak sides of an enterprise (Weaknesses) include product reliability (W1), product quality (W2), and service (repair) (W3).

The Opportunities determine favorable circumstances that an enterprise can use to gain the advantage, namely projected growth in sales through improving the quality of advertising work (O1), use of digital marketing methods (O2) and expanding the circle of regular customers (O3).

The Threats of economic entity may include decrease in sales of goods (T1), decrease in the efficiency of an enterprise (T2), and decrease in the production of goods (T3).

The exposed basic factors are tabulated in Table 1.

Table 1. SWOT-analysis of enterprise sale activity.

<i>Strong sides (S)</i>	<i>Weak sides (W)</i>
competitive environment (S1) intercommodity substitution (S2) market segmentation (S3)	product reliability (W1) product quality (W2) service (repair) (W3)
<i>Opportunities (O)</i>	<i>Threats (T)</i>
improving the quality of advertising work (O1) use of digital marketing methods (O2) expanding the circle of regular customers (O3)	decrease in sales of goods (T1) decrease in the efficiency of an enterprise (T2) decrease in the production of goods (T3)

It should be noted that possibilities from the point of SWOT-analysis are not all those that exist, but only ones, which can be used by an enterprise.

At the second stage, the matrix of sale activity SWOT-analysis of an enterprise is built (Table 2). The most essential intercrossings of factors which are marked 1 and 0 in case of absence of intercrossings are pointed out in the matrix (graph adjacency matrix). The received matrix allows to show graphically intercrossing factors and to cut off unimportant ones and to build a graph.

Table 2. Matrix of SWOT-analysis of an economic object employees.

		O			T		
		O1	O2	O3	T1	T2	T3
S	S1	1	1	0	1	0	0
	S2	0	1	1	0	0	0
	S3	1	0	0	1	0	0
W	W1	0	1	1	1	1	1
	W2	0	0	0	1	0	0
	W3	0	0	0	1	0	0

The built matrix forms the squares as a combination of the following factors: “Strengths-Opportunities” (S-O), “Strengths-Threats” (S-T), “Weaknesses-Opportunities” (W-O), “Weaknesses-Threats” (W-T).

At the third stage, the most substantial intercrossings of factors are analysed.

Thus in the square “Strengths-Opportunities” (S-O) intercrossings of the following factors are important:

S1O1 – improvement of the competitive environment will allow to increase enterprise’s sale activity by improving the quality of advertising;

S1O2 – improvement of competitive environment will allow to promote sale activity of an enterprise by applying methods of digital marketing, namely expansion of the target market;

S2O2 – intercommodity substitution availability causes the necessity of applying methods of digital marketing, that will result in the expansion of the target market and increase enterprise's sale activity;

S2O3 – intercommodity substitution availability requires from the enterprise additional expenses connected with the expansion of the circle of regular purchasers, which in return is directed at increase of the enterprise's sale activity;

S3O1 – market segmentation is considered as a process of finding optimum segments of market with the purpose of locating goods on the segments taking into account the quality of advertising, which is in its turn directed at the increase of the enterprise's sale activity.

In the square “Strengths-Threats” (S-T) intercrossings of the following factors are important:

S1T1 – underestimation of the competitive environment within the framework of the enterprise can result in decline of commodity sale;

S3T1 – breaking up of potential users at the market into different groups without considering their interests results in decline of commodity sale.

In the square “Weaknesses-Opportunities” (W-O) intercrossings of the following factors are important:

W1O2 – increase of the commodity reliability allows to extend the target market by the application of the digital marketing methods;

W1O3 – increase of the commodity reliability allows to extend the circle of regular users.

In the square “Weaknesses-Threats” (W-T) intercrossings of the followings factors are important:

W1T1 – the commodity reliability decline reduces the enterprise sale activity;

W1T2 – the commodity low reliability reduces the efficiency of the enterprise;

W1T3 – the commodity low reliability results in decline of producing goods;

W2T1 – the decline of the commodity quality may cause the decline of the commodity sale;

W3T1 – the increase of expenses on service (repair) may result in the commodity sale decline, which will reduce efficiency of the enterprise in return.

On the basis of the conducted analysis of SWOT-matrix squares it is possible to offer the strategy of four types [4]:

- strategies of SO type are strategies of development, which take into account the following: improvement of competitive environment, intercommodity substitution availability causes the necessity of applying methods of the digital marketing with the account of the expansion of the circle of regular purchasers and finding optimum segments of market with the purpose of locating goods at them;
- strategies of type ST are to minimize the underestimation of competitive environment taking into account breaking up regular purchasers at the market;
- strategies of type WO are a weak side management, i.e. the increase of the commodity reliability, that will allow to extend the target market by applying methods of the digital marketing and the circle of regular purchasers;

- strategies of type WT are limitations, which take into account the commodity reliability, quality and additional expenses, that can reduce sale activity and efficiency of the enterprise.

Highlighting basic interdependent is groups especially important for the development of marketing strategy.

2 The Ishikawa Charts

To formalize cause-and-effect relations the Ishikawa charts is applied [5, 6]. The diagram of cause-and-effect relations is presented in Fig. 1.

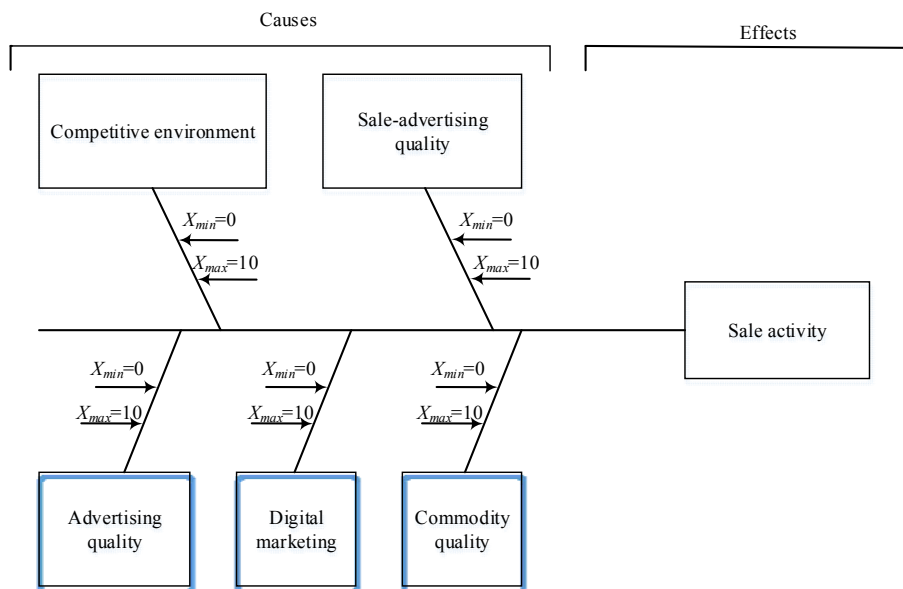

Fig. 1. Diagram of cause-and-effect relation.

In this diagram sale activity of an enterprise, which influences the efficiency of work is divided by its character into 5 basic groups: competitive environment, market segmentation, advertising quality, digital marketing and quality of commodity. Each factor is presented by a proper fuzzy variable with the range of definition X and by term-set.

Input term-set corresponds to linguistic variables describing marketing characteristics, while sale activity of the enterprise is the output term-set. Each of the set can be presented as $T_i^j = \langle x, \mu_{T_i^j}(x) \mid x \in [x_{min}, x_{max}] \rangle$, where $i = \overline{1, n}$; $j = \overline{1, m}$; n – is the amount of term-sets, characterizing a certain variable.

The management sale activity of the enterprise is carried out on the basis of the expansion of the target market, related to the factors (by linguistic variables) of

competitive environment (T1), market segmentation (T2), advertising quality (T3), digital marketing (T4), quality of commodity (T5) and sale activity (T6).

3 Fuzzy Cognitive Map

In this case, the problem of managing sale activity is related to the large ambiguity of influence factors. Therefore enterprise sale resource planning is based on introducing the system as a fuzzy cognitive map [7].

Unlike the traditional cognitive modeling the fuzzy cognitive maps (FCM) are fuzzy oriented graphs [8-10] the nodes of which correspond to fuzzy sets. Therefore the model of FCM is the oriented graph which reflects not only cause-and-effect relation between conceptual objects but also determines the degree of influence of connected concepts.

The fuzzy cognitive map is a graph $G=(T, W)$, where vertex set $T=\{T_i\}$, and $W=\{w(u_i, v_j)\}$ is a set of connections between them. Each vertex is assigned to a concept, characterized by a term-set of linguistic variables, determined by the data tuple.

Establishing connections between input (T_1, \dots, T_5) and output (T_6) vertex allows to build the fuzzy cognitive map of the enterprise management sale activity process as the oriented graph on the basis of adjacency matrix (Table 2), presented in Fig. 2.

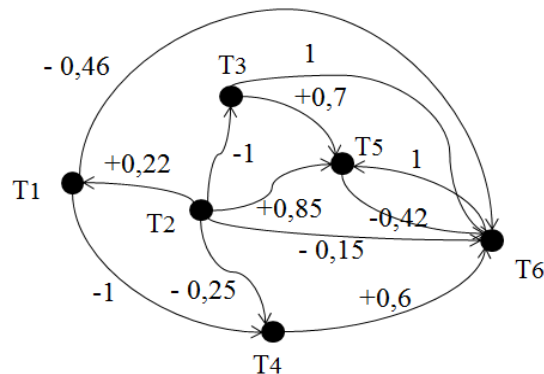

Fig. 2. Model of oriented graph.

However the model of FCM as oriented graph (Fig. 2) suggests that all influences of factors (vertices) on each other are on the interval $[0; 1]$. Therefore this model can be presented as a structural model of the enterprise management sale activity process.

A more accurate model can be developed by giving the oriented graph arcs numeric values (weight), that will allow to get a weighted oriented graph. The given weight of arcs can be interpreted as action force of factor, and the sign can be either positive (increase of influence) or negative (diminishing of influence).

The weights of arcs of a weighted oriented graph are determined on the basis of the experts' conclusions on the general laws of the marketing management process (Table 3).

Table 3. Weights of curve of a scales oriented graph.

curve	weight	Conclusions on the choice of scales
(T ₁ , T ₆)	-0.46	With the increasing influence of the competitive environment, according to expert data, the magnitude of the impact is -0.46.
(T ₂ , T ₁)	+0.22	With the use of tools, market segmentation, according to expert data, the magnitude of the impact is +0.22.
(T ₂ , T ₃)	-1	With the involvement of tools market segmentation, the quality of advertising work is changed to -1.
(T ₁ , T ₄)	-1	Increasing the influence of the competitive environment allows us to establish a unit value of the weight of this arc.
(T ₂ , T ₄)	-0.25	Increasing investment in market segmentation tools leads to a decrease in the quality of digital marketing, according to expert data, the arc size will be -0.25.
(T ₂ , T ₅)	+0.85	With an increase in market segmentation, the quality of goods grows, according to expert data, the weight of this arc will be +0.85
(T ₂ , T ₆)	-0.15	An increase in market segmentation leads to a decrease in sales activity. According to expert data, the weight of the arc is -0.15.
(T ₃ , T ₅)	+0.7	The increase in the quality of the goods due to the increase in the quality of advertising work. According to expert data, the arc weight will be +0.7.
(T ₃ , T ₆)	+1	The increase in the quality of advertising work, causes an increase in sales activities.
(T ₄ , T ₆)	+0.6	As digital marketing grows, so does sales. According to expert data, the arc weight will be +0.6.
(T ₅ , T ₆)	-0.42	According to experts, the weight of the arc will be about -0.42.
(T ₆ , T ₅)	+1	According to experts, the weight of the arc will be about 1

Figure 2 shows a model of a weighted oriented graph constructed by transforming a model of a fuzzy cognitive map into a oriented graph with negative edge weights.

To analyze a model that has the form of a weighted oriented graph (Fig. 2), assumptions are made about the effect of changing the value of a parameter of one vertex on the parameters of other vertices.

These assumptions are called rules for changing the values of the parameters of the vertices. The choice of these rules is a fundamental step in the simulation of an autonomous pulse process, where it is necessary to monitor the spread of initial pulses in the system.

Let the initial values of the parameters at each vertex T_1, T_2, \dots, T_6 , of the digraph shown in Fig. 2 are equal 0.

Each vertex is assumed T_i at discrete times $t = 0, 1, 2, 3, \dots$ takes value $v_i(t)$.

Derived value $v_i(t+1)$ determined by information about increasing or decreasing its values of the vertices adjacent to the vertex T_i at time t .

Change $p_i(t)$, called impulse, given by the difference in weights in the i -th vertex: $v_i(t) - v_i(t-1)$, at $t > 0$.

Changes in the values of the sales process of the enterprise in a weighted oriented graph, has the following form:

$$v_j(t+1) = v_j(t) + \sum_{i=1}^n w(u_i, v_j) p_i(t), \quad (1)$$

where $v_j(t)$ – vertex weight j at time t , $w(u_i, v_j)$ – arc weight of u_i to v_j at time t .

Since the pulse in j -th vertex: $v_j(t+1)-v_j(t)=p_j(t)$, then from the expression (1) the value of the pulse can be written in the following form:

$$p_j(t) = \sum_{i=1}^n w(u_i, v_j) p_i(t). \quad (2)$$

In the digraph in Fig. 2 we study the dynamics of five simple impulse processes, each of which begins independently of the other at the vertex T_1, T_2, \dots, T_5 corresponding to the sales factor.

Then the matrix of weights of NKK will have the following form Table 4.

Table 4. FCM weights matrix.

	T_1	T_2	T_3	T_4	T_5	T_6
T_1	0.00	0.00	0.00	-1	0.00	-0.46
T_2	0.22	0.00	-1	-0.25	0.85	-0.15
T_3	0.00	0.00	0.00	0.00	0.7	1
T_4	0.00	0.00	0.00	0.00	0.00	0.6
T_5	0.00	0.00	0.00	0.00	0.00	-0.42
T_6	0.0	0.00	0.00	0.00	1.00	0.00

Thus, we have five vectors of initial impulses:

$$p_1(0)=(1 \ 0 \ 0 \ 0 \ 0 \ 0),$$

$$p_2(0)=(0 \ 1 \ 0 \ 0 \ 0 \ 0),$$

$$p_3(0)=(0 \ 0 \ 1 \ 0 \ 0 \ 0),$$

$$p_4(0)=(0 \ 0 \ 0 \ 1 \ 0 \ 0),$$

$$p_5(0)=(0 \ 0 \ 0 \ 0 \ 1 \ 0).$$

Vertex T_6 , indicating the level of marketing activities of the enterprise, is targeted at each stage of this process. The results of calculations of the dynamics of the pulse at the vertex T_6 at different initial vertices of simple impulse processes are presented in Table 5.

Table 5. Dynamics pulse at the vertex T_6 at different initial impulses.

t	$p_1(t)$	$p_2(t)$	$p_3(t)$	$p_4(t)$	$p_5(t)$
0	0	0	0	0	0
1	-0.4600	-0.15	1	0.6	-0.42
2	-0.6000	-1.608	-0.294	0	0
3	0.1932	0.225	-0.42	-0.252	0.1764
4	0.252	0.6754	0.1235	0	0
5	-0.08114	-0.095	0.1764	0.1058	-0.074

Here $p_i(t)$ denotes the value of the pulse at the vertex T_6 at the moment t of the action of a simple impulse process with the beginning at the i -th vertex.

Graph simulation of the dynamics of the pulse at the top T_6 with the corresponding impulse effect is presented in Fig. 3.

Thus, as a result of modeling the sales activity of an enterprise with a pulse effect on a weighted oriented graph (Fig. 3) and modeling the dynamics of weight, it has been established (Fig. 4) that improving the quality of advertising work (vertex T_3) and applying digital marketing (vertex T_4) lead to higher levels of marketing activities of the enterprise.

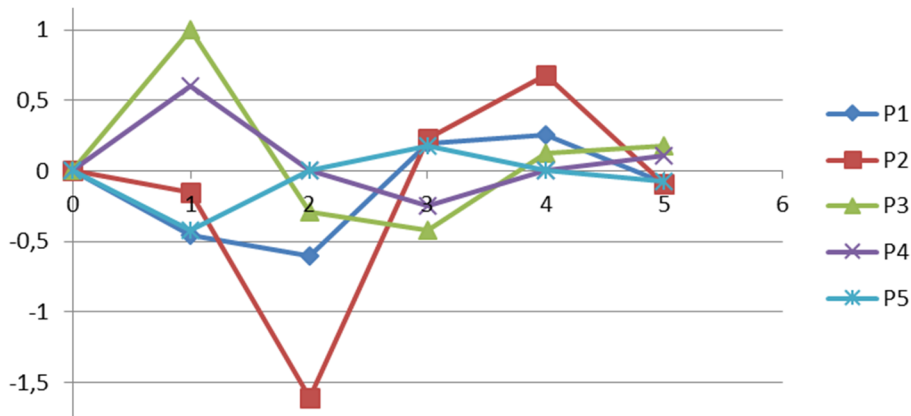

Fig. 3. Modeling the sales activity of an enterprise with a pulse effect on a weighted oriented graph.

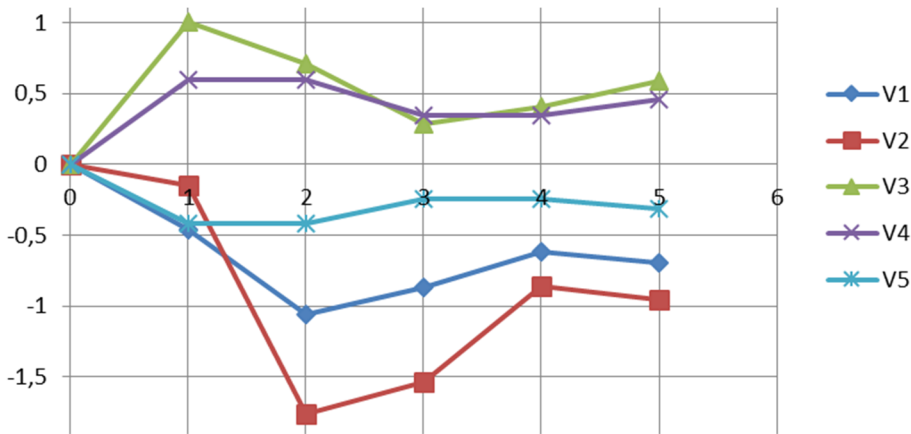

Fig. 4. Modeling the assessment of the marketing activity of the enterprise (vertex T_6) with a pulse effect on a weighted oriented graph.

The results of calculations of the dynamics of weight at the vertex T_6 at different initial pulses are presented in Table 6 where $v_i(t)$ denotes the weight value of the vertex T_6 at

the moment t of the action of a simple impulse process with the beginning at the i -th vertex.

Table 6. The results of calculations of the weight of the vertex T_6 with different initial impulses.

t	$v_1(t)$	$v_2(t)$	$v_3(t)$	$v_4(t)$	$v_5(t)$
0	0	0	0	0	0
1	-0.4600	-0.15	1	0.6	-0.42
2	-1.0600	-1.758	0.706	0.6	-0.42
3	-0.8668	-1.533	0.286	0.348	-0.244
4	-0.6148	-0.858	0.4095	0.348	-0.244
5	-0.69594	-0.952	0.5859	0.4538	-0.318

Graph modeling of the dynamics of weight at the vertex T_6 with a pulse effect is presented in Fig. 4.

The corresponding lines in Fig. 4 have an increasing trend in the observed time interval. Perturbations at the vertices: T_1 – “competitive environment”, T_5 – “quality of commodity”, T_2 – “market segmentation” lead to weight changes at the vertex T_6 .

This means that when building strategies for managing the marketing activities of an enterprise, attention should be paid to the competitive environment, product quality and market segmentation.

4 Conclusions

Thus, the model of intercrossings of strong and weak sides was built on the basis of SWOT-analysis; it is suggested to use effective strategies for the corresponding intercrossings on the basis of the model. Recommendation for the use of strategies of four types for development of company marketing were developed. The Ishikawa charts reflecting cause-and-effect relation of sale activity of enterprise is built.

On the basis of the received data it is possible to build the model of fuzzy cognitive map, that can result in determining how the modification of factors will influence the sale under different initial conditions and it is possible to analyse interrelation of advertising quality, application of the digital marketing with the change of the enterprise sale activity level.

References

1. Churkina, V., Suhova, O.V.: *Primenenie metoda SWOT analiza v issledovanii sistemyi upravleniya organizatsii. Obschestvo i tsivilizatsiya: Tendentsii i perspektivy razvitiya sovremennogo obschestva v XXI veke*, Voronezh (2016)
2. Mikuláš, L.: *Mathematical Optimization and Economic Analysis*. Springer, Vienna (2009)
3. Shipilov, N.Yu., Koneva, A.I.: *Provedenie SWOT-analiza v nekommercheskoy organizatsii. Tavricheskiy obozrevatel*, Yalta (2017)
4. Ansoff, H.I.: *Strategic Management*. Springer, New York (2007)

5. Samartseva, A.V., Belyakova, E.V.: Ispolzovanie diagrammy Isikavyi v tselyah formirovaniya gorodskoy logisticheskoy infrastrukturyi. Aktualnyie problemy aviatsii i kosmonavtiki, Krasnoyarsk (2013)
6. Logunova, O.E.: Primenenie prichinno-sledstvennoy diagrammy Isikavyi v reputatsionnom menedzhmente. Nauchnyie issledovaniya, Ivanovo (2015)
7. Paklin, N.B.: Nechetko-kognitivnyiy podhod k upravleniyu dinamicheskimi sistemami. Iskustvennyiy intellekt, Donetsk (2003)
8. Volkov, V.Yu., Volkova, V.V.: Nechetkaya kognitivnaya karta kak model slozhnoy sistemy upravleniya. Izvestiya TulGu. Tehnicheskie nauki, Tula (2017)
9. Ivanovich, V.V., Savina, I.A., Sharipova, I.I.: Postroenie nechetkih kognitivnyih kart dlya analiza i upravleniya informatsionnyimi riskami vuza. Vestnik Ufimskogo gosudarstvennogo aviatsionnogo tehnikeskogo universiteta, Ufa (2008)
10. Evstafev, G.A.: Nechyotkie kognitivnyie kartyi primenitelno k upravleniyu riskami informatsionnoy bezopasnosti. Izvestiya Yuzhnogo federalnogo universiteta. Tehnicheskie nauki, Taganrog (2009)
11. Ivanov, S.: Company's sales simulation based on the use of SWOT analysis and Ishikawa charts. SHS Web of Conferences. **65**, 04018 (2019). doi:10.1051/shsconf/20196504018

Cloud-based Digital Marketing

Mykola Ivanov

Zaporizhzhya National University, 7, Engineer Preobrazhensky ave., Zaporizhia, 69000,
Ukraine
nn_iva@ukr.net

Abstract. In the article, the author provides an analysis of the state of the digital economy, when the dynamics of processes in the economy are quite high and a quick analysis of multidimensional data is required, where the strategy for the production of goods and market promotion, as well as pricing, depends on consumers. The author determined that the activity of modern trading platforms is aimed at the formation of the product range and its product range with the most advantageous characteristics of the product. These requirements have a direct impact on marketing strategy and pricing at the Internet-market. The author proposed the concept of building a digital marketing system based on the theory and practice of market segmentation, which takes into account many factors: geographical, costs, time, and others. The formation of similarities in consumption and pricing in the Internet market is the unifying factor in marketing research. In this concept, the author applied the method of assessing consumer efficiency, which is based on the use of rating estimates obtained on the basis of the ranking of expert opinion. Thus, the proposed concept and method for assessing consumer demand in the target market is aimed at the perspective management of trading platforms using cloud technologies.

Keywords: digital economy, digital marketing systems, Internet-market, cloud technologies.

The digital economy opens up new directions, among which digital marketing occupies has one of the leading places.

Bill Gates in his book “Business at the speed of thought” in 1999 expressed the idea of how technology can help improve business and how it will change the nature of the company in the future. Bill Gates emphasized that “If a company is not on the Internet, then the company does not exist at all.”

K. Smith [1] ten years later suggested that by 2010 the number of Internet users in the world will exceed 2 billion. And as a consequence of the rapid development of the Internet will increase the use of digital marketing that is considered as a strategic objective of any company.

J. Armitage [2] confirmed in 2015 that the digital strategy should be the main focus of any company's market strategy. J. Armitage also expressed the idea that fast developing technology will lead to new forms of business.

M. Gaikwad [3] in 2016 examined modern marketing and found that the digital marketing deserves special attention for companies.

D. Longo [4] in 2016 put forward the hypothesis that the strategy in the digital marketing should be a priority, and this is an additional way of doing business in the company.

S. Kingsnorth [5] in the course of his research in 2017 suggested the idea that digital marketing is widespread and is actual direction.

Significant contribution to theoretical and practical developments, as well as the formation of scientific fields of marketing research, sales marketing functions, business process management, information system models, optimization models for prices and sales volumes in consumer markets, marketing management functions and approaches, problem-oriented business management processes, modeling of cooperative relations in the digital economy have made works of: V. Halitsyn [6], Philip Kotler [7], V. Kravchenko [8], V. Lukyanchenko [9], Yu. Lysenko [10, 11], I. Rezhnikova [12] and S. Ivanov [13] and others.

In modern conditions, when the dynamics of economic processes is quite high, real-time data required, where commodity production strategy, marketing promotion and pricing depend on the consumers, the more urgent task is to build digital marketing system with the use of cloud technologies.

All the activities of modern trading platforms are aimed at the formation of the product range and with the most advantageous characteristics, which are aimed at meeting the needs of the consumer. These requirements have a direct impact on marketing strategy and pricing in the Internet-market. Therefore, digital marketing has a direct connection with the customer, where the information from consumers received in real time can quickly respond to the rapidly changing demands.

The digital marketing systems allow to identify the demand and meet the needs of each individual customer. Therefore, digital marketing has become the main way to communicate with consumers in the Internet market.

The aim of the work is to develop marketing research techniques, methods of processing and analyzing information using cloud technologies in the digital economy.

It is proposed to construct the concept of marketing research based on the theory and practice of market segmentation, which takes into account the multidimensionality of factors: geographical, costs, time, and others.

The unifying factor in the marketing research is to develop similarities in consumption and pricing of Internet-market. These analogy are associated with the principles of similarity [7], which make products similar and form substitute products. This fully applies to goods and services, which can be considered as a target market.

Such a target market corresponds to the properties of the Internet, which is not limited to the contingent of consumers of goods, services and information resources.

The products and the services sold on the market, have a number of specific economic and social characteristics. Firstly, they have lower prices. [14] Secondly, the range of products is not restricted, only limited by the specificity of the trading platform. The digital marketing puts forward a number of requirements for the target market, which were analyzed from the position of the possibility of their implementation on trading floors (Table 1).

The choice of the target market is carried out on the basis of the task of increasing sales. In this case, digital marketing is used, which is a multi-dimensional structure.

This is due to the fact that producers and consumers are combined on the trading platform in the global Internet.

Table 1. Target market requirements for segmentation.

<i>The target market requirements</i>	<i>The restrictions</i>
The profitability	The profitability level is limited
The volume of sales	The volume of sales is limited
The presence of competitors	The presence of competitors is limited
The availability of substitute products	The volume of substitutes present in the target market is limited
The lack of a “strong” position of consumers	The consumers are closely related
The estimation of the demand and satisfaction of the customer’s needs	The technological capabilities of trading platforms

Therefore, the concept of building a digital marketing system using cloud technologies (Fig. 1) includes not only a study of the target product market, but also a solution to the analytical function of marketing (analysis, evaluation, forecasting).

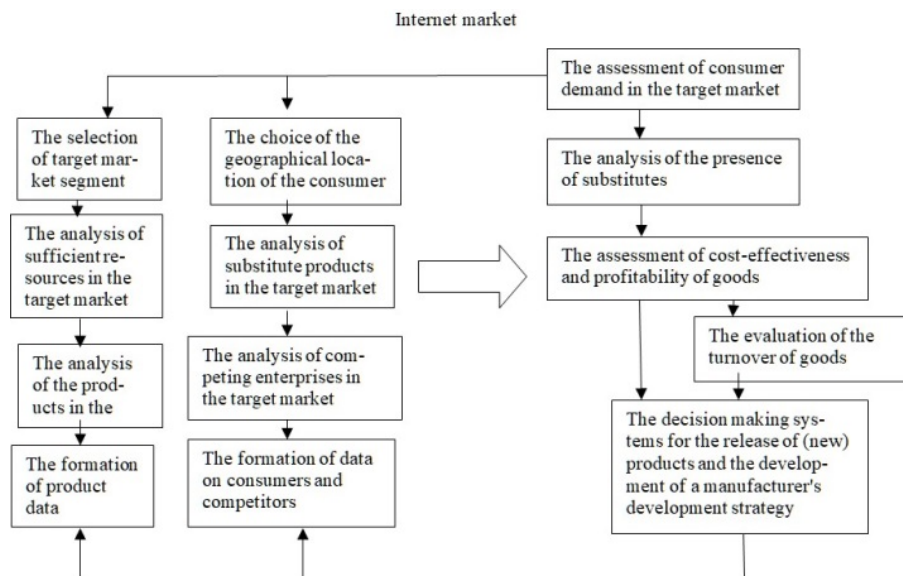

Fig. 1. The concept of building a digital marketing system using cloud technologies.

In this concept, a method of assessing consumer efficiency is used, which is based on the use of rating estimates derived from the ranking of expert opinion on several scales of the order. Experts can be both consumers and manufacturers. The application of expert assessments is necessary in conditions with the Internet market. The method for assessing consumer demand in the target market is presented in Fig. 2.

The implementation of the method begins with the formation of the initial data. Further, each product is assigned an expert assessment (P_i) on the following five-point

scale: 5 – very high utility; 4 – high utility; 3 – average utility; 2 – low utility; 1 – very low utility.

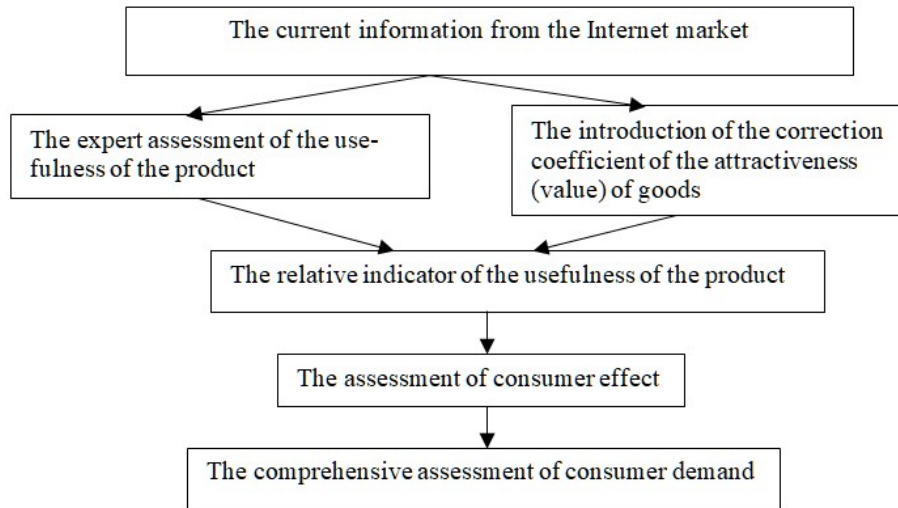

Fig. 2. The method of assessing consumer demand in the target market.

Additionally, to take into account prices and costs, a utility cost correction factor is used (k_i), with the following values: 1.5 – the consumer is ready to pay extra for utility; 1.2 – the consumer is interested in utility, but will be interested in price; 1.0 – consumer will not pay for utility.

Absolute rating indicators of the usefulness of the product are uninformative and poorly comparable for different products, therefore, the relative indicator (utility index) is used further and is calculated by the following expression:

$$x_i = \frac{P_i \cdot k_i}{\sum_{i=1}^n P_i \cdot k_i} \quad (1)$$

where P_i – rating score i utility (1...5, entire);

k_i – coefficient, cost-based utility;

n – amount of product utility;

$i = 1 \dots n$.

The formation of utility indices is the next step in measuring the consumer effect of individual market segments. For the product under consideration, the following consumer benefits are highlighted: product quality, delivery time, price policy, form of payment.

The proposed list of benefits can be expanded and specified.

The next step in the implementation of the method is to form columns of the matrix, which form innovations – both that are in the arsenal and anticipated: organizational, technical, service, etc. This list may include innovations, described qualitatively, and innovations expressed by the values of technical and economic indicators.

In principle, this method can be used to synthesize innovations. In this case, the activity of the trading platform is based on the principle “what can be done (change, improve, supplement, etc.) to form a specific utility”.

The elements of the matrix of size $n \times m$, where m is the number of innovations considered, are filled with rating estimates of the strength of influence of the j innovation on the i product benefit. The influence rating is set on the following ten-point scale of order: 9 – strong influence; 3 – average impact; 1 – weak influence; 0 – innovation does not affect the individual benefits of the product. The formation of utility indices of commodity products is given in table 2.

Table 2. The formation of utility indexes for evaluation consumer benefits.

The consumer benefits	P_i	k_i	$P_i k_i$	x_i
1. The product quality	5	1.5	7.5	0.36
2. The delivery time	3	1.3	3.9	0.19
3. The price policy	4	1.3	5.2	0.25
4. The form of payment	4	1.0	4.0	0.2
	S	$\sum_{i=1}^n P_i k_i = 20.6$	$\sum x_i = 1$	

Using the designation y_{ji} to assess the strength of the effect of the j product on the i benefit, we can calculate the conditional and unconditional indices of the consumer effect of each product. Then we write the conditional index as follows:

$$E_{ji} = \frac{\sum_{i=1}^n x_i y_{ji}}{\sum_{j=1}^m \sum_{i=1}^n x_i y_{ji}}. \quad (2)$$

Conditional index is useful for comparative assessment of the product according to the degree of its influence on its total value.

However, the conditional index depends on the total volume of the product and shows the relative contribution of a single product to the formation of benefits and therefore cannot be used to quantify the consumer effect.

To measure a consumer effect that does not depend on the total amount, an unconditional consumer effect index is used. When constructing it as a base we use the value of the consumer effect, which have the maximum effect on the utility of each consumer. Then, according to expression (2), the unconditional index can be written in the following form:

$$B_{ji} = \frac{\sum_{i=1}^n x_i y_{ji}}{\sum_{i=1}^n x_i y_{jimax}}. \quad (3)$$

Considering that in the given dependence $y_{jimax} = 9$ (according to the adopted scale), the expression in the denominator also takes the value equal to 9, i.e. = 9, and the evaluation of the consumer effect of the j -th product is relative to the absolute value. The obtained data will allow the decision support management system to choose a perspective direction for the production of goods. For the considered goods in the table 3 the list of main indicators was used, a matrix was formed and conditional and unconditional indices of consumer effect were determined according to the dependencies.

The results of calculations (Table 3) show steady demand (logistic system 0.82, demand 0.86) of the trading floor (Rozetka.com.ua).

Table 3. The formation of conditional and unconditional indices of consumer effect for a trading platform (Rozetka.com.ua).

The consumer benefits	x_i	The volume of goods	The demand	The range of trading platform	The logistics system	Dealer Relations
1. The product quality	0.36	8	9	9	7	5
2. The delivery time	0.19	7	6	9	8	7
3. The price policy	0.25	7	8	-	7	4
4. The form of payment	0.2	5	7	-	8	9
	1.0	6.96	7.78	4.95	7.39	5.93
	E_{ji}	0.21	0.24	0.15	0.22	0.18
	B_{ji}	0.77	0.86	0.55	0.82	0.66

In the future, the Internet can be effectively used for various marketing research of the Internet market. The global network provides an opportunity to conduct market research based on the current data of the product market presented on the Internet, as well as to study the composition of the real and potential groups of customers.

The extraction of the knowledge can be defined as the search and study of the marketing information. To solve these research tasks, the following approaches are used: automatic search and analysis of data on Web sites, data mining in the detection and study of the information related to the users interests in products and services.

The increase in the amount of data available on the Internet is usually stored in an unstructured form, which has contributed to the emergence of multidimensional databases, as well as tools for operational data analysis (OLAP – Online Analytical Processing technology). Today we use the systems with artificial intelligence, whose task is to efficiently extract and research data from the Internet.

The process of data mining is an integral part of the digital economy, which also analyzes the activity of consumers of goods, as well as exploring the most popular ways to visit the Internet. To solve these problems, unstructured Internet data is used. Trading platforms analyze a large amount of information and store it in multidimensional databases using cloud technologies. Sources of information are also reference websites that contain information on every page that is linked to. Sites are browsed by programs on the Internet and contain personal data of users.

The main consumers of electronic banking systems are trading platforms that sell or provide services on the Internet. The main tasks for them are the personalization of the consumer of goods and services, conducting effective advertising work and simplifying the work. Such systems are of interest to Internet providers. The main areas of application in this case are the optimization of the Internet, the minimization of traffic and the optimization of services provided using intelligent systems.

Modern Internet systems provide the ability to identify a user and obtain statistical information about a user's interests. Such software applications allow to determine the turnover, the intensity of calls to different information, addresses of individual users with the ability to analyze the relationship between references to data sources and information.

Today, obtaining information at the level of the trading platform – the consumer is the main component for developing a strategy for the work of the product manufacturer. This can be used to obtain information about the priorities and interests of consumers of the goods. In addition, one of the methods for which the study of patterns in the commodity market is the main task is Data Mining technology. Traditionally, all Internet resources automatically process events, and this information is stored in the relational databases.

The relational databases have disadvantages. The main disadvantage is the storage of the incomplete information and the impossibility of storing unstructured data. The calls to the web pages stored on Internet servers are stored in the server log, and the data is sent using the POST method. An alternative method of analyzing data on the server itself is a study at the packet level. Thus, it is possible to conduct studies at the level of individual TCP/IP requests or save such data using cloud storage.

The analysis of access to the data on the server can provide information about the consumer's interest as well as the nature of web browsing, as well as an anonymous group of the users using a single network access point. Using specialized software will help to achieve the benefits of the trading platform on the Internet. The expanding marketing research opportunities can be solved by cloud technologies (cloud storage and cloud computing).

A large amount of statistical data requires convenient presentation of information for solving marketing research. As such a platform, multidimensional databases (OLAP) can be used since traditional, built on the basis of relational repositories, are deprived of the opportunity. They cannot be analyzed and investigated and the result of the research can be obtained in the form of "slices" of data. OLAP is such a tool.

Although OLAP is not a necessary attribute of a data warehouse, it is increasingly used to analyze the information accumulated in this data warehouse.

The system of on-line processing of Internet data based on OLAP can be represented as follows (Fig. 3).

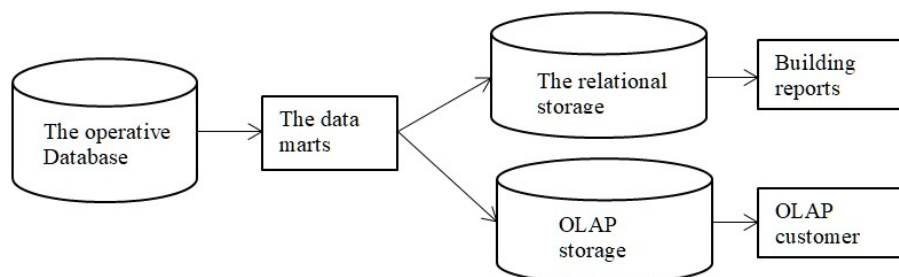

Fig. 3. Online data processing system based on OLAP technology.

The operational data is collected from various sources, filtered into the data marts and stored in a relational repository. At the same time, they are already available for analysis using various report generation tools. The next step is to prepare the data for building multidimensional databases for OLAP analysis. The main element is the metadata, i.e. information on the structure, location and transformation of the data. This ensures the effective interaction of various components of the repository.

Summarizing, you can define OLAP as a combination of the multidimensional analysis of the data accumulated in the repository. OLAP provides the enterprise with the most convenient and fast means of accessing, viewing and analyzing business information. Most importantly, OLAP provides the user with a natural, intuitive data model, organizing them in the form of multidimensional cubes. The axes (dimensions) of the multidimensional coordinate system are the main attributes of the analyzed marketing process. So for the sales process it can be a product category, region, type of buyer. Almost always time is used as one of the measurements. Inside the cube there are data that quantitatively characterize the process – the so-called measures. These can be sales in pieces or in monetary terms, stock balances, costs, and others. The user of marketing research can choose arbitrarily any “slice” in a cube of the data in different directions and receive summary information on the years, quarters, months, days that he needs for the analysis.

First of all, it should be noted that since the marketer always operates with certain summary data, so-called aggregates, that is, pre-calculated totals, are almost always stored in OLAP databases along with detailed data. The examples of aggregates can serve as the total sales for the year or the average balance of goods in stock. Storing pre-computed aggregates is the main way to increase the speed of OLAP queries.

The integration of the data warehousing with the formation systems (data marts) is a complex task, which is aimed at obtaining an exhaustive set of marketing functions. The main advantage of integration with the accounting system is the ability to quickly create for the user a set of reports and models for the study of various areas of economic activity of the trading platform.

In this case, all the efforts of the developer will be reduced to solving the problems of reengineering. The most important task is to create an efficient storefront structure. Since a regular accounting system is optimized only for storing information, the data fields are spread across thousands of tables. Therefore, the search for fields describing a specific query is both a time-consuming and a slow process that adversely affects the performance of the database.

In Fig. 4 shown the trading floor system for the sales data mart.

To optimized the coordinated storefronts is to create a structure that would allow the most expeditiously analyze the data and produce reports, quickly providing the marketer with the necessary information about the results of the analysis.

Based on the proposed concept and data processing system based on OLAP technologies, it is possible to offer the following axiomatic marketing processes:

In the digital marketing system all functional modules corresponding to the marketing functions are equivalent from the point of view of the classical approach. That is, if everyone is truly a marketing function (of a set) $M(n)$ has the property $A()$, then there is a set for which $nM(n)$ is true:

$$(n): A(\beta) \supset M(n) \rightarrow \exists nM(n) \quad (4)$$

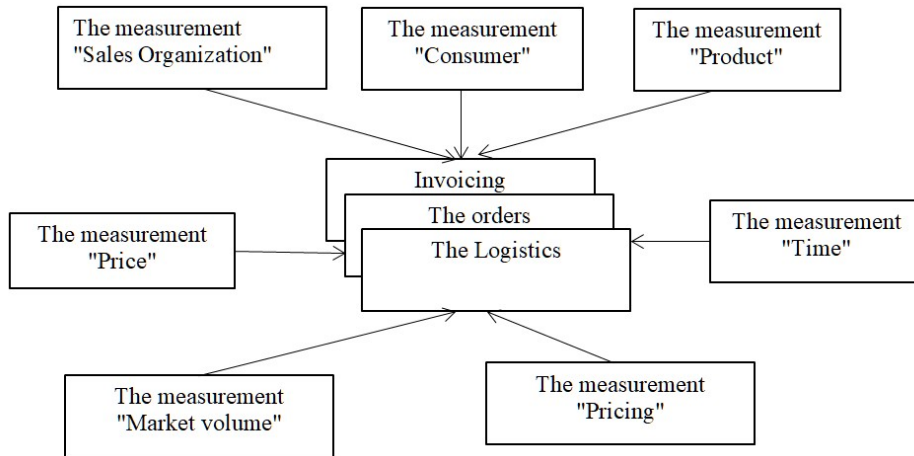

Fig. 4. The trading floor system for sales data marts.

In the digital marketing system, segment directions are selected, which determines the R_{pr} solution. If for all intersections of the set of solutions of the digital marketing system (marketing R_m , logistics R_l and others) is not an empty set, then there is a marketing solution R_{pr} :

$$R_m \cap, \dots, \cap R_l \rightarrow R_{pr}. \quad (5)$$

The ability to use digital marketing systems to solve problems of analysis, management, sales and control, taking into account the development of the target market, consumer demand, product range, competitors and others:

$$S(m) = \{S(i), \dots, S(l)\}. \quad (6)$$

Thus, the proposed approach and method for assessing consumer demand in the target market is aimed at managing trading platforms with regard to marketing research and involves the use of digital marketing systems. There have been analyzed and proposed a marketplace system for the sales data mart using OLAP-technology. The axiomatic marketing processes are proposed.

References

1. Smith, K.T.: Digital marketing strategies that millennials find appealing, motivating, or just annoying. *Journal of Strategic Marketing*, **19**(6), 489–499 (2011). doi:10.1080/0965254X.2011.581383
2. Armitage, J.: Strategic insights. *Marketing Insights*, **27**(1), 22–23 (2015)

3. Gaikwad, M., Kate, P. H.: E-marketing: A modern approach of business at the door of consumer clear. *International Journal of Research in Commerce & Management*. 7(9), 56–61 (2016)
4. Longo, D.: Why Strategy Must Come First in Digital Marketing. *Convenience Store News*, 52(5), 57–60 (2016)
5. Kingsnorth, S.: *Digital Marketing Strategy: An Integrated Approach to Online Marketing*. Kogan Page, London (2017)
6. Halitsyn, V.K., Kaminsky, O.E.: Monitoring of cloud services deployed in a multi-cloud environment. *Modeling and Information Systems in Economics*. 94, 160–169 (2017)
7. Kotler, P., Keller K.L.: *Marketing Management*. Pearson India, Chennai (2017)
8. Kravchenko, V.N.: *Tools for problem-oriented business process management*. Dnepropetrovsk (2014)
9. Lukyanchenko, V.V.: Marketing approaches in the management of a production enterprise with an innovative resource and in the formation of a new business model. *Business Inform.* 4, 154–158 (2011)
10. Lysenko, Yu.G., Andrienko, V.N., Ivanov, N.N.: *Computer science and computer technology: E-commerce*. South-East Ltd, Donetsk (2004)
11. Lysenko, Yu.G., Guz, N.G., Ivanov, N.N.: *Management of the marketing potential of an enterprise*. South-East Ltd, Donetsk (2005)
12. Rezhetskova, I.L.: Marketing in direct logistics channels: current trends. *Marketing in Ukraine*. 1(88), 46–53 (2015)
13. Ivanov, S.M.: Modeling of cooperative connections in the digital economy. *Modeling and Information Systems in Economics*. 96, 108–117 (2018)
14. Ivanov, N.N.: Information and analytical systems in the management of economic objects. *Business Inform.* 10(429), 141–145 (2013)
15. Ivanov, M.: The digital marketing with the application of cloud technologies. *SHS Web of Conferences*. 65, 04019 (2019). doi:10.1051/shsconf/20196504019

Consideration of Risk and Safety in Metamodeling System of Stratification

Valdemar Vitlinskyi

Kyiv National Economic University named after Vadym Hetman, 54/1, Peremohy Ave., Kyiv,
03057, Ukraine
wite101@meta.ua

Vyacheslav Glushchevsky

Zaporizhzhya National University, 9, Engineer Preobrazhensky Ave., Zaporizhia, 69000,
Ukraine
gluschevsky@ukr.net

Abstract. The development of the concept and tools of stratification metamodeling (SMM) is proposed, which is a new object-oriented methodological approach to the synthesis of a complex model of the economic system (enterprise), in particular, in order to distinguish the set of variants of the combination of heterogeneous object-components of its various strata into a single hierarchical structure. It is emphasized that it is necessary to consider conceptual provisions and tools for evaluation and management of such systemic characteristics as safety and risk in the system of the SMM in order to increase the sustainability of the economic system under consideration.

Keywords: risk management, economic security, stratification of hierarchical systems, metamodeling, architectural methodology, enterprise reference modeler, informational technologies.

1 Introduction

Socioeconomic systems (SES), first of all anthropogenic microeconomic systems, objectively inherent risks that are permanently modified in the dynamic environment, conflict with each other, creating new, unknown till present time risks. By substantially reducing one of the risk groups, we can thus increase the risks associated with another group. The multidimensionality of these risks permanently creates threats to the economic security of the SES.

In our opinion, economic security is an integrated system characteristic, which depends on the stability, the permissible level of risk, the controllability of parameters in order to ensure the development and protection of vital economic interests of the individual and society, economic stability of the subjects of economic relations and the economy as a whole [1].

Adding of the principle of uncertainty and the resulting risk in the axiomatics of economic systems functioning makes it more appropriate to consider complex economic systems as self-evident, and also points to the need to consider, evaluate and manage the degree of risk in the system of economic security.

We emphasize that risk is one of the key features of the essence of being, a systemic characteristic in the field of economics. As we have emphasized, the risk has a dialectical objective-subjective structure, as discussed in detail, in particular in [2]. One can give such a definition of the risk in the economy.

Risk is an economic category that characterizes the degree of threats posed by possible losses, failures, deviations from goals, and lowering the level of security. At the same time, risk reflects the peculiarities of the perceived interest of the subjects concerned in economic relations of uncertainty, conflict, threats connected with the current state and the predicted course of events that can lead both to the positive (desirable) and to the negative (undesirable) economic result, from taking into account direct and inverse relationships.

Risks are manifested as threats to the stable (planned) functioning of the SES (hereinafter referred to as enterprises). The current state and prospects of economic development of Ukraine and its industrial segment are characterized by a number of existing problems, in particular such as: radical transformation of global chains of value creation and complication of information structure of modern enterprises; asynchronous management of cross-enterprise processes, digitalization and intellectualization of their control systems; the complexity of tasks solved by managers of all levels due to the ambiguity of situations due to the increase in the number of significant factors and the significant growth of the problem in a holistic and comprehensive analysis of these situations, taking into account the revealed hidden underlying relationships and factors; combining and mixing various technologies of the physical, digital and biological worlds on the basis of a single information platform, etc.

Decision-making process is entrusted to a person (the head of a certain rank), but the activity of people is objectively limited due to the diversity and super-high structural-logical-functional complexity of the investigated phenomena and processes of the subject area on the one hand, and on the other – on the one hand, and on the other, partial absence of a priori information about the probable movement of the economic system and the natural limitations of the human brain in analyzing the tree of events in their interconnection, complementarity, and / or vice versa, the mutual exclusion etc. Therefore, it is logical to involve in the processes of decisions substantiation of modern information technologies (IT) to strengthen the work of the human brain and create on this basis a human-machine decision support systems, which requires the transformation of existing business models of operational type into digital models of activities that support full automation, robotizing, computerization of all functional areas of the enterprise, work with large data sets and are the basis for creation of supercomplicated and super-powerful control systems based on corporate IT.

The rapid development of IT and their application to the automation of managerial processes generated an important direction of intellectualization of processes supporting management decisions – automation of counteraction to threats to the

enterprise and, as a consequence, elimination or risk reduction of occurrence of unwanted events (threats) by the way of developing of information-analytical and intelligent systems of automated decision support with elements of artificial intelligence and their introduction into the practice of traditional management of enterprises [3-6].

Under these conditions, for enterprises and economic systems of different levels, the problem of aggregation of large volumes of information – the results of monitoring of a variety of aspects of the activity of the environment – is being updated. The latter significantly alter the input parameters of management models, may have a destabilizing effect, and, therefore, cause an increase in the uncertainty of the situation and the resulting risk and, as a consequence, the instability of the economic system.

Enterprises that are interested in increasing the stability of their own business and the predictability of development trajectories, evaluate the level of awareness of the tendencies and regularities of processes in the external environment as a measure of conceptual advantage. It is precisely this – the targeted security-protection meaning becomes an economic risk in the information (digital) economy, and the corresponding change in the managerial and model paradigm is grounded historically and methodologically [2, 7-10].

Mathematical modeling as a method of researching of processes and phenomena has become the intellectual core of information technology for the analysis, foundation and adoption of rational and effective solutions in the field of economics and entrepreneurship. But now there is an urgent need for a substantial rethinking of the methodological provisions and tools used in the theory and practice of economic and mathematical modeling.

Rational and most expedient is the combination in the modeled system of adaptive enterprise management of the principles and elements of system, situational, process, marketing and other approaches to management in order to form qualitatively new structures and management mechanisms; it should be based on the quality management system, comply with international and Ukrainian standards, the observance of which guarantees the quality of products and services, as well as the high efficiency of the management system [11].

In recent decades, proactive management acquires in the modeling of economic systems, which is understood as purposeful activity, which involves the activation of systemic transformations that lead to the formation of potentially promising states of the economic system in order to maintain its parameters of life, functioning and development. In particular, the work of [12] formulates the principles which were laid down in the basis of a practical approach. This paper also emphasizes the need to consider the uncertainty and generated risk in the system of proactive management.

It is also important that the predictions of key indicators and parameters can be developed more precisely, based on artificial intelligence tools, by implementing alternative scenarios of events and the development of the external environment and the researched system, which are necessary for making well-balanced decisions. It is also necessary to take into account new types of uncertainty, conflict and the resulting risk, the security and viability of the analyzed economic systems [1].

It should be noted that in our time the conceptual provisions concerning metamodeling have developed considerably, and the stratification tools are developing as the basis for engineering modeling of control systems. At the same time, it is important to synthesize the methodology of metamodeling and stratification tools based on the system-synergistic approach [11, 13-21].

Scientists are intensively and fruitfully working on the development of methodological foundations and the corresponding mathematical tools for modeling adaptive control systems based on the stratification metamodeling methodology for system synthesis and coordination of asynchronous models of dynamically interacting subsystems of the analyzed economic systems in order to increase the validity and efficiency of managerial decisions. In our opinion, the perspective direction in the simulation of economic systems and processes is the synthesis of artificial systems of intelligence enhancement and the methodology and tools of stratification metamodeling. Therefore, it is necessary to develop intensively the scientific research in this direction [11].

2 Result and Discussion

2.1 Glossary

We suggest using the following concepts (author's development) [11]:

Stratification – an analysis of the enterprise from different points of view (modeling aspects) and the corresponding perspective multi-dimensional decomposition with the purpose of developing and synchronizing different segments of knowledge (stratum) with the simultaneous logical integrity of all of these knowledge.

The technology of metamodeling – a system of forms, methods, tools, methodological techniques and procedures of hierarchical modeling, with the application of which the structural and functional structure of the enterprise is considered from a certain point of view considering the objectives of the study.

Stratification metamodeling is a new (proposed by the authors) object-oriented approach to the synthesis of a complex enterprise model in order to select a plurality of variants of unification of heterogeneous object-components of its various stratum into a single hierarchical structure – *the stratification metamodel* of the enterprise, on which basis a system multivariate analysis and dynamic evaluation of the combined effect of different objects of each stratum on the variability of adaptive management of enterprise cross-processes is done.

Metamodel of stratum is a complex model of an enterprise that allocates certain levels of abstraction (*meta-levels*) in the description of enterprise objects and a plurality of their models located at different meta-levels, and ensures their logical and algorithmic consistency at meta-levels and between them within this stratum.

Stratification metamodel of the enterprise is a spatial structural and functional complex model that unifies, organizes and synchronizes information interconnections between heterogeneous models of object-components (local model complexes) of all strata in the scale and context of the enterprise as a whole.

2.2 Methodology

We propose reengineering of the enterprise management system based on a unified corporate information system, taking into account the priority of decentralization of management, preferential modeling of business processes of the enterprise as a network structure on the basis of the *stratification metamodeling methodology (SMM)*. Let us highlight the following main stages of the practical application of *SMM-methodology*.

Stage 1. Development, introduction, improvement of the enterprise quality management system based on the international standards of the ISO 9000: 2005 series, IDT, ISO 9001: 2008, IDT (with additions) taking into account the specifics of the classes of enterprises grouped by types of economic activity [22].

Stage 2. Model reengineering of the functional structure of the enterprise (model of the network of business processes): system decomposition of the enterprise into separate parts (organizational units, functional departments, business processes, etc.); reengineering of business processes taking into account the results of modeling of multidimensional structural and functional relationships between the allocated components [23].

Stage 3. Mathematical support of corporate information systems for information support of managerial processes is based on integrated models of enterprise activity, application of which provides model compatibility, balance and functional interoperability of heterogeneous object-components of a single corporate information model of enterprise management system. Consideration, quantification of risks and safety, as well as models of management of these system characteristics, considering the dialectical objective and subjective risk structure [24].

Stage 4. Synthesis of the ERM-model (or ERM-solution – Enterprise Reference Modeler) of the enterprise management system based on the *principles of stratification* applied to the complex model of the enterprise:

- the processes of functioning of the enterprise are described in various aspects and with different levels of abstraction (the isolation of *strata*);
- *METAMODEL* complex model is represented by a set of structural, functional and informative models;
- the synthesis of these models into a single complex, the establishment of the coordination links between model components, the introduction of a uniform format of indicators, parameters, data for information exchange in the scale of the entire model complex is carried out using the methodology and tools of stratification metamodeling, in which systems are systematically integrated methods of structural and functional and object-oriented modeling, graphic description of the structures of simulated enterprise subsystems, metadata-based technologies grounded on MDD models (Model-Driven Development) and other tools for integrating models (nested, hierarchical structures) [4, 25].

Stage 5. Designing a single corporate information ERM-model of an enterprise-wide management system based on BPM – a concept (Business Performance Management) that implements an innovative approach to management – automated support for a complete cycle of business efficiency management aimed at optimizing the

implementation of strategic development of an enterprise by the way of integrating cyclic analytical processes supported by relevant information technologies [26].

2.3 Modeling

Model support for selected stages of the practical application of *SMM-methodology* is provided by the *SMM toolkit* – various mathematical, software and hardware tools, case studies of relevant normative and legal documentation are developed.

Stage 1. Development of ISO 9000 series standards for a specific enterprise based on TQM (Total Quality Management) [22, 26].

Stage 2. The modeling of the company as a complex dynamic system in the form of the stratification metamodel *METAMODEL* involves the creation of integrated two of its complex models *MODEL^{OS}* and *MODEL^{BP}*, functional and logical connections of structural elements which are coordinated among themselves on the basis of the toolbox SMM [11].

2.1. The first aspect of enterprise modeling (first stratum). The object model *MODEL^{OS}* of the general virtual organizational management structure (OMS) is proposed, which is constructed using the tools of graph theory and organizational modeling based on its real analog as an artificial mixed-type OMS taking into account various conceptual models (linear, functional, matrix, design, network OMS models and their combinations) and presented in the form of an oriented weighted graph:

$$MODEL^{OS} = \langle V^{OS}; E^{OS}; W^{OS} \rangle, \quad (1)$$

where $V^{OS} = \{OS_i\} = \{OS_{i\alpha_i}\}$, $E^{OS} = \{\Gamma; \Omega\}$ – is the set of vertices and arcs respectively of the *MODEL^{OS}* graph, $i \in I$, $\alpha_i \in A_i$ – identifiers; OS_i , OS_{i_1} , OS_{i_2} – structural divisions of the enterprise (i , i_1 , i_2 – their identifiers);

$$\begin{cases} \Gamma: V^{OS} \times V^{OS} \rightarrow \{-1; 0; 1\} \\ \Omega: V^{OS} \times V^{OS} \rightarrow \{0; 1\}, \end{cases} \quad (2)$$

where $\Gamma = \{\gamma_{i_1 i_2}\}_{i_1, i_2 \in I}$ – is the set of direct control pulses, which is represented by a modified adjacency matrix: $\forall i_1, i_2 \in I, i_1 \neq i_2: \gamma_{i_1 i_2}: OS_{i_1} \times OS_{i_2} \rightarrow \{-1; 0; 1\}$; $\Omega = \{\omega_{i_1 i_2}\}_{i_1, i_2 \in I}$ – is the set of inverse regulating responses, which is represented by the adjacency matrix: $\forall i_1, i_2 \in I, i_1 \neq i_2: \omega_{i_1 i_2}: OS_{i_2} \times OS_{i_1} \rightarrow \{0; 1\}$; $W^{OS} = \{\Psi; \Phi\}$ – is a system of measured functions that are given on the sets V^{OS} and E^{OS} of the *MODEL^{OS}* graph, respectively.

2.2. Adapting the enterprise to change by creating a “target design teams” to solve actual problem situations (countering threats to economic security) involves decomposing using the technology of metamodeling of the general model *MODEL^{OS}* into partial models in the form of oriented weighted subgraphs *MODEL^{OS}*:

$$MODEL^{OS} = \left\{ ML_{\pi}^{(1)} \right\}_{\pi \in \Pi} \quad (3)$$

$$\begin{cases} ML_{\pi}^{(1)} = \langle V_{\pi}^{OS}; E_{\pi}^{OS}; W_{\pi}^{OS} \rangle; \\ V_{\pi}^{OS} = \{OS_i\}_{i \in I_{\pi}}; V_{\pi}^{OS}: CM_{\pi} \times V^{OS} \rightarrow \{0; 1\} \\ E_{\pi}^{OS} = \{\Gamma_{\pi}; \Omega_{\pi}\}; W_{\pi}^{OS} = \{\Psi_{\pi}; \Phi_{\pi}\} \end{cases} \quad (4)$$

where $ML_{\pi}^{(1)}$ – partial models of the virtual OMS of the enterprise, which are artificially constructed to solve the actual problem situation π ; V_{π}^{OS} , E_{π}^{OS} , W_{π}^{OS} – are the sets of vertices corresponding to the arcs of the graph $ML_{\pi}^{(1)}$ and the system of weighted functions given on the sets V_{π}^{OS} and E_{π}^{OS} , $\pi \in \Pi$, $I_{\pi} \subseteq I$, $\Gamma_{\pi} \subseteq \Gamma$, $\Omega_{\pi} \subseteq \Omega$, $\Psi_{\pi} \subseteq \Psi$, $\Phi_{\pi} \subseteq \Phi$; CM_{π} – is a target conceptual model that is constructed to solve the actual problem situation $\pi \in \Pi$.

2.3. *The second aspect of the enterprise modeling (second stratum)*. Integrated modeling of the business processes (BP) network of the enterprise was carried out using the metamodeling technology in the form of a directed graph $MODEL^{BP}$:

$$MODEL^{BP} = \langle V^{BP}; E^{BP} \rangle, \quad (5)$$

where $V^{BP} = \{BP_n\} = \{FS_{j_n}^n\}$, E^{BP} – the set of vertices and arcs of the graph $MODEL^{BP}$ respectively: *vertices* (heterogeneous objects) – models of individual business processes $\{ML_n^{(2)}\}$; *arcs* – coupling between pairs BP_{n_1} and BP_{n_2} ; $n \in N$, $j_n \in J_n$ – identifiers.

2.4. *Model reengineering of business processes* for their continuous improvement. The set of objects of model $MODEL^{BP}$ is formed by models $ML_n^{(2)}$ of individual business processes of the enterprise, which is built on the basis of international standards of quality of series ISO 9000 in the form of oriented weighted graphs:

$$ML_n^{(2)} = \langle V_n^{BP}; E_n^{BP}; \tilde{W}_n^{BP} \rangle, \quad n \in N \quad (6)$$

$$\begin{cases} V_n^{BP} = \{FS_{j_n}^n\}_{j_n \in J_n} \\ E_n^{BP} = \{FS_{j_n}^n\}_{n \in N} = \{(FS_{j_1}^n; FS_{j_2}^n)\}_{n \in N, j_1 \neq j_2, j_1, j_2 \in J_n} \\ \tilde{W}_n^{BP} = \langle DEM_n^2; DEM_n^4; BRES_n; W_n \rangle_{n \in N} \\ \left[\begin{array}{l} FS_{j_n}^n: V_n^{BP} \times V_n^{BP} \rightarrow \{0; 1\} \\ DEM_n^2: BP_n \times RS_r \rightarrow \{0; 1\} \\ DEM_n^4: BP_n \times PR_p \rightarrow \{0; 1\} \\ BRES_n: BP_n \times RS_r \rightarrow \mathbb{Z}^+ \end{array} \right. \end{cases} \quad (7)$$

where V_n^{BP} , E_n^{BP} – are the sets of vertices and arcs respectively of the graph $ML_n^{(2)}$; $FS_{j_n}^n$, $FS_{j_1}^n$, $FS_{j_2}^n$ – functional blocks of the n business process model (j, j_1, j_2 – their identifiers within the business process “ n ”); \tilde{W}_n^{BP} – is the system of weighted functions (objects) given on the sets V_n^{BP} and E_n^{BP} of the graph $ML_n^{(2)}$, $n \in N$, in particular: $DEM_n^2 = \{d_{nr}^2\}$ – is a function of consumption of resources from the set RS_r , $r \in R$, on the elements of the n th business process BP_n ; $DEM_n^4 = \{d_{np}^4\}$ – output function of the product of the set PR_p , $p \in P$, for the n business process BP_n ; $BRES_n = \{b_{nr}\}$ – the function of providing the n th business process BP_n the volume of r -type resources from the set RS_r , $r \in R$; W_n – the set of administrative tasks of the enterprise (object) that are solved on

the functional elements of the business process BP_n ; \mathbb{Z}^+ – is the set of integer positive numbers.

2.5. The formalization of “joints” between the pairs of business processes in the model structure $MODEL^{BP}$ is carried out using the models in the form of dual-fraction oriented graphs of a special structure:

$$G_{n_1 n_2} = \langle V_{n_1 n_2}; E_{n_1 n_2}; W_{n_1 n_2} \rangle \quad (8)$$

$$\left\{ \begin{array}{l} V_{n_1 n_2} = V_{n_1} \cup V_{n_2}, V_{n_1} = \{FS_{j_{n_1}}^{n_1}\}, V_{n_2} = \{FS_{j_{n_2}}^{n_2}\} \\ E_{n_1 n_2}: V_{n_1} \times V_{n_2} \rightarrow \{0; 1\}, E_{n_1 n_2} = \{(FS_{j_{n_1}}^{n_1}, FS_{j_{n_2}}^{n_2})\} \end{array} \right\} \quad (9)$$

where $V_{n_1 n_2}$, $E_{n_1 n_2}$ – are the plural of the graph $G_{n_1 n_2}$ – respectively, the vertices (functional elements $FS_{j_{n_1}}^{n_1}$ and $FS_{j_{n_2}}^{n_2}$, which are the “joints” of business processes BP_{n_1} and BP_{n_2} respectively) and arcs that connect them; $W_{n_1 n_2}$ – is a system of weighted functions (objects) given on the sets $V_{n_1 n_2}$ and $E_{n_1 n_2}$ of the graph $G_{n_1 n_2}$, $n_1, n_2 \in N$, $n_1 \neq n_2$, $j_{n_1} \in J_{n_1}$, $j_{n_2} \in J_{n_2}$.

Step 3. To construct a comprehensive enterprise model, we suggest using a combination of the most well-known and recognized in the world of architectural methodologies: the Zakhman model, the TOGAF (The Open Group Architectural Framework), the FEA (Federal Enterprise Architecture) methodology, the Gartner methodology, the EAP method (Enterprise Architecture Planning, as well as methods of structural analysis and design of business processes (IDEF, ARIS, their modifications and applied notations, MS Visio, etc.) [4, 6, 27-32].

Stage 4. The reengineering of business processes of the enterprise is carried out on the basis of the model of the $MODEL^{MS}$ of the spatial interaction of the organizational and functional structures of the enterprise by the way of integration of the object elements of their models $MODEL^{OS}$ and $MODEL^{BP}$ respectively (formulas (1) - (9)) with the use of SMM tools. The complex ERM model of the enterprise management system $MODEL^{MS}$ is presented in the form of the oriented weighted graph with the formulas (10) - (12):

$$MODEL^{MS} = \langle V^{MS}; E^{MS}; \tilde{W}^{MS} \rangle \quad (10)$$

$$\left[\begin{array}{l} V^{MS} = V^{OS} \cup V^{BP} \\ E^{MS} = V^{OS} \times V^{BP} \rightarrow \{0; 1\} \\ \tilde{W}^{MS}: \langle P^1; P^2; \tilde{U}; W \rangle \end{array} \right] \quad (11)$$

$$\left\{ \begin{array}{l} P^1: V^{OS} \times FR \rightarrow \{0; 1\} \\ P^2: V^{BP} \times FR \rightarrow \{0; 1\} \\ \tilde{U}: V^{OS} \times V^{BP} \times FR \rightarrow \{0; 1\} \\ W: \tilde{U} \times RES \times PROD \rightarrow \bar{W} \end{array} \right\} \quad (12)$$

where:

$V^{MS}, V^{OS}, V^{BP}, E^{MS} = \{e_{i\alpha_i n_j n}\} = \{(OS_{i\alpha_i}; FS_{j_n}^n)\}$, \tilde{W}^{MS} – is the set of vertices of $MODEL^{MS}$, $MODEL^{OS}$, $MODEL^{BP}$, arcs of the $MODEL^{MS}$ graph, and the system of objects (functions, weights, matrices described above), which are given on its sets V^{MS}

and E^{MS} , respectively, in particular: $P^1 = \{\rho_{i\alpha_i sh_s}^1\}$, $P^2 = \{\rho_{nj_n sh_s}^2\}$ – matrix identifiers of the “bindings” of the functional works r_{sh_s} from the set FR , $s \in S$, $h_s \in H_s$, to elements $OS_{i\alpha_i} \in V^{OS}$ and $FS_{j_n}^n \in V^{BP}$ in accordance; $\tilde{U} = \{\tilde{u}_{i\alpha_i nj_n}\}$ – is the matrix-identifier of the direct management guidance pulses by the unit $OS_{i\alpha_i}$ on the functional block $FS_{j_n}^n$; W , \bar{W} – are the sets of management tasks $w_{n\lambda_n}$, which are solved by the units $OS_{i\alpha_i}$ on the functional elements $FS_{j_n}^n$ business processes of the enterprise using the resource set of RES for the production of the product the $PROD$ set and the information descriptions $\bar{w}_{n\lambda_n}$ of their content statements: $W = \{w_{n\lambda_n}\}$, $\bar{W} = \{\bar{w}_{n\lambda_n}\}$, $RES = \{RS_r\}$, $PROD = \{PR_p\}$, $n \in N$, $\lambda_n \in \Lambda_n$, $r \in R$, $p \in P$.

Stage 5. Models of modern corporate information systems are developed on the basis of model stratification of the enterprise on a modular basis and contain a set of metamodels that are programmed implemented with the help of multifunctional information management technologies with a set of business applications (architectural modules) at the level of databases and knowledge for certain subject areas, which are adapted to the specifics and conditions of the operation of a particular enterprise. These methodological principles of modeling are the basis for the creation of the architecture of a single corporate information *ERM*-model enterprise management system based on the BPM-concept (Figure 1), which is endowed with referential properties and can be adapted and implemented at other enterprises that are related according to industrial and / or sectoral sign.

2.4 Architecture of *ERM*-model

The architecture of a single corporate information *ERM*-model of an enterprise management system, which we offer within the framework of the SMM methodology, allows the inclusion, if necessary, to the basic BPM platform of separate specialized analytical techniques presented by separate IT-modules, in particular, such (Figure 1) [33-36].

BPM (Business Performance Management):

functionality of the module – automated support of the full cycle of management of the efficiency of activity at all levels of the enterprise by way of unification of owners, managers, personnel and external contractors within the general integrated management environment based on a single corporate information model of the enterprise;

modeling tools – methods: functional-cost (ABC-Costing), scenario, situational and plan-fact analysis; methodology of the BSC (Balanced Scorecard); BI applications (Business Intelligence: data warehouses and displays, OLAP technologies, intelligent data analysis, etc.); AIN (Analytic Infrastructure) and DIN (Data Infrastructure) integration technologies for functional and informational collaboration of BPM-based applications from external sources (BPM-compliant with APS / CRM / SCM solutions, ERP / ERP II class systems), IAS set, CALS-technologies, etc.); ITIN-technology (IT-infrastructure: servers, data storage hardware, computing networks, operating systems, etc.); B2G (Business-to-Government) and G2B (Government-to-Business) application-based software solutions, such as e-procurement systems, electronic tenders, etc.

ERP II (Enterprise Resource and Relationship Processing):

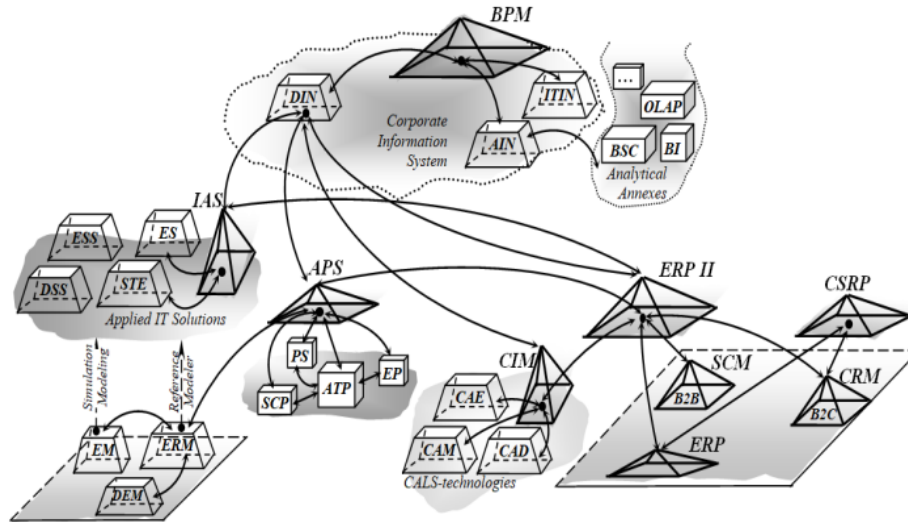

Fig. 1. Architecture of a single corporate information *ERM*-model of enterprise management system based on BPM-concept.

functionality of the module – integrated management of an enterprise of a certain type of economic activity (for sectoral / industrial segments) by way of automating cross-processes through their optimization, IT support and the introduction of automated CRM (Customer Relationship Management) and supply chains (SCM-Supply Chain Management) based on Internet technologies;

modeling tools – methods and models of logistics (SCM-module), Internet-based technologies on the basis of B2B and B2C platforms (Business-to-Business and Business-to-Consumer – application software solutions such as CRM components for the implementation of interactive interaction respectively, “enterprise-executor-enterprise-customer” and “enterprise-client”), tools of the basic ERP-system, applied APS-system, control systems by databases and OLAP-technologies, etc.

CSRP (Customer Synchronized Resource Planning):

functionality of the module – synchronization of business processes of the enterprise with the needs and expectations of consumers of its products by the way of business process reengineering and virtualization of its units and services;

modeling tools – Internet-based technologies B2C-platforms, tools of the basic ERP system, applied APS-systems, control systems by databases and OLAP technologies, etc.

ERP (Enterprise Resource Planning):

functionality of the module – effective planning and management of all resources of the enterprise to provide an organizational strategy for the integration of production and operations management of labor resources, financial management and asset management;

modeling tools – methods, models, algorithms of the theory of production planning, statistical and economic analysis, the theory of schedules, group support decision-

making, investment analysis, management accounting, financial and personnel management, etc.

IAS (Information and Analytical System):

module functionality is a human-computer system whose analytical modules together form a multifunctional integrated information system, with which the support for decision-making is supported;

modeling tools – traditional optimization methods: MathCAD, MATLAB; statistical data processing: STE (Statistica Enterprise), SPSS (Statistical Package for the Social Sciences); ES (Expert System), DSS (Decision Support System), ESS (Executive Support Systems), etc.

CIM (Computer Integrated Manufacturing):

functionality of the module – the integrator of separate computer systems and CALS-technologies into a single system for the automation of the entire production process from designing products to their manufacturing;

modeling tools – tools of the basic ERP system, applied CALS-technologies integrated with ERP system: CAD (Computer-aided design), CAE (Computer-aided engineering), CAM (Computer-aided manufacturing).

APS (Advanced Planning and Scheduling):

functionality of the module – adaptive management of the enterprise's production cycle for the management of production chains based on the application of economical mathematical methods and models;

component modules (standards):

ATP (Available To-Promise) – comprehensive assessment of the ability to execute the scheduled portfolio of orders in scheduled terms;

EP (Enterprise Planning) – optimization of planning processes: capacities, operational, material needs;

PS (Production Scheduling) – volume scheduling;

SCP (Supply Chain Planning) – planning a cumulative production process based on the “production chain” modeling;

EM-application (Enterprise Modeler) – scenario modeling for the development and quantification of the effectiveness of enterprise plans at all levels;

modeling tools – methods and models of mathematical programming, operations research, mathematical statistics, risk analysis, optimal management, decision making, simulation modeling, structural modeling (IDEF, ARIS methodology, etc.), heuristic methods, multicriterion models, object oriented technologies (UML; CBD; DFM, etc.), business process reengineering methods: DEM (Dynamic Enterprise Modeler), ERM-solutions (Enterprise Reference Modeler), other methods and models of economic cybernetics.

The BPM platform provides the implementation of simple analytical functions that are implemented with built-in OLAP tools (generalization / detailing, benchmarking, etc.), and the only corporate information *ERM*-model of the enterprise management system built on the basis of the methodology and with the use of stratification metamodeling tools, enables to solve the actual problem of asymmetry of model information in the system of management of economic safety of the enterprise and has the following advantages:

- universality (the possibility to describe the structure of the *ERM*-model, the characteristics and functionality of the classes of models using the *METAMODEL* stratification metamodel, and the standardization and unification of the models created for various problem areas – *the system evaluation of individual risk groups*);
- modularity (structurization of the *METAMODEL* stratification metamodel as a system of interconnected and conditionally separated local model complexes while maintaining its integrity – *identifying “hidden” links between the components of the detected threat and multi-dimensional assessment of the integration risk of the threat of the onset of a particular problem situation*);
- the system of relations within the hierarchy (at each level of the hierarchy of the *ERM*-model, its individual IT modules may be assigned their own rules for representing their objects and interrelationships between them – *leveling the threat of the “exit” of a particular problem situation beyond the functional of the ERM-model due to the application of its construction of the principles of multilayer hierarchy*);
- adaptability (the ability of the *ERM*-model to flexible modification and extensions of model and hardware complexes at any hierarchical level without a fundamental modification of its structural basis – *model synthesis (model simulation) of a chain of problem situations or a certain set of them*);
- interoperability (the ability of the *ERM*-model to integrate adequately and non-conflict with other external entities in relation to it, formalized objects, excluding any restrictions on mutual access to jointly activated information and computing resources, in particular models, sets of models, model complexes, metamodels of data and knowledge, etc. – *the basis for automated control of the chain of task models through “access points” due to the intellectualization of the decision-making model in the structure of stratification metamodel of METAMODEL*).

3 Conclusion

Thus, the mastery of the principles and mechanisms embodied in the BPM concept enables top management to determine and measure the effectiveness of the enterprise by improving the reflection of the assessment of its own business, on the basis of which to implement program-targeted efficiency management on its basis which is grounded on strategic priorities of the development. The main hidden reserves for obtaining a positive effect from the introduction of BPM-systems built on the basis of the proposed *methodology of SMM*, is saving various types of costs (reducing costs of IT processing transactions in the system optimization of flow processes throughout the production chain; eliminating the risks of making incorrect or false calculations; obtaining a synergistic effect by coordinating processes, optimizing functions, targeted improvement in indicative indicators, etc.) and a long-term competitor and benefits for the next 15-20 years due to the flexibility of management in responding to market changes and as a result ensure high performance and profitability of investment attractiveness.

The *methodology of SMM* is the basis for accumulation and reuse of knowledge when creating templates of *ERM*-models, which are reference for the classes of enterprises, due to the flexible combination of conceptual, mathematical and information descriptions of the models of enterprises with the use of stratification metamodeling tools.

We would like to emphasize that the inclusion of conceptual provisions and tools of safety and risk in the framework of the SMM is a prerequisite for ensuring efficient, proactive management of the SES in the realities of the information (digital) economy.

4 Acknowledgements

This study was supported by the Ukrainian Ministry of Education and Science, Project No. 0116U002596, “Development of Methodology and Toolkit of Modeling Risks in the System of Economic Security”.

References

1. Katunina O.S., Vitlinsky V.V.: Otsiniuvannia rivnia ekonomichnoi bezpeky na pidgrunti modeliuvannia znan (Evaluation of the level of economic security on the basis of knowledge modeling). *Modeliuvannia ta informatsiini systemy v ekonomitsi*. 93, 74–90 (2017)
2. Vitlinsky V.V.: Metodolohichni zasady modeliuvannia ryzyku v systemi ekonomichnoi bezpeky (Methodological basis of risk modeling in the economic security system). *Modeliuvannia ta informatsiini systemy v ekonomitsi*. 94, 5–28 (2017)
3. Portilla, A., Vazquez, J., Harreis, H., Pancaldi, L., Rowshankish, K., Samandari, H., Staples, M. (ed.): The future of risk management in the digital era. <https://www.mckinsey.com/~media/McKinsey/Business%20Functions/Risk/Our%20Insights/The%20future%20of%20risk%20management%20in%20the%20digital%20era/Future-of-risk-management-in-the-digital-era-IIF-and-McKinsey.ashx> (2017). Accessed 29 March 2019
4. Kudrjavcev D.V., Arzumanjan M.U.: Arhitektura predpriyatija: perehod ot proektirovaniya IT-infrastruktury k transformacii biznesa (Enterprise Architecture: Transition From IT-Infrastructure Design to Business Transformation). *Russian Management Journal*. **15**(2), 193–224 (2017). doi:10.21638/11701/spbu18.2017.204
5. Kravchenko V.H.: Proektuvannia avtomatyzovanykh informatsiinykh system. KNEU, Kyiv (2008)
6. Koehler T., Alter S.: Using enterprise architecture to attain full benefits from corporate big data while refurbishing legacy work systems. *CEUR Workshop Proceedings*. **1753**, 1–11 (2016)
7. Vahlakova, V.V.: Ekonomichna bezpekoloheia: stanovlennia nauky (The Formation of the Science of Economic Security). *Probl. of Ec.* 1, 290–296 (2017)
8. Heiets, V.M. (ed.): Modeliuvannia ekonomichnoi bezpeky: derzhava, rehion, pidpriemstvo (Simulation of economic security: state, region, enterprise). INZhEK, Kharkiv (2006)
9. Illyashenko, O.V.: Pobudova systemy ekonomichnoi bezpeky pidpriemstva: pryntsyypovi polozhennia (Building of a system of enterprise economic security: principals). *Efektivna ekonomika*. 11 (2015)

10. Europe 2020: A European strategy for smart, sustainable and inclusive growth. <http://ec.europa.eu/eu2020/pdf/COMPLET%20EN%20BARROSO%20%20%20007%20-%20Europe%202020%20-%20EN%20version.pdf> (2010). Accessed 29 March 2019
11. Glushchevsky, V.V.: Prykladni aspekty zastosuvannya tekhnolohii stratyfikatsiinoho metamodeliuvannya v systemi upravlinnia komertsiiinym bankom (Applied aspects of application of stratificational metamodeling technology in commercial bank management systems). In : Cherniak, O.I., Zakharchenko, P.V. (eds). Applied Aspects of Forecasting Development of the UE, pp. 234–250. Melitopol (2018)
12. Chornous, H.O.: Proaktyvne upravlinnia sotsialno-ekonomichnyh systemamy na osnovi intelektualnogo analizu danykh: metodolohiia i modeli (Proactive management of socio-economic systems on the basis of intellectual data analysis: methodology and models). Kiev University, Kyiv (2014)
13. Van Gigch, J.P.: System Design Modeling and Metamodeling. Plenum Press, New York (1991)
14. Kangassalo, H.: Approaches to the Active Conceptual Modeling of Learning. In: Chen, P., Wong, L. (eds.) Active Conceptual Modeling of Learning: Next Generation Learning-Base System Development, pp. 168-193 (2007). doi:10.1007/978-3-540-77503-4_14
15. Olive, A.: Conceptual Modeling of Information Systems. Springer, Berlin (2007)
16. Mesarovic, M.D.: Multilevel concept for systems engineering. Proc. Sys. Eng. Conf., Chicago (1965)
17. Mesarovic, M.D., Macko, D., Takahara, Y.: Structuring of multilevel systems. Proc. IFAC Symp. Multivariable Systems, Dusseldorf (1968)
18. Nechaev, V.V.: Vvedenie v teoriyu metamodelirovaniia sistem (Introduction to the theory of system metamodeling). Moscow (1997)
19. Ljadova, L.: Metamodelirovanie i mnogourovnevnye metadannye kak osnova tekhnologii sozdaniia adaptiruemykh informacionnykh sistem (Meta-modeling and multi-level metadata as a basis for technologists of creating adaptable information systems). Int. J. "Information Technologies & Knowledge": Int. B. Series "Information Science & Computing". 4, 125–132. <http://sci-gems.math.bas.bg/jspui/bitstream/10525/1093/1/IBS-04-p20.pdf> (2008). Accessed 29 March 2019
20. Lychkina, N.N., Morozova, Ju.A.: Stratifikacija kak osnova inzhenerii tekhnologij komp'juternoj podderzhki prinjatija gosudarstvennykh reshenij v pensionnoj sfere (Stratification as the basis of computer technology engineering support for making state decisions in the pension sphere). Business Informatics. 2(20), 20–28 (2012)
21. Atkinson, K., KJune, T.: Fundament metamodelirovaniia (The foundation of metamodeling). <https://www.osp.ru/os/2003/12/183688/> (2003). Accessed 29 March 2019
22. ISO 9001:2000 Quality management systems – Requirements. http://www.iso.org/iso/catalogue_detail?csnumber=21823 (2000). Accessed 29 March 2019
23. Hammer, M., Champy, J.: Reengineering the Corporation: A Manifesto for Business Revolution. Harper Collins, New York (1993)
24. Novikov, D.A.: Kompleksnye modeli sistemnoj optimizacii proizvodstvenno-ekonomicheskoi dejatel'nosti predpriiatija (Complex models of system optimization of production and economic activity of the enterprise). Large system management, 65, 118–152 (2017)
25. Macko, D.: General systems theory approach to multilevel systems. Systems Res. Center Rep. SRC 106-A-67-44 (1967)
26. ISO/IEC 24744:2014 Software Engineering – Metamodel for Development Methodologies. https://webstore.iec.ch/preview/info_isoiec24744%7Bed2.0%7Den.pdf (2014). Accessed 29 March 2019

27. Seshns, R.: Sravnenie chetyreh vedushhih metodologij postroenija arhitektury predpriyatija (Comparison of the four leading methodologies for building enterprise architecture). [\(https://docs.microsoft.com/ru-ru/previous-versions/dotnet/articles/ee914379\(v=msdn.10\)\)](https://docs.microsoft.com/ru-ru/previous-versions/dotnet/articles/ee914379(v=msdn.10)) (2007). Accessed 29 March 2019
28. ARIS Express – besplatnaja programma dlja modelirovanija biznes-processov i orgstruktury (ARIS Express is a free program for modeling business processes and organizational structures). <http://bpmssoft.org/aris-express> (2014). Accessed 29 March 2019
29. IDEF Family of Methods: A Structured Approach to Enterprise Modeling & Analysis. <http://www.idef.com/>. Accessed 29 September 2018
30. Zachman, J.A.: John Zachman’s Concise Definition of the Zachman Framework. Zachman International, Inc. <https://www.zachman.com/about-the-zachman-framework> (2008). Accessed 29 March 2019
31. Lapalme, J., Gerber, A., Van der Merwe, A., Zachman, J., De Vries, M., Hinkelmann, K.: Exploring the future of enterprise architecture: A Zachman perspective. *Comp. in Ind.* **79**, 103–113 (2016)
32. Machulko, O.I.: Sravnenie metodologij postroenija arhitektur korporativnyh informacionnyh sistem (Comparison of methodologies for building architectures of corporate information systems). *J. Modern trends in the development of science and technology.* **3**(3), 88–89 (2017)
33. ISO 15704:2000 Industrial automation systems – Requirements for enterprise-reference architectures and methodologies. International organization for standardization. <https://www.iso.org/standard/28777.html> (2000). Accessed 29 March 2019
34. Avtomatizacija upravljenja kompanijami: BPM (Automation of company management: Business Performance Management). <http://www.insapov.ru/business-performance-management.html> (2006). Accessed 29 March 2019
35. Business Performance Management Industry Framework Document. Final Version 5.0. BPM Standards Group. <http://www.bmppartners.com/documents/BPMIndustryFramework-V5.pdf> (2005). Accessed 29 Sep 2018
36. Standarty upravljenja MRP, MRP II, ERP, CSRP. CRM-sistemy (Management Standards MRP, MRP II, ERP, CSRP. CRM-systems). <http://kursak.net/standarty-upravleniya-mrp-mrp-ii-erp-csrp-crm-sistemy/> Accessed 29 March 2019
37. Vitlinskyi, V., Glushchevsky, V.: Consideration of risk and safety in stratification metamodeling system. *SHS Web of Conferences.* **65**, 08002 (2019). doi:10.1051/shsconf/20196508002

Detecting Stock Crashes Using Levy Distribution

Andrii Bielinskyi, Vladimir Soloviev^[0000-0002-4945-202X],
Serhiy Semerikov^[0000-0003-0789-0272]

Kryvyi Rih State Pedagogical University, 54, Gagarina Ave, Kryvyi Rih, 50086, Ukraine
{krivogame, vnsoloviev2016, semerikov}@gmail.com

Viktoria Solovieva

Kryvyi Rih Economic Institute of Kyiv National Economic University named after Vadym
Hetman, 16, Medychna St., Kryvyi Rih, 50000, Ukraine
vikasolovieva2027@gmail.com

Abstract. In this paper we study the possibility of construction indicators-precursors relying on one of the most power-law tailed distributions – Levy’s stable distribution. Here, we apply Levy’s parameters for 29 stock indices for the period from 1 March 2000 to 28 March 2019 daily values and show their effectiveness as indicators of crisis states on the example of Dow Jones Industrial Average index for the period from 2 January 1920 to 2019. In spite of popularity of the Gaussian distribution in financial modeling, we demonstrated that Levy’s stable distribution is more suitable due to its theoretical reasons and analysis results. And finally, we conclude that stability α and skewness β parameters of Levy’s stable distribution which demonstrate characteristic behavior for crash and critical states, can serve as an indicator-precursors of unstable states.

Keywords: alpha-stable distribution, stock market crash, indicator-predictor, indicator of critical events, log-returns fluctuations, Dow Jones Industrial Average Index.

1 Introduction

The efficient financial market is an integral part of the modern market economy. With a rapidly growing financial market, new risk management methods are becoming more demanded that take into account new non-Gaussian distributions. The task of monitoring and predicting of possible critical states of financial and economics systems are very relevant today. In our opinion, the availability of the time series for stock markets gives the opportunity to solve such tasks in very effective ways. Financial crises that regularly shake the world economy are characterized by noticeable fluctuations in stock indices, thereby causing noticeable changes in the statistical distributions of empirical data [1, 2]. Consequently, the analysis of the form and parameters of the distribution of price fluctuations of the stock market indexes will make it possible to predict the possible occurrence of the financial crisis.

In 1900, Bachelier proposed the first model for the stochastic process of returns – an uncorrelated random walk with independent, identically Gaussian distributed (i.i.d) random variables [3]. This model is natural if one considers the return over a time scale Δt to be the result of many independent “shocks”, which then lead by the central limit theorem to a Gaussian distribution of returns [3]. However, empirical studies [4-6] show that the distribution of returns has pronounced tails in striking contrast to that of a Gaussian.

For time series $S(t)$ which describes the dynamics of price on stock index, the returns $g(t)$ over some time scale Δt is defined as the forward changes in the logarithm of $S(t)$,

$$g(t) \equiv (\ln S(t + \Delta t) / \ln S(t)). \quad (1)$$

For small changes in the price, the returns $g(t)$ is approximately the forward relative change

$$g(t) \approx \frac{S(t + \Delta t) - S(t)}{S(t)}. \quad (2)$$

To illustrate mentioned above fact, we show in Fig. 1 the daily returns of the DJIA market index for 1900-2019 and contrast it with a sequence of i.i.d. Gaussian random variables.

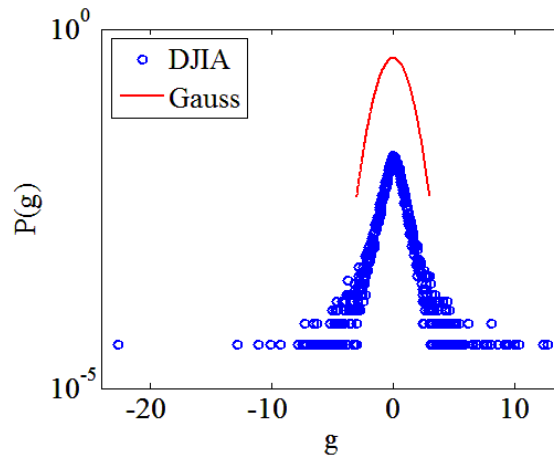

Fig. 1. Probability density function of DJIA daily normalized returns during the period from 1900 to 2019.

It is obvious that the distribution of returns has heavy tails and in the general case can be described as

$$P(g > x) \sim x^{-(1+\alpha)}, \quad \alpha \in (0, 2] \quad (3)$$

and for stock indexes it has a universal look, known as the cubic laws of stock market activity [6].

Fig. 2 confirms the cubic law for the DJIA index.

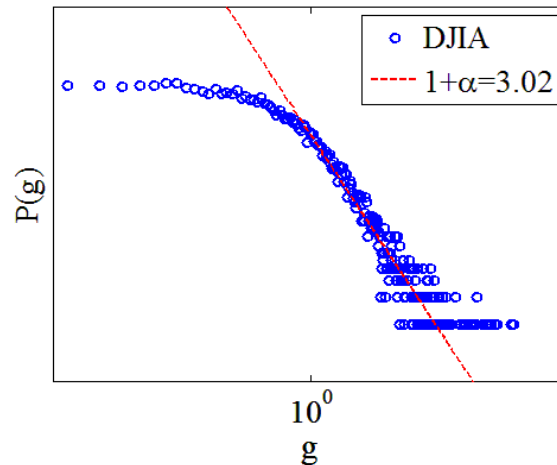

Fig. 2. Cumulative distributions of the normalized DJIA daily returns. Fits yield values $\alpha = 2.02 \pm 0.02$.

In the analysis of cotton prices, Mandelbrot observed that in addition to being non-Gaussian, the process of returns shows another interesting property: “time scaling” — that is, the distributions of returns for various choices of Δt , ranging from 1 day up to 1 month have similar functional forms [7]. Motivated by (i) pronounced tails, and (ii) a stable functional form for different time scales, Mandelbrot [7] proposed that the distribution of returns is consistent with a Levy stable distribution [8] — that is, the returns can be modeled as a Levy stable process. Levy stable distributions arise from the generalization of the Central Limit Theorem (CLT) to random variables which do not have a finite second moment.

The CLT [9], which offers the fundamental justification for approximate normality, points to the importance of α -stable distribution: they are the only limiting laws of normalized sums of independent, identically distributed random variables. Gaussian distributions, the best known member of the stable family, have long been well understood and widely used in all sorts of problems. However, they do not allow for large fluctuations and are thus inadequate for modeling high variability. Non-Gaussian stable models, on other hand, do not share such limitations. In general, the upper and lower tails of their distributions decreases like a power function. In literature, this is often characterized as heavy or long tails. In the last two or three decades, data which seem to fit the stable model has been collected in fields as diverse as economics, telecommunications, hydrology and physics (see for example [6]).

During our research of Levy’s stable distribution, applied for the stock market, we have found that there are many articles, which were devoted to it [4-6, 10-12]. Consequently, it was pointed out that Levy’s stable distribution fits better than the

Gaussian distribution to financial markets. It is still debatable whether Levy's stable distribution is appreciable, since there is not enough theoretical material and there is not a universal analyzing method for estimating parameters of Levy's stable distribution.

Therefore, during our research we discuss theoretical material applied to Levy's stable distribution, and discuss whether it acceptable for indicating crisis states on financial markets or not.

Our research structured as follows. Section 2 is introduction to Levy's stable distribution and its properties. Section 3 describes different approaches for estimating stable distribution parameters. In Section 4 we described how to estimate Levy's stable distribution and which method the most appreciable method for calculating its parameters. Section 5 present classified DJIA price data, and obtained results.

2 Levy's Stable Distribution Properties

Levy's stable distribution being the generalization of the CLT, became an addition to a wide class of distributions. Assume that $P_n \equiv \sum_{i=1}^n x_i$ is the sum of i.i.d. random variables x_i . Then, if the variables x_i have finite second moment, the CLT holds and P_n is distributed as a Gaussian in the limit $n \rightarrow \infty$.

In case when the random variables x_i are characterized by a distribution having asymptotic power-law behavior (3) P_n will converge to a Levy stable stochastic process of index α in the limit $n \rightarrow \infty$.

Stable distribution is presented by 4 parameters: $\alpha \in (0, 2]$ is the stability parameter, $\beta \in [-1, 1]$ the skewness parameter, $\gamma \in [0, \infty)$ the scale parameter and $\delta \in (-\infty, \infty)$ the location parameter. Since the variables x_i is characterized by four parameters, we will denote α -stable distribution by $S(\alpha, \beta, \gamma, \delta)$ and write

$$x \sim S(\alpha, \beta, \gamma, \delta) \quad (4)$$

Stable distribution has a property that the mean cannot be defined for $\alpha \in (0, 1]$ and the variance diverges for $\alpha \in (0, 2)$.

Furthermore, the Levy stable distributions cannot be defined in closed form for a few cases: the case of $(\alpha, \beta) = (2, 0)$ corresponds to the Gaussian distribution, $(\alpha, \beta) = (1, 0)$ to the Cauchy distribution. Instead, it is expressed in terms of their Fourier transforms or characteristic functions (CF), which we denote as $\lambda(k)$, where k denotes the Fourier transformed variable.

For Levy stable distribution, if the variable x_i follows $S(\alpha, \beta, \gamma, \delta)$, the CF can be expressed as [13]

$$\lambda(k) = \begin{cases} \exp\{i\delta k - |\gamma k|^\alpha [1 + i\beta \frac{k}{|k|} \text{tg}(\frac{\pi\alpha}{2})]\}, & (\alpha \neq 1) \\ \exp\{i\delta k - |\gamma k|^\alpha [1 + i\beta \frac{k}{|k|} \ln|k|]\}, & (\alpha = 1) \end{cases} \quad (5)$$

It worth considering that with value of $\beta = 0$, the distribution is symmetric, right-tailed if positive, and left-tailed if negative.

3 Methods for Estimation of Stable Law Parameters

There are numerous approaches which can estimate stable distribution parameters. Since the probability density functions is not always expressed in a closed form, there are some challenges to overcome the analytic difficulties. Thus, there have been constructed a variety of methods: the approximate maximum likelihood estimation [14, 15], quantiles method [16, 17], fractional lower order moment method [18, 19], method of log-cumulant [20], the logarithmic moment method [21] and more. Unfortunately, some of those methods cannot be applied due to computational problems associated with limited range of estimation, restricted range of parameters, high computational costs, or requiring large number of data. However, several of them should be mentioned.

3.1 Maximum Likelihood Method

DuMouchel was the first to obtain approximate ML estimates of α and γ (assuming $\delta = 0$) [22]. A multinomial approximation to the likelihood function is used in his approach. Under some additional assumptions on $\hat{\alpha}$ and the likelihood function, DuMouchel has shown the obtained estimates to be consistent and asymptotically normal. However, the computational effort involved seems considerable.

A direct method can be formulated, after Brorsen and Yang [14], as follows. The standard symmetric probability density functions defined by Zolotarev [23] is presented as

$$f_{\alpha}(x) = \frac{\alpha}{\pi|1-\alpha|} x^{1/(\alpha-1)} \int_0^{\pi/2} U_{\alpha}(\eta, 0) e^{-x^{\alpha/(\alpha-1)} U_{\alpha}(\eta, 0)} d\eta, \quad (6)$$

for $\alpha \neq 1, x > 0$, where U_{α} is defined by

$$U_{\alpha}(\eta, \eta_0) = \left(\frac{\sin \alpha(\eta - \eta_0)}{\cos \eta} \right)^{\alpha/(1-\alpha)} \frac{\cos(\eta - \alpha(\eta - \eta_0))}{\cos \eta}, \quad (7)$$

and η_0 is explained here [24]. Therefore, the parameters α, γ and δ can be estimated from the observations x_i ($i = 1, 2, \dots, n$) by maximizing the log likelihood function

$$\sum_{i=1}^n \log f_{\alpha}(z_i) = n \log \alpha - n \log(\alpha - 1) \pi + \sum_{i=1}^n \frac{\log z_i}{\alpha - 1} + \sum_{i=1}^n \log \int_0^{\pi/2} U_{\alpha}(\eta, 0) e^{-z_i^{\alpha/(\alpha-1)} U_{\alpha}(\eta, 0)} d\eta, \quad (8)$$

where $z_i = |x_i - \delta| / \gamma$.

To avoid the discontinuity and nondifferentiability of the symmetric α -stable density function at $\alpha = 1$, α is restricted to be greater than one. Caution must be used when evaluating the integrals (6) and (8), since the integrals are singular at $\eta = 0$.

An obvious disadvantage of this method is that it is a highly nonlinear optimization problem and no initialization and convergence analysis is available.

3.2 Sample Quantiles Methods

Let x_i be the f -th population *quantile*, so that $S(\alpha, \beta, \gamma, \delta)(x_i) = f$. Let \hat{x}_f be the corresponding *sample quantile*, i.e. \hat{x}_f satisfies $F_n(\hat{x}_f) = f$. As McCulloch [17] points out, to avoid spurious skewness in finite samples, a correction must be made. If the x_i 's are arranged in ascending order, the correction may be performed by identifying x_i with $\hat{x}_{q(i)}$, where $q(i) = \frac{2i-1}{2n}$, and then interpolating linearly to f from the two adjacent $q(i)$ values. Then \hat{x}_f is a consistent estimator of x_f , the f quantile.

3.3 Regression Method

Koutrouvelis [13, 25] presented a regression type method of estimating the four parameters of stable distribution. It is based on the following algorithm concerning the CF. From (5) it can be derived that

$$\log(-\log|\lambda(k)|^2) = \log(2\gamma^\alpha) + \alpha \log|k|. \quad (9)$$

The real and imaginary parts of $\lambda(k)$ are for $\alpha \neq 1$ given by

$$\lambda_R(k) = \exp(-|\gamma k|^\alpha) \cos \left[\delta k + |\gamma k|^\alpha \beta \text{sign}(t) \text{tg} \left(\frac{\pi\alpha}{2} \right) \right],$$

and

$$\lambda_I(k) = \exp(-|\gamma k|^\alpha) \sin \left[\delta k + |\gamma k|^\alpha \beta \text{sign}(t) \text{tg} \left(\frac{\pi\alpha}{2} \right) \right].$$

The last two equations lead, apart from considerations of principal values, to

$$\arctg \left(\frac{\lambda_I(k)}{\lambda_R(k)} \right) = \delta k + \beta \gamma^\alpha \text{tg} \left(\frac{\pi\alpha}{2} \right) \text{sign}(k) |k|^\alpha. \quad (10)$$

Equation (9) depends only on α and γ and suggests that we estimate these parameters by regressing

$$y = \log(-\log|\lambda_M(k)|^2)$$

on $\omega = \log|k|$ in the model

$$y_n = m + \alpha\omega_n + \varepsilon_n, n = 1, 2, \dots, N, \quad (11)$$

where (k_n) is an appropriate set of real numbers, $m = \log(2\gamma^\alpha)$, and ε_n responds for an error term.

With estimated and fixed parameters α and γ , the values of β and δ can be obtained by using equation (9). Let $g_n(u) = \text{Arctg}(\lambda_{I,n}/\lambda_{R,n})$, where Arctg denotes the principal value of the arctan function. Then we can estimate β and δ by regressing $z = g_n(u) + \pi\tau_n(u)$ on u and $\text{sign}(u)|u|^\alpha$ in the model

$$z_l = \delta u_l + \beta\gamma^\alpha \text{tg}\left(\frac{\pi\alpha}{2}\right) \text{sign}(u_l)|u_l|^\alpha + v_l, l = 1, \dots, L, \quad (12)$$

where (u_l) is an appropriate set of real numbers and v_l denotes an error term.

As it was mentioned before, most of these methods have high computational costs, restricted ranges of parameters or require a large number of data. Thus, we would like to use simple approach proposed by Koutrovelis [25] which is based on CF and it is tested to be valid and clears the above issues.

4 Estimation of Levy's Stable Distribution

When we analyze data, we often assume that they are *ergodic* [26]. In general, if random variables x_n ($n = 1, 2, \dots, N$) are ergodic with the integrable function $f(x)$, the preserving map $T(x)$ and the measure $p(x)dx$ in the space M , then the following equation holds [27]:

$$\lim_{N \rightarrow \infty} \frac{1}{N} \sum_{n=1}^N f(T^n x) = \int_M f(x) p(x) dx. \quad (13)$$

Then, to consider characteristic functions, equation (13) comes out to be the following ergodic equality [27]:

$$\lim_{N \rightarrow \infty} \frac{1}{N} \sum_{n=1}^N \exp(ikx_n) = \int_{-\infty}^{\infty} \exp(ikx) f(x) dx, \quad (14)$$

for which we have

$$\hat{\lambda}(k) = \lim_{N \rightarrow \infty} \frac{1}{N} \sum_{n=1}^N \exp(ikx_n). \quad (15)$$

This assumption allows us to empirically obtain the probability distribution. Hence, the empirical characteristic function $\lambda_N(k)$ of a large number of data set x_n ($n = 1, 2, \dots, N$) can be calculated as

$$\hat{\lambda}_N(k) = \frac{1}{N} \sum_{n=1}^N \exp(ikX_n). \quad (16)$$

When the data follow Levy's stable distribution with the parameters $(\alpha, \beta, \gamma, \delta)$ ($\alpha \neq 1$, $k > 0$), the characteristic function can be presented as

$$\hat{\lambda}_N(k) = \exp \left[i\delta k - (\gamma k)^\alpha \left\{ 1 + i\beta \tan \left(\frac{\pi\alpha}{2} \right) \right\} \right] \quad (17)$$

from equation (5). With equation (17), we can derive

$$\log(-\log |\hat{\lambda}_N(k)|) = \hat{\alpha} \log k + \hat{\alpha} \log \hat{\gamma} \quad (18)$$

and

$$\frac{1}{k} \operatorname{arctg} \left\{ \frac{\hat{\lambda}_{N,I}(k)}{\hat{\lambda}_{N,R}(k)} \right\} = -\hat{\beta} \hat{\gamma}^{\hat{\alpha}} \operatorname{tg} \left(\frac{\pi \hat{\alpha}}{2} \right) k^{\hat{\alpha}-1} + \hat{\delta}, \quad (19)$$

where each of $\hat{\lambda}_{N,I}(k)$ and $\hat{\lambda}_{N,R}(k)$ corresponds to the imaginary and real part of the empirical CF. Through linear regression method in equations (18) and (19) around $k = 0$ the parameters $(\alpha, \beta, \gamma, \delta)$ can be estimated. In case when (γ, δ) are far from the standard value of $(1, 0)$, each parameter can not be estimated accurately. In this case the data should be normalized to $(\gamma, \delta) = (1, 0)$ and then (α, β) can be estimated.

While the standard estimation method use the probability density function from the actual data with difficulty in estimating the tails of the distribution which are essentially important part of Levy's stable distribution, the method which we use in this paper can indicate the tail through the characteristic function. In addition, this method has a faster convergence according to the increasing number of data. The introduced integer $\tau_n(u)$ accounts for possible nonprincipal branches of the arctan function.

5 Data Classification of Dow Jones Industrial Average

In this paper we have estimated Levy's parameters for stock indices for the period from 1 March 2000 to 28 March 2019 daily values. This data include stock indices of developed countries, developing and emergent markets. The data were downloaded from Yahoo Finance (<http://finance.yahoo.com>) and Investing.com (<https://www.investing.com>). The distribution parameters were found for the entire time series and the algorithm of a moving window. For moving window, the part of the time series (window), for which there were calculated corresponding parameters, was selected. Then, the window was displaced along the time series in definite increment (step) and the procedure repeated until all the studied series had exhausted. For our case the window width is 500 and 1000 days, time step 1 and 5 days. The calculation results for the whole time series of the order-decreasing parameter α are shown in Table 1.

Table 1. The calculated Levy's stable parameters α and β for the considered stock indices. The results were obtained for the length of window 500 and time step 1 day.

N	Index	α	β
1	Nikkei 225	1.71	-0.240
2	IBEX 35	1.71	-0.206
3	CAC 40	1.70	-0.247
4	OMX Stockholm 30	1.70	-0.152
5	FTSE MIB	1.69	-0.374
6	Swiss Market Index	1.69	-0.210
7	DAX PERFORMANCE	1.68	-0.199
8	FTSE 100	1.68	-0.180
9	Warsaw Stock Exchange WIG	1.68	-0.022
10	BEL 20	1.67	-0.236
11	TA 35	1.67	-0.186
12	KOSPI Composite	1.66	-0.304
13	S&P/TSX Composite	1.60	-0.349
14	AEX	1.60	-0.214
15	BIST 100	1.60	-0.120
16	Dow Jones Industrial Average	1.59	-0.126
17	BOVESPA	1.58	-0.080
18	Hang Seng	1.58	-0.153
19	S&P 500	1.57	-0.151
20	IPC MEXICO	1.48	-0.118
21	NASDAQ Composite Index	1.48	-0.139
22	RTS Index	1.46	-0.081
23	BSE Sensex 30	1.44	-0.027
24	Nifty 50	1.42	-0.047
25	Jakarta Stock Exchange Composite	1.27	-0.043
26	Shanghai Composite	1.27	-0.046
27	KSE 100	1.05	-0.050
28	Ukraine PFTS	0.83	-0.089
29	S&P Merval	0.74	-0.055

The considered stock indices for the specified period include crisis phenomena and these periods obviously affect the dynamics of distribution parameters. Therefore, you should calculate them in the model of the moving window and compare their dynamics with the dynamics of the original time series.

For analysing and explaining basic characteristics of complex systems with α -stable distribution, we have chosen Dow Jones Industrial Average index (DJIA) as the most quoted financial barometer in the world. In addition, like complex systems, financial markets fascinating examples of complexity: a real world complex system whose evolution is dictated by the decisions of many people, generating huge amounts of data. For understanding of the falls that occurred on this market, we analysed different scientific articles [31-32], and relying on our research, we classified them on crashes and critical event, and separated DJIA time series into two parts where first part occupies period from 2 January 1920 to 3 January 1983 and second part from 4 January 1983 to 18 March 2019, for having better overview of its dynamics. Note that the data

set here is an every 1-day data, except those when stock market closed and does not work. During our research it was established that:

- Crashes are short, time-localized drops, with strong losing of price each day.
- Critical events are those falls that, during their existence, have not had such serious changes in price as crashes.

As it is seen from the Table 1, during DJIA existence, many crashes and critical events shook it. According to our classification, events with number (1, 10, 13, 15) are crashes, all the rest – critical events. From the data above, we estimate the parameters α and β of the stable distribution that the best describes the empirical returns.

Further, comparing the dynamics of the actual time series and the corresponding measures of complexity, we can judge the characteristic changes in the dynamics of the behavior of complexity with changes in the stock index. If the estimated parameter behaves in a definite way for all periods of crashes, for example, decreases or increases during the pre-critical period, then it can serve as an indicator-precursor of such a crashes phenomenon.

Table 2 shows the major crashes and critical events related to our classification.

Table 2. Major Historical Corrections since 1920.

N	Interval	Days in correction	Decline, %
1	03.09.1929-29.10.1929	41	39.64
2	01.03.1938-31.03.1938	23	24.15
3	08.04.1940-05.06.1940	42	25.10
4	21.08.1946-10.09.1946	14	16.35
5	30.07.1957-22.10.1957	60	17.51
6	19.03.1962-28.05.1962	50	19.91
7	18.07.1966-07.10.1966	59	12.84
8	09.04.1970-26.05.1970	34	20.35
9	24.10.1974-04.10.1974	52	27.45
10	02.10.1987-19.10.1987	12	34.16
11	17.07.1990-23.08.1990	28	17.21
12	01.10.1997-21.10.1997	15	12.43
13	17.08.1998-31.08.1998	11	18.44
14	14.08.2002-01.10.2002	34	19.52
15	16.10.2008-15.12.2008	42	30.21
16	09.08.2011-22.09.2011	32	11.94
17	18.08.2015-25.08.2015	6	10.53
18	29.12.2015-20.01.2016	16	11.02
19	03.12.2018-24.12.2018	15	15.62

From the figures below we can see that our parameters start to decrease in crisis states. Such abnormal behavior can serve as indicator or precursor of crashes and critical states.

For the first time, the use of dynamic indicators, precursors of crashes in stock markets using the parameters of a α -stable distribution, was proposed by us in the works [30, 31] and later repeated in a recent work [32]. Moreover, the authors [32], analyzing

only one crisis of 2008 and using a limited set of stock market indices (only three), conclude that the β parameter is an even more convincing indicator of the approaching crisis. Our data for a large set of critical events and crashes, as well as stock indices of countries of different levels of development convincingly speak in favor of the α parameter.

Interesting are the conclusions that follow from the analysis of Table 1. Indeed, the indexes of stock markets, ordered by the value of the α parameter, reveal a characteristic pattern that large α parameters correspond to more advanced stock markets of developed countries. At the same time, the β asymmetry parameter also differs markedly from zero. For emerging and emerging markets, the α parameter is noticeably smaller, and the β parameter tends to zero.

In our opinion, this indicates that crises in emerging markets occur more often, are more profound and long lasting. This leads to a decrease in the α parameter (see Fig. 3a, c) and leveling of the distribution asymmetry, with the result that the β tends to zero.

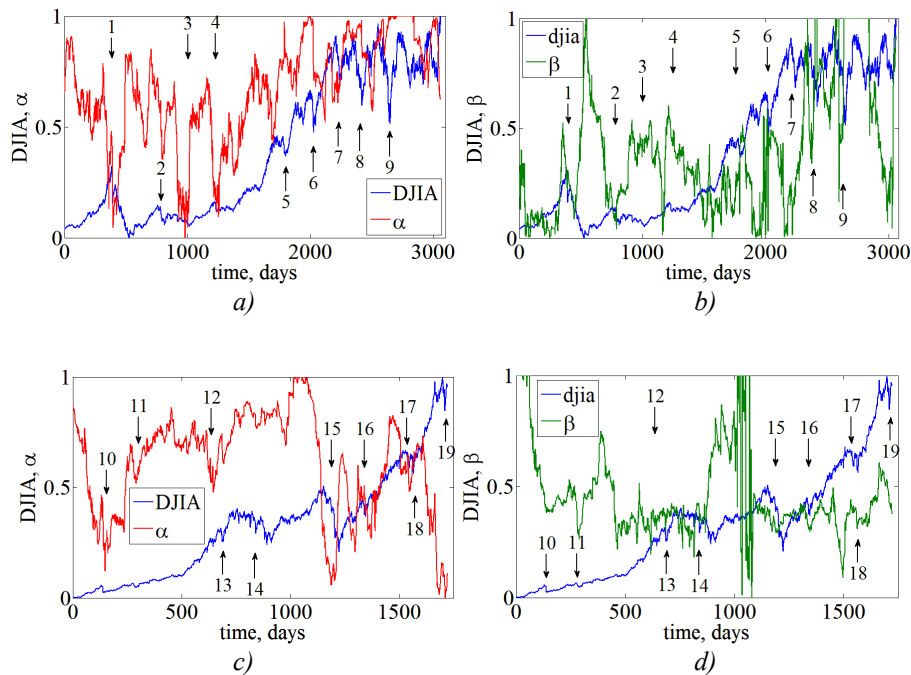

Fig. 3. The corresponding time series and estimated for them parameters α (a, c) and β (b, d). Vertical arrows indicate crashes and critical events.

6 Conclusions

Recently, there has been an increasing of interest in the study of quantitative methods for the stability of financial objects, especially in crisis situations. It is extremely important to take precisely preventive measures to prevent significant financial losses.

In this respect, an important role is played by the methods of constructing indicators of crisis phenomena, which warn in advance of a possible approaching crisis, that makes them as indicators-precursors of possible crisis states.

Crises manifest themselves in the form of strong price fluctuations of most assets and financial market instruments. In particular, stock market indexes exhibit increased volatility, which is reflected through the appearance of long tails in non-Gaussian probability density functions.

This paper has examined the behaviors of stock markets price fluctuations. As many others results, our research have demonstrated that the fluctuation distribution of DJIA index over the long period of 1900-2019 are characterized by heavy tails and can be described by the Levy's stable parameters. A similar pattern is observed for other stock indices taken over the shorter period from 2000 to 2019. Relating on theoretical background of Levy's stable distribution, stock markets time series and normalized log-returns for stock index price, it have been obtained that the Gaussian distribution for stock market is less suitable than Levy's stable distribution.

Further, we have discussed different method for the parameters estimation of the distribution, and pointed out which method is the best. Calculated parameters (α , β) have presented a similar behavior for different crisis states and proved that they can be used as indicators of crashes and critical periods. Moreover, it is shown that the absolute values of the distribution parameters themselves characterize the degree of development and efficiency of the stock market itself.

References

1. Podobnik, B., Valentinčić, A., Horvatić, D., Stanley, H.E.: Asymmetric Lévy flight in financial ratios. *Proceedings of the National Academy of Sciences of the United States of America*. **108**(44), 17883–17888 (2011). doi:10.1073/pnas.1113330108
2. Baruník, J., Vácha, L., Vošvrda, M.: Tail behavior of the Central European stock markets during the financial crisis. *AUCO Czech Economic Review*. **4**(3), 281–295 (2010)
3. Bachelier, L.: Théorie de la spéculation. *Annales scientifiques de l'École Normale Supérieure, Série 3*. **17**, 21–86 (1900). doi:10.24033/asens.476
4. Gopikrishnan, P., Plerou, V., Amaral, L.A.N., Meyer, M., Stanley, H.E.: Scaling of the distribution of fluctuations of financial market indices. *Physical Review E - Statistical Physics, Plasmas, Fluids, and Related Interdisciplinary Topics*. **60**(3), 5305–5316 (1999). doi:10.1103/PhysRevE.60.5305
5. Gabaix, X., Gopikrishnan, P., Plerou, V., Stanley, H.E.: A Theory of Power Law Distributions in Financial Market Fluctuations. *Nature*. **423**(6937), 267–270 (2003)
6. Gabaix, X., Gopikrishnan, P., Plerou, V., Stanley, H.E.: Institutional Investors and Stock Market Volatility. *Quarterly Journal of Economics*. **121**(2), 461–504 (2006). doi:10.3386/w11722
7. Mandelbrot, B.: The variation of certain speculative prices. *The Journal of Business*. **36**(4), 394–419 (1963). doi:10.1086/294632
8. Levy, P.: Théorie des erreurs. La loi de Gauss et les lois exceptionnelles. *Bulletin de la Société Mathématique de France*. **52**, 49–85 (1924)
9. Gnedenko, B.V., Kolmogorov, A.N.: *Limit Distributions for Sums of Independent Random Variables*. Addison-Wesley, Cambridge (1954)

10. Fama, E.F.: The Behavior of Stock-Market Prices. *The Journal of Business*. **38**(1), 34–105 (1965).
11. Mantegna, R.N., Stanley, H.E.: Scaling behaviour in the dynamics of an economic index. *Nature*. **376**, 46–49 (1995).
12. Weron, R.: Levy-stable distributions revisited: tail index > 2 does not exclude the Levy-stable regime. *International Journal of Modern Physics C*. **12**(2), 209–223 (2001).
13. Koutrouvelis, I.A.: Regression-Type Estimation of the Parameters of Stable Laws. *Journal of the American Statistical Association*. **75**(372), 918–928 (1980)
14. Brorsen, B.W., Yang, S.R.: Maximum Likelihood Estimates of Symmetric Stable Distribution Parameters. *Communications in Statistics - Simulation and Computation*. **19**(4), 1459–1464 (1990). doi:10.1080/03610919008812928
15. Nolan, J.P.: Maximum likelihood estimation of stable parameters. In: Barndorff-Nielsen, O.E., Mikosch, T., Resnick, S.I. (eds.) *Lévy Processes: Theory and Applications*, pp. 379–400. Springer Science+Business Media, Boston (2001)
16. Fama, E.F., Roll, R.: Parameter estimates for symmetric stable distributions. *Journal of the American Statistical Association*. **66**(334), 331–338 (1971). doi:10.2307/2283932
17. McCulloch, J.H.: Simple consistent estimators of stable distribution parameters. *Communications in Statistics - Simulation and Computation*. **15**(4), 1109–1136 (1986)
18. Shao, M., Nikias, C. L.: Signal processing with fractional lower order moments: stable processes and their application. *Proceedings of the IEEE*. **81**(7), 986–1010 (1993). doi:10.1109/5.231338
19. Ma, X., Nikias, C.L.: Joint estimation of time delay and frequency delay in impulsive noise using fractional lower order statistics. *IEEE Transactions on Signal Processing*. **43**(11), 2669–2687 (1996). doi:10.1109/78.542175
20. Nicolas, J.-M., Anfinson, S. N.: Introduction to second kind statistics: Application of log-moments and log-cumulants to the analysis of radar image distributions. *Traitement du Signal*. **19**(3), 139–167 (2002)
21. Kuruoğlu, E.E.: Density parameter estimation of skewed α -stable distributions. *IEEE Transactions on Signal Processing*. **49**(10), 2192–2201 (2001). doi:10.1109/78.950775
22. DuMouchel, W.H.: On the Asymptotic Normality of the Maximum Likelihood Estimate When Sampling from a Stable Distribution. *The Annals of Statistics* **1**(5), 948–957 (1973)
23. Zolotarev, V.M.: *One-dimensional Stable Distributions*. American Mathematical Society, Providence (1986)
24. Chambers, J.M., Mallows, C.L., Stuck, B.W.: A Method for Simulating Stable Random Variables. *Journal of the American Statistical Association*. **71**(354), 340–344 (1976).
25. Koutrouvelis, I.A.: An iterative procedure for the estimation of the parameters of stable laws: An iterative procedure for the estimation. *Communications in Statistics - Simulation and Computation*. **10**(1), 17–28 (1981). doi:10.1080/03610918108812189
26. Arnold, V.I., Avez, A.: *Ergodic problems of classical mechanics*. Benjamin, New York (1968). doi:zamm.19700500721
27. Umeno, K.: Ergodic transformations on \mathbb{R} preserving Cauchy laws. *Nonlinear Theory and Its Applications*. **7**(1), 14–20 (2016). doi:10.1587/nolta.7.14
28. Charles, A., Darné, O.: Large shocks in the volatility of the Dow Jones Industrial Average index: 1928–2013. *Journal of Banking & Finance*. **43**(C), 188–199 (2014). doi:10.1016/j.jbankfin.2014.03.022
29. Duarte, F.B., Tenreiro Machado, J.A., Monteiro Duarte, G.: Dynamics of the Dow Jones and the NASDAQ stock indexes. *Nonlinear Dynamics*. **61**(4), 691–705 (2010). doi:10.1007/s11071-010-9680-z

30. Soloviev, V.M., Chabanenko, D.M.: Dynamika parametriv modeli Levi dlia rozpodilu prybutkovostei chasovykh riadiv svitovykh fondovykh indeksiv (Dynamics of parameters of the Levy model for distribution of profitability of time series of world stock indexes). In: Pankratova, E.D. (ed.) Proceedings of 16-th International Conference on System Analysis and Information Technologies (SAIT 2014), Kyiv, Ukraine, May 26-30, 2014. ESC "IASA" NTUU "KPI", Kyiv (2014)
31. Soloviev, V., Solovieva, V., Chabanenko, D.: Dynamics of α -stable Levy process parameters for returns distribution of the financial time series. In: Chernyak, O.I., Zakharchenko, P.V. (eds.) Contemporary concepts of forecasting the development of complex socio-economic systems, pp. 257–264. FO-P Tkachuk O.V, Berdyansk (2014)
32. Fukunaga, T., Umeno, K.: Universal Lévy's stable law of stock market and its characterization. <https://arxiv.org/pdf/1709.06279> (2018). Accessed 21 Mar 2019
33. Bielinskyi, A., Semerikov, S., Solovieva, V., Soloviev, V.: Levy's stable distribution for stock crash detecting. SHS Web of Conferences. **65**, 06006 (2019). doi:10.1051/shsconf/20196506006

Digitalization as a Global Trend and Growth Factor of the Modern Economy

Olena Kravchenko^[0000-0002-9138-3988]

Bohdan Khmelnytsky National University of Cherkasy, 81, Shevchenko Blvd., Cherkasy,
18000, Ukraine

olena_kravchenko17@ukr.net

Maryna Leshchenko, Dariia Marushchak, Yuriy Vdovychenko

Cherkasy State Technological University, 460, Shevchenko Blvd., Cherkasy, 18000, Ukraine
mari.leshchenko@gmail.com, d.marushchak@chdtu.edu.ua,
yurockv@gmail.com

Abstract. The phenomenon of the digitalization in the world economy is investigated in the article. The digital economy is the most important engine of innovation, competitiveness and economic growth in the world. The specific features of the modern digital economy are determined. The main indicators of measuring the level of digital economy are analyzed, the world countries' leaders are defined. Study shows that each of the indexes has different methodological approaches to determining the level of digitalization and contains various factors. Highly developed countries have the best level of digitization of their own economies, because they have high-quality access to the Internet, a high level of scientific and technological capacity development and wide information access. The indicators of Ukraine as a digital economy are analyzed. Article shows that Ukraine as a European country is only at the beginning of its development of a high-quality digital economy. The links between national economy's macroeconomic indicators development connecting with innovations are established.

Keywords: digitalization, world economy, innovations, economic growth, indexes, technologies.

Today, economic growth is impossible without using of information and communication technologies, because they are covering increasingly various spheres of economic activities and creating new opportunities for socio-economic development. Globalization, transformation of consumer behavior, mobility, availability of information are the trends of our time. Digital technologies are radically reshaping the global economic system. The formation of an effective digital economy will open significant opportunities for the creation and development of business, it will help to increase investment flows, accumulation of human and financial resources of the world.

The concept of "digital economy" first appeared in 1995, as this year was previously defined as a turning point in the production of equipment for information technology.

Moreover, at that time Internet emerged as a significant source of “free” content [1, p. 2].

Throughout history, the economy has been transformed by revolutionary inventions (telegraph, railway, car). The difference with the Internet is that it is inherently global, used by both developed and developing countries. John Sviokla said “the Internet is one of the most complex things ever created. It takes human organization to another level. Thus, the digital economy will launch the third wave of capitalism, that will transform business and government and lead to the creation of extraordinary wealth around the world” [2, p. 6].

The universal term “the third industrial revolution” has gained great popularity, the main ideologues of which are the researchers Jeremy Rifkin [3] and Raymond Kurzweil [4], that provides for the gradual introduction of a whole complex of new technological solutions (including renewable / clean energy sources, composite and nanomaterials, biomedical innovations, 3D printing technologies, mass electrification of transport etc.) [3, 4].

The core of the digital economy is the "digital sector": the IT / ICT industry that produces fundamental digital goods and services. This “digital economy” is defined as “part of an economic outcome derived solely or primarily from digital technologies with a business model based on digital goods or services” – consists of the digital sector and also new digital and platform services. The increased use is the using of ICT in all sectors of the economy, this is the “digital economy” [5].

The development of the digital economy can generally be described as the process by which information technologies, such as the Internet or other means of communication, change economic and social relations in such a way that a number of barriers in international economic relations disappear altogether or minimize. In this context, it is worth mentioning the statement of T. Friedman, the essence of which is that new technologies have the ability to unite the world by forming their own strong links through a combination of production, research and marketing processes in different countries at the same time and maintain control over these processes through the latest means of communication [6]. Computerization covers all the tools that have led to the progress of society and its transition from industrial to information. It is worth remembering the concept of “information” society of D. Bell, when knowledge and information become the main, inexhaustible, renewable resource [7]. And the information itself is a public good and is characterized by all the properties that are inherent in them, namely, accessibility for a wide range of consumers and exceptional competitiveness. This is what ensures the rapid development of information resources, and they become at the same time the basis for the development of the modern digital economy.

The digital economy is growing rapidly on a global scale. It is the most important engine of innovation, competitiveness and economic growth in the world. The main products of the digital economy are the same goods and services of the traditional economy that is provided by computer equipment and digital systems such as the global Internet. This has its advantages, the main of which is to increase the availability of ordinary users to certain markets (goods or services), not only large companies, reduce transaction costs, increase efficiency and competitiveness.

The characteristic feature of the digital economy is its connection with the economy on demand (on-demand economy), which provides for not the sale of goods and services, but access to them at the moment when it is needed. The advantages of the economy on demand are: high speed of obtaining the necessary services or goods; reducing their cost for the end-user by reducing the number of intermediaries; simplifying the output of suppliers of goods and services to users [8, p. 14].

The review of the digital Agenda for Europe (DAE) [9] highlighted the impact of digital technologies on work and growth, noting that the Internet provides people with the opportunity to create and disseminate their ideas, creating new content, entrepreneurs and markets.

Modern tools for the study of the level of digitalization covers a variety of techniques. In particular, the main indices characterizing the world digitalization include: Digital Evolution Index, DiGiX, Networked Readiness Index, IMD World Competitiveness, DESI, Bloomberg Innovation Index and ICT Development Index. Each index has different methodological approaches to determining the level of digitalization and contains different factors that help to investigate. For example, the Digital Evolution Index shows how different countries are moving from the physical past to the digital future, and offers simple tools to determine which countries are the most ready for the transition, how quickly they are updated, and whether some are better located than some others. The Digital Evolution Index analyzes the main indicators that govern the digitization of the country: delivery conditions, demand conditions, institutional environment and innovation and change. To get an overview of the digital readiness and competitiveness of countries, the index divides these indicators into 12 components measured using a total amount of 108 indicators [10]. Networked Readiness Index is an indicator of the world economic forum, which characterizes the level of development of information and communication technologies in the world [11]. NRI consists of three components: the ICT environment proposed by a particular country or community, the readiness of key stakeholders (individuals, businesses and governments) to use ICT, and finally the use of ICT among these stakeholders. The DiGiX index is an index of digitization that evaluates the factors, behavior of agents and institutions that enable the country to fully use information and communication technology (ICT) to enhance competitiveness and well-being. It is a complex index that summarizes the corresponding figures in 100 countries. DiGiX consists of six main components: infrastructure, adoption of households, adoption of enterprises, costs, regulation and maintenance [12]. The index of digital economy and society (DESI) measures progress in EU countries in reference to the digital economy and society. It combines a set of relevant indicators of European digital policy [13]. The structure of the index consists of 5 main indices, containing subindexes, giving accurate knowledge about the level of digitalization, such as ICT connectivity, digital skills, indicators, use of the Internet, integration into digital technologies, indicators of development of the electronic environment.

IMD World Competitiveness Center creating the rating takes as a basis such indicators as knowledge, technology and the future readiness of countries to implement digital technologies [14].

In general, comparing the ratings of countries, according to different methods and

indicators, we can see that the TOP-10 countries in every ratings changes because the overall calculation of the digitalization of economy is carried out on different indicators (Table 1).

Table 1. The Top-10 economies on the level of digitalization in different indexes.

Place	Digital Evolution Index	IMD Digital Competitiveness	DiGix	DESI(EU)	Bloomberg Innovation Index	ICT Development Index	Networked Readiness Index
1	Norway	Singapore	Luxembourg	Denmark	South Korea	Iceland	Singapore
2	Sweden	Sweden	Great Britain	Finland	Sweden	Korea	Finland
3	Switzerland	USA	Hong Kong	Sweden	Singapore	Switzerland	Sweden
4	Denmark	Finland	USA	Netherlands	Germany	Denmark	Norway
5	Finland	Denmark	Netherlands	Luxembourg	Switzerland	USA	USA
6	Singapore	Netherlands	Japan	Belgium	Japan	Hong Kong	Netherlands
7	South Korea	Hong Kong	Singapore	Great Britain	Finland	Netherlands	Switzerland
8	Great Britain	Switzerland	Norway	Ireland	Denmark	Norway	Great Britain
9	Hong Kong	Canada	Finland	Romania	France	Luxembourg	Luxembourg
10	USA	Norway	Sweden	Bulgaria	Israel	Japan	Japan

Global trends of digitalization of the economy show that highly developed countries have the best level of digitization of their own economies because they are characterized by high-quality access to the Internet (broadband and mobile Internet), a high level of development of scientific and technological potential and wide information access. Among the regions of the world (World Bank), the largest number of Internet users are in Europe and Central Asia. Today, about 75% of the total population of Europe and Central Asia use the Internet. This indicator reaches 50% in other regions [15].

Among the member of the participating countries of the European Union, the best access indicators have such countries as Denmark, Germany, Luxembourg, Sweden and the UK. In General, it can be seen that another group of EU member have at least 60% of all households, this says about high level of automation and ease of life. Such countries as the Czech Republic, Latvia and Italy have less indicators.

An integral part of digital Commerce is e-Commerce, it simplifies the purchase and sale for both buyers and sellers. This reduces the chain from seller to buyer and it is easier to purchase. The 5 largest e-Commerce markets include:

1. China: \$ 672 billion, share of e-Commerce in total retail sales – 15.9%;
2. United States: \$ 340 billion, share of e-Commerce in total retail sales – 7.5%;
3. UK: \$ 99 billion, share of e-Commerce in total retail sales – 14.5%;

4. Japan: \$ 79 billion, share of e-Commerce in total retail sales – 5.4%;
5. Germany: \$ 73 billion, share of e-Commerce in total retail sales is 8.4% [16].

The global trend shows that the main means of payment are credit cards (Asia and North America), in second place is a digital payment system, this is a platform of electronic means that can be used in any calculations (Western Europe and China). Another popular method is debit cards (Africa).

The majority of online purchases were made from manufacturers located on the same continent: Europe (63.4%), the Pacific region of Asia (57.9%), Africa (55.5%), Latin America (54.6%) and North America (45.5%).

It is expected that retail sales of e-Commerce will rise to 4.058 trillion in 2020, which is 14.6% of the total retail spending in 2015.

The increase of the number and quality of telecommunications use also has a great impact on digitalization. Global telecommunications revenues had decreased by 4% between 2015 and 2016, falling by \$ 1.9 trillion.

Developing countries experienced complex annual growth rate of 6.6 % in telecommunications revenues between 2008 and 2016, while developed countries experienced a decline of -0.8% in the same period. Developing countries have 83% of the world's population, they receive only 39% of the world's income from telecommunications [17].

It is worth noting that the European Union presents many opportunities and challenges associated with the rapid development of the digital economy, the rapid growth of data flows, the dominance of the USA firms, security concerns and new business models in many sectors. The digital transformation of business and society in the EU represents a huge potential for Europe.

An important indicator characterizes the state of the digital economy in the EU are the indicators of entrepreneurship through the Internet. The activity of entrepreneurs through the Internet is an integral part of the modern world market trade. Internet activity does not only facilitate trade, but it also helps quickly to accumulate and mobilize revenues.

In the EU, between 2008 and 2016, the share of enterprises that used electronic turnover increased by 7%, and the volume of sales of enterprises, due to electronic sales, increased by 6 percentage points.

During 2016, 44% of large enterprises carried out electronic sales, which corresponds to 26% of the total turnover of this class. Similarly, 29% of medium-sized enterprises carried out electronic sales, which corresponds to 13% of the total turnover of this value. On the contrary, 18% of small enterprises engaged in electronic sales, and that is only 7% of the turnover of such enterprises [18].

Such countries as the Czech Republic (5.6%), Ireland (5.9%), Slovakia (6.6%) and the UK (4.7%) demonstrated the development of e-Commerce, which contributes of business development. In such EU member countries as Belgium (-2.9%), Luxembourg (-3.1%), Netherlands (-6%), Lithuania (-3%) and Portugal (-2.7%) negative indicators were observed [19].

Ukraine, as a European country, is only at the beginning of its path to creating a high-quality digital economy. Despite the fact that Ukrainian IT specialists are in great

demand on the world labor market, undeveloped infrastructure, “outdated technologies”, lack of legislation and the target direction in the government is a great obstacle for creating the necessary conditions of digitalization for the national economy.

Ukraine takes only the 85th place among the countries in the world in the World Economic Forum. According to the components Ukraine has the following positions: the number of Internet users – 80th place, Internet connection – 64th, Internet bandwidth – 68th place, mobile Internet connection – 131st. Unfortunately, Ukraine has worsened its ICT indicators of use for the last two components (Table 2).

Table 2. Ukraine’s position in the ranking of the world Economic Forum, 2016-2017 [20, 21].

Indicator	2016-2017		2015-2016	
	Place	Indicator	Place	Indicator
Technological development				
Technological adaptation (borrowing, perception)	85	3.6	86	3.45
Availability of the most modern technologies	93	4.3	96	4.3
Technological absorption of corporate level	74	4.4	100	4.2
FDI and technology transfer	115	3.7	117	3.8
The use of ICT				
Internet users	80	49.3	80	53.4
Broadband Internet connection	64	11.8	72	8.4
Bandwidth	68	45.7	64	40.7
Mobile broadband connection	130	8.1	121	7.5

In Bloomberg Innovation Index 2017 Ukraine has fallen to the 4th position for the year, taking forty-sixth place. Ukraine is ahead of Cyprus, South Africa, Iran and Morocco. It was on the 33rd place in 2015. In the Networked Readiness Index Ukraine occupies 64th place (Table 3).

Table 3. Ukraine in the world rankings of digitalization of the economy, 2017.

Index	Place	Index	Place
Networked Readiness Index	x	DESI (EU)	x
IMD Digital Competitiveness	85	Bloomberg Innovation Index	46
DiGix	87	ICT Development Index	79

Since Ukraine is not a member of the European Union, it is not possible to study its level in the DESI rating. Also, it is not possible to analyze its level in the Digital Evolution Index.

One of the main reasons is the lack of relevant indicators, this does not allow to study the level of digitalization and innovative development, and as a result to explore the real competitiveness of the state. It is also important to determine how the digitization of economic spheres affects the overall economic performance of the country. To do this, you can use the correlation, it means the connection, the relationship between objectively existing phenomena. Using correlation and regression analysis, we

construct a model of the relationship of GDP per capita (y) with factors that significantly affect the level of digitalization of the economy, namely fixed broadband subscription (x_1), individual use of the Internet (x_2), capital investment in software and databases (x_3), innovation in industrial enterprises (x_4), the total cost of innovation activities (x_5), technical grants (x_6), export of ICT services (x_7) – dependent variables. After constructing the correlation matrix, we obtained a value that provides information about the materiality of the relationship and the dependent variables and the resulting indicator and between the dependent variables (Table 4).

Table 4. The coefficients of pair regression.

	Fixed broad band subscription, x_1	Individual use of the Internet, x_2	Capital investment in software and databases, x_3	Implementation of innovations at enterprises, x_4	Costs of innovation activities, x_5	Technical grants, x_6	The export of ICT services, x_7	GDP per capita, y
Fixed broad band subscription, x_1	1							
Individual use of the Internet, x_2	0.992	1						
Capital investment in software and databases, x_3	0.463	0.441	1					
Implementation of innovations at enterprises, x_4	0.373	0.354	0.096	1				
Costs of innovation activities, x_5	0.761	0.736	0.525	0.154	1			
Technical grants, x_6	0.175	0.187	0.253	0.178	0.066	1		
The export of ICT services, x_7	0.947	0.945	0.464	0.517	0.707	0.107	1	
GDP per capita, y	0.671	0.657	0.336	-0.137	0.639	-0.168	0.556	1

Analyzing the value of the matrix of pair correlation coefficients, it can be confirmed that factors such as x_1 , x_2 , x_5 have a significant direct linear relationship with the resulting indicator ($r_{xy} > 0.65$). With regard to other factors, it can not be confirmed that the resulting indicator is uniquely linearly depends on them. As a result of testing of x -indicators for multicollinearity, we excluded from further research x_1 (fixed broadband subscription), x_2 (individual use of Internet) and x_7 (export of ICT services).

As a result we get regression equation:

$$y = 2942.037 + 0.04x_3 - 118.18x_4 + 0.14x_5 - 2.66x_6.$$

Calculate the coefficient of multiple correlation and determination:

$R_{xy} = 0.935154509$ – correlation between x_i and y is strong enough;

$d = 0.874513955$ – 87.4% of GDP per capita depends on the investigated factors, and other 12.6% of the factors were not investigated in the model.

Check the model adequacy using the F -criteria: $F_{\text{calculated}}=41.814$ when $F_{\text{tabular}}=3.55$, as $F_{\text{calculated}}>F_{\text{tabular}}$, so this means the model is adequate in terms of statistical data.

Having determined the elasticity coefficients, we can say that the elasticity coefficient with a value of 0.08482325 indicates that if capital investments in software and databases (x_3) will grow by 1%, then GDP per capita (y) will increase by 8.5%. If the introduction of innovations in industrial enterprises (x_4) grow by 1%, the GDP per capita (y) will decrease by 75%. If the total amount of costs in the areas of innovation (x_5) grow by 1%, the GDP per capita (y) will increase by 51.6%. If technical grants (x_6) grow by 1%, GDP per capita (y) will decrease by 30.6%.

Thus, the digital revolution develops network communications over the administrative borders of countries and territories, which accelerates the transition of the world to a decentralized, distributed model of production. In the future, the development of ICT can reduce the cost of international logistics, as well as stimulate the development of offshoring.

According to empirical researches conducted by McKinsey Global Institute, digitalization of the economy can be no less powerful tool to improve its productivity and competitiveness than creating technological innovations [22].

This means that all countries, and especially those that have embarked on the path of catching-up development, have a chance for a rapid breakthrough in productivity growth if they focus on the broad informatization of society and the effective implementation in business process of already existing ICT in the world, but not only on the creation of their own breakthrough technologies in certain directions.

References

1. Jorgenson, D.W.: Information technology and the U.S. economy. *Am. Econ. Rev.* **91**(1), 1–32 (2001)
2. The new digital economy. How it will transform business. http://www.citibank.com/transactionservices/home/docs/the_new_digital_economy.pdf (2011). Accessed 10 Jan 2019
3. Rifkin, J.: *The third industrial revolution: how lateral power is transforming energy, the economy, and the world*. Palgrave Macmillan, New York (2011)
4. Kurzweil, R.: The law of accelerating returns. <http://www.kurzweilai.net/the-law-of-accelerating-returns%E> (2001). Accessed 5 Dec 2018
5. Ivanova, V.V.: Informatsiyni rynek: zarubizhni i ukrainski realii (Information market: foreign and Ukrainian realities). *Actual problems of economics*. 2, 39–43 (2009)
6. Friedman, T.: *Lexus și măslinul. Cum să înțelegem globalizarea*. Editura Fundației PRO, București (2001)
7. Bell, D.: *The coming of post-industrial society. A venture in social forecasting*. Basic Books, New York (2001)
8. Karcheva, G., Ogorodnya, D., Openko, V.: Tsyfrova ekonomika ta yii vplyv na rozvytok natsionalnoi ta mizhnarodnoi ekonomiky (Digital economy and its impact on the development of the national economy). <https://fp.cibs.ubs.edu.ua/files/1703/17kgttme.pdf> (2017). Accessed 24 Jan 2019

9. Fact Sheets on the European Union: Digital Agenda for Europe. <http://www.europarl.europa.eu/factsheets/en/sheet/64/digital-agenda-for-europe> (2019). Accessed 20 Jan 2019
10. Digital Planet 2017: How Competitiveness and Trust in Digital Economies Vary Across the World. <https://sites.tufts.edu/digitalplanet/dei17> (2017). Accessed 17 Dec 2018
11. Networked Readiness Index. Global Information Technology Report. <http://reports.weforum.org/global-information-technology-report-2016/networked-readiness-index> (2016). Accessed 05 Dec 2018
12. Cámara, N., Tuesta, D.: DiGiX: The Digitization Index. https://www.bbvaesearch.com/wp-content/uploads/2017/02/WP_17-03_DiGiX_methodology.pdf (2017). Accessed 15 Dec 2018
13. DESI 2018. Digital Economy and Society Index. Methodological note. http://ec.europa.eu/information_society/newsroom/image/document/2018-20/desi-2018-methodology_E886EDCA-B32A-AEFB-07F5911DE975477B_52297.pdf (2018). Accessed 07 Feb 2019
14. IMD World Digital Competitiveness Ranking 2017. <https://data.worldbank.org> (2017). Accessed 08 Jan 2019
15. World bank open data. <https://data.worldbank.org> (2017). Accessed 02 Feb 2019
16. Global Ecommerce Platforms 2017: A Country-by-Country Review of the Top Retail Ecommerce Sites. eMarketer Report (2017)
17. World Telecommunication/ICT Indicators Database. https://www.itu-ilibrary.org/science-and-technology/data/world-telecommunication-ict-indicators-database_pub_series/database/2a8478f7-en (2017). Accessed 21 Mar 2019
18. Digital Economy and Society Index. Methodological note, <http://ec.europa.eu/eurostat/data/database> (2017). Accessed 02 Dec 2018
19. Eurostat/European Commission. <https://ec.europa.eu/eurostat/data/database> (2018) . Accessed 21 Mar 2019
20. Schwab, K.: World Economic Forum: The Global Competitiveness Report 2016-2017. http://www3.weforum.org/docs/GCR2016-2017/05FullReport/TheGlobalCompetitivenessReport2016-2017_FINAL.pdf (2017). Accessed 18 Nov 2018
21. Schwab, K.: World Economic Forum: The Global Competitiveness Report 2015-2016. http://www3.weforum.org/docs/gcr/2015-2016/Global_Competitiveness_Report_2015-2016.pdf (2016). Accessed 25 Dec 2018
22. Manyika, J., Lund, S., Bughin, J., Woetzel, J., Stamenov, K., Dhingra, D.: Digital globalization: The new era of global flows. <https://www.mckinsey.com/~/media/McKinsey/Business%20Functions/McKinsey%20Digital/Our%20Insights/Digital%20globalization%20The%20new%20era%20of%20global%20flows/MGI-Digital-globalization-Full-report.ashx> (2016). Accessed 07 Feb 2019
23. Kravchenko, O., Leshchenko, M., Marushchak, D., Vdovychenko, Y., Boguslavska, S.: The digitalization as a global trend and growth factor of the modern economy. SHS Web of Conferences. **65**, 07004 (2019). doi:10.1051/shsconf/20196507004
24. Semerikov, S., Soloviev, V., Kibalnyk, L., Chernyak O., Danylchuk, H.: M3E2 2019 - Towards a new economy in the public interest. SHS Web of Conferences. **65**, 00001 (2019). doi:10.1051/shsconf/20196500001
25. Derbentsev, V.D., Serdyuk, O.A., Solovyov, V.M. and Sharapov, O.D.: Synergetic and econophysics methods for the study of dynamic and structural characteristics of economic systems. Brama-Ukraine, Cherkasy (2010)
26. Soloviev, V., Belinskiy, A.: CCIS. **1007**, 276 (2019)

27. Soloviev, V., Solovieva, V., Solovieva, K.: Comparative analysis of the dynamics of the stock market of Ukraine using fractal measures of complexity. *Bulletin of Cherkasy University. Series of Economic Sciences.* 33, 246 (2012)

Modeling of Financial Support for the Competitiveness of Employees in the Mining Industry

Iryna Perevozova^[0000-0002-3878-802X], Nadiia Daliak^[0000-0002-1599-842X]

Ivano-Frankovsk National Technical University of Oil and Gas, 1, Chopin Str., Ivano-Frankivsk, 76000, Ukraine
perevozova@ukr.net, nadiya_d82@ukr.net

Vitalina Babenko^[0000-0002-4816-4579]

V. N. Karazin Kharkiv National University, 4, Freedom Sq., Kharkiv, 61022, Ukraine
vitalinababenko@karazin.ua

Abstract. The development of a socially oriented market economy in Ukraine, the effective implementation of reforms in this direction and the improvement of the well-being of the population is not possible without qualitative financial support for the competitiveness of workers, above all, in the mining industry. However, the absence of effective levers of influence on the organization of high-tech production in this area, its considerable intensiveness of material and energy, and its complexity and harm have negatively affected the labor motivation of miners and the profitability of mining enterprises. Therefore, the urgent issues at the current stage of development of Ukraine's mining industry are determining the conditions and opportunities for increasing the competitiveness of employees in this industry. Scientific novelty of the results is to identify, substantiate and analyze the main stages of financial support for the competitiveness of workers in the mining industry under the conditions of a changing vector of the country's foreign economic policy and of market for products of this industry. The obtained results of the research are the basis to both the study and practical solution of the problem of how to increase the competitiveness of miners in enterprises under various forms of management. This approach involves not only a high level of material incentives for highly qualified specialists in mining, but also a comprehensive development of personnel potential in this industry as a whole.

Keywords: employee, mining industry, mining company, personnel management.

1 Introduction

The formation of high-tech production in Ukraine, effective implementation of reforms to this end, increase in gross domestic product and real incomes of citizens is only possible under the condition of high-quality financial support for the competitiveness of workers, above all, in the mining industry. However the lack of an effective program for the development of this industry and inhibition of its socio-economic reforms has

negatively affected the attitude towards the work by miners and the quality of development of the mining industry as a whole. Thus, in 2014-2015, the number of registered unemployed in this industry exceeded other sectors in Ukraine by 4 times. At the same time, the profitability of operational activity of industrial companies in Ukraine for the above period decreased more than twice and amounted to less than 1% [1]. This situation destabilizes the industrial and economic security of the country, as well as the supply and demand of the labor market in this field.

Taking into account urgency and lack of solution for the aforementioned problem, the main *goal* of this *study* is to characterize financial support for the competitiveness of the mining industry workers and to develop measures for its improvement. To achieve this goal, we have identified the *following main tasks*:

- to form an apparatus of categories on the interpretation of the essence of the workers' competitiveness in the mining industry;
- to identify and characterize the main stages of financial support for the competitiveness of workers in this field;
- to propose measures for the effective implementation of the above-mentioned stages.

2 Theory of the Matter

The abovementioned matter has been researched by such scientists as: A. Cardoso [2], T. Chan, M. Egorova [3], P. Fedotov, E. Zelynskaya [4], G. Gayko, V. Beletsky [5], V. Ivanov, V. Komarov, P. Pavlov [6], S. Kozlov [7], S. Mahdevari, K. Shahriar, A. Esfahanipour [8], J. Maiti, S. Chatterjee, S. Bangdiwala [9], *Y. Mossakovskyy* [10], *V. Nagornyy*, *V. Globa* [11], L. Polishchuk [12], J. Prno [13], J. Ryfkyn [14] and so on. Thus, scientists have identified the basic principles for the development of mining and recreation of its labor resources. However, the problem of a complex appraisal of the competitiveness of miners under the conditions of a changing vector of foreign economic policy of the country and the market for products of this sector has not been researched sufficiently.

3 Methodology of the Study

The methodological basis of this study is a general scientific dialectical method of cognition, in which the object of the study is studied as a dynamic system in the process of development. Formation of an apparatus of categories of competitiveness of workers in the mining industry and the main stages of its financial support, carried out on the basis of dialectical, historical and systemic methods. In the process of studying and generalizing scientific and practical developments, methods of comparison, analysis and synthesis, induction and deduction have been applied. Additionally, the study is based on regulatory and economic documents, developments by research institutions and scientists.

Mining industry is one of the most traumatic, especially in underground work, where there is significant gas pollution and dust. Scientists at the University of Michigan [15]

developed a model for assessing the individual cost of an employee, based on the notions of conditional and realized value.

The individual value of an employee depends on the expected probability that the employee will remain working and realizes his potential. That is, the realized cost of an employee:

$$RV = UV * P(T), \quad (1)$$

where UV is the employee's standard cost, $P(T)$ – the probability that the employee works at the enterprise until the end of his working age T , taking into account the level of risks of the industry.

The conditional cost of a UV employee characterizes all the potential profits an employee can bring to an organization if he has all the rest of his life working in it. Expected realized cost of an employee RV characterizes the value of an employee, given the likelihood that he will remain in the organization for some time. The RV poster is two-component: it consists of two elements: the expected conditional value of UV and the probability of continuing membership in the organization $P(T)$. The last figure is the expectation of management about what part of the revenues will be realized in the organization to the expected time of dismissal of the employee. The mathematical model of these processes has the form:

$$P(Z)=1-P(T); \quad (2)$$

$$AVP = UV - RV = RV * P(Z),$$

where UV and RV are expected conditional and realized costs;

$P(T)$ – the probability that the employee will remain in the organization after some time;

$P(Z)$ – the probability of dismissal of the employee from the organization or the rate of flow;

AVP – alternative flow rates.

In this model, the cost of human resources is probabilistic. For organization, this may mean that not always the employee with the greatest potential will be the most useful company. And the HR manager, who seeks to optimize the cost of human resources, should prefer a candidate with the highest realized value, and not just the most capable.

For the measurement of the monetary form UV and RV developed stochastic positional model. It is implemented by such an algorithm:

1. the creation of a base of mutually exclusive positions or positions that can be occupied by an employee in the organization, that is, the formation of a career path of the employee – a sequential chain of positions or service statuses with the addition of such a state as the release from the enterprise;
2. determining the value of each position for the organization, that is, the profit that will be brought in the future by the employee while on this position. Moreover, the profit can be attributed to the person of the employee, and to the position that he occupies, as in the case of personal and positional restorative costs;

3. determining the expectation of the term of human rights in the organization, that is, the assessment of the overall life of the person. It is influenced by many factors: individual expectations, the emotional and physical condition of the employee, the policy of the company in the area of staff recruitment and remuneration, mobility in the labor market, etc. All these factors are difficult to determine and measure, therefore, we can estimate the life of a person only from some probability. And, speaking of the expected life expectancy, we will have in mind the mathematical expectation of magnitude. There are two main ways of finding it: the method of expert evaluation and analytical;
4. the calculation of the probability that the employee will occupy each of the items specified in item 1 at a certain point in the future. To do this, on the basis of probabilistic assessments describe the expected career path of the employee up to release: with which probability each of the next year to the year of expected release from the organization employee will occupy each of the possible positions. In the last year of work the probability of dismissal should be equal to 100%. This probability can be measured by two methods described in the third step. An analytical method involves three consecutive steps: collection of data on hiring, moving and dismissal; grouping data according to official status; compilation of matrices of probability of transitions;
5. discounting the expected future cash income to determine the present value.

The proposed model of employee valuation also describes the dependence of the cost of human resources on the degree of satisfaction. Therefore, satisfaction must be measured and communicated to the management of the organization.

In the absence of the necessary statistical information for the characterization and assessment of the competitiveness of the mining industry, in 2017 we have conducted a sociological survey in 1256 employees of mining industry Donetsk, Luhansk, Zaporizhia, Kharkiv, Dnipropetrovsk, Lviv, Volyn and Transcarpathia regions of Ukraine. Using a questionnaire developed by the author, their opinion on the level of competitiveness of workers in the mining industry has been studied.

Preliminarily, we had formed a set of basic features and characteristics that reflect various professional and socio-psychological features of miners and form their competitiveness in the labor market. The main ones are: *gender, age, state of health, marital status and family composition, education, professional qualification level, work experience, conditions and work remuneration, computer skills, responsibility, and others*. Respondents were asked to evaluate each of these criteria, based on their importance, and to express it in a ballistic assessment on a scale from 1 (minimum) to 50 (maximum) points. The survey was participated in by: heads of enterprises (20%), heads of their structural divisions and leading specialists (30%), and ordinary workers (50%). Meaning, such groups of respondents, whose work is directly related to the definition and implementation of financial support for increasing the competitiveness in the mining industry, and those who are direct participants (performers) of individual production and technological processes.

4 Discussion of Results

As a result of the analysis, we have established that there are different approaches to the interpretation of the essence of the competitiveness of workers in the mining industry. They are similar to each other and differ only in separate constituents. Thus, *within this category* most scholars understand the ability of a specialist to fully realize his right to work in the economic entity of the mining industry and receive appropriate remuneration for it [2; 4-6; 8; 12-13].

Taking into account the interpretation of the socio-economic category described above, we have identified the main stages of financial support for the competitiveness of the mining industry (Fig. 1).

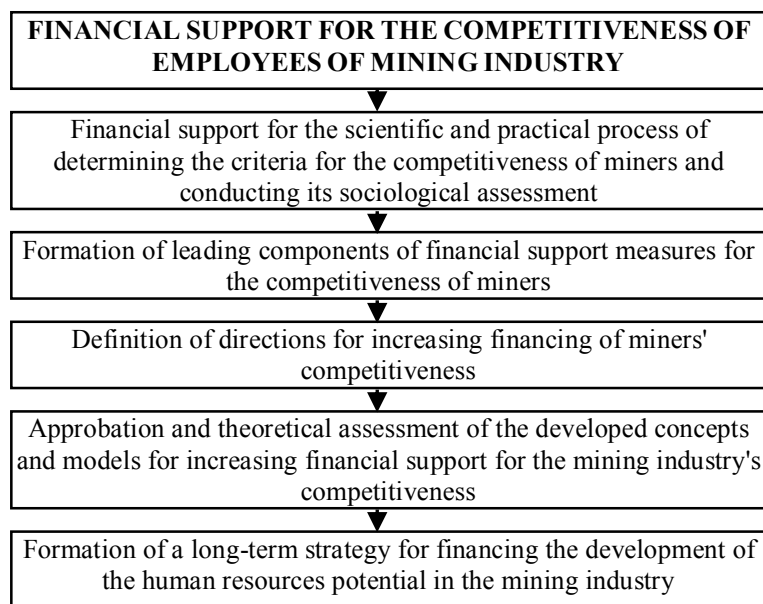

Fig. 1. Main stages of financial support for the competitiveness of mining workers

We believe that the proposed comprehensive methodological approach towards financial support for the competitiveness of mining workers will help identify its most important components and develop effective measures for their improvement.

In our opinion, the most significant of the above components is *the financial support of the scientific and practical processes of determining the criteria for the competitiveness of miners and conducting its sociological assessment*. Thus, appropriate funding allowed us to conduct monographic surveys to determine the main features and characteristics of the competitiveness of miners (Table 1).

Thus, the results of the above-mentioned sociological assessment of managers and employees of mining companies are different. Most managers and their deputies have set rather high requirements for the qualitative parameters of financial controllers and

their work activities, namely: professional qualification level, work experience, gender, sense of responsibility, lack of bad habits, health status, family status and composition. This is evidenced by the high average mark – 41.8 and the level of compliance with all the maximum possible parameters – 83.6%.

Table 1. Assessment of the main features and characteristics of the competitiveness of the mining industry enterprises of Donetsk, Lugansk, Zaporizhzhya, Kharkiv, Dnipropetrovsk, Lviv, Volyn and Zakarpattia Regions, points.

Feature, characteristic	Managers and their deputies	Hired workers	Average
Requirements for conditions and remuneration	20	50	35.0
Education	30	20	25.0
Professional qualification level	50	30	40.0
Experience	50	20	35.0
Gender	50	10	30.0
Age	30	20	25.0
Sense of responsibility	50	30	40.0
Lack of bad habits	50	35	42.5
Computer skills	40	35	37.5
Health status	50	50	50.0
Family status, composition	40	30	35.0
Average points of feature, characteristic	41.8	30.0	35.9
Compliance with all possible parameters, %	83.6	60.0	71.8

A more detailed analysis of the requirements of managers and their deputies contributed to identifying the priorities of this group of respondents regarding the requirements towards the applicant most appropriate for the position, whom they would prefer to employ in mining companies. In their opinion, this should be a male person, aged 18-40, with a professional qualification corresponding to the workplace, with or without work experience for this position for at least 5 years (for simple, unskilled and predominantly manual labor), who is responsible for fulfilling their duties and does not have bad habits (alcoholism, drug addiction, smoking). Thus, these qualities were evaluated by the respondents mentioned above with the maximum number of points. At the same time, heads of companies and structural units would like the applicant for the position have appropriate education and computer skills.

However, the requirements of hired workers of mining companies for competitiveness are much lower than those of managers and their deputies. For miners employed in non-executive positions, the following features are among the priorities for competitiveness: production conditions and value of labor are expressed by the level of remuneration, health status, age, marital status and family composition, etc. (average 30).

We believe that this situation reflects the relationship between the complexity of the work performed and the qualifications of its direct performers. As a result, differentiated requirements of employers and employees towards the characteristics of competitiveness of the latter are formed. So, if the work is predominantly typical,

manual, or mechanized, but involves material liability, then it requires, first of all, greater physical effort. Therefore, the requirements are higher for health, conditions and wages, and much less for the skills of work with computers, gender, education, etc. However, in real life, hired workers may not always meet the criteria of employers, which adversely affects the level of their competitiveness, because it depends on the influence of many factors.

In order to avoid disparity between the preferences of the above-mentioned respondent groups, it is necessary, in our opinion, to *formulate leading components of the financial support for the competitiveness of the mining industry and determine the ways to increase the financing of the competitiveness of miners* (Table 2). That means, the most important components and directions for financing to improve the competitiveness of miners are based on the implementation of measures for the preservation of human resources and their development in the short and long term. Thus, this approach envisages, above all, the following measures: financing of competitions concerning employment of miners according to clear criteria; financing of professional training and professional development of miners; financing of complex programs for employment, career growth and personnel rotation of specialists of all levels; financing of complex programs for the formation of the personnel reserve of miners according to their professional qualification and professional direction, etc.

Table 2. Leading components and directions for increasing the financial support of the competitiveness of mining workers in certain regions of Ukraine at macro and micro levels

No.	Component, direction	Macro level	Micro level
<i>Funding of competitions for miners' employment according to clear criteria</i>			
1.	Financing of leading scientific and practical specialists for the development and implementation of specific and relevant criteria for the selection and employment of miners.	-	+
<i>Financing of professional training and professional development of miners</i>			
2.	Financing of higher and vocational education by prospective specialists of the mining industry according to the needs of the labor market	+	+
3.	Financing of competitive projects to attract the most capable and active youth to work in the mining industry.	+	+
<i>Financing of complex programs for employment, career growth and personnel rotation of specialists of all levels</i>			
4.	Material incentives for miners working efficiently and effectively, taking into account their organizational and professional abilities, including prospect of their career growth.	-	+
<i>Financing of complex programs for the formation of a personnel reserve of miners according to their professional qualification and professional direction</i>			
5.	Material incentives for the most promising future and current young specialists in every work direction within the mining industry, promotion of their professional development, improvement of their professional and organizational skills and abilities and the possible assignment of each of them to the position at any time	-	+

In our opinion, the aforementioned approach will be conducive to the differentiation at the macro and micro levels of influence levers on employment, income, employment, conditions and attitudes towards labor and competitiveness under the market conditions of future and current professionals in the mining industry.

Additionally, the effectiveness of the implementation of all the above measures depends on the *approbation and the theoretical assessment of the developed concepts and models for increasing financial support measures for the competitiveness of the mining industry*. This approach involves the implementation of certain interrelated stages (Fig. 2).

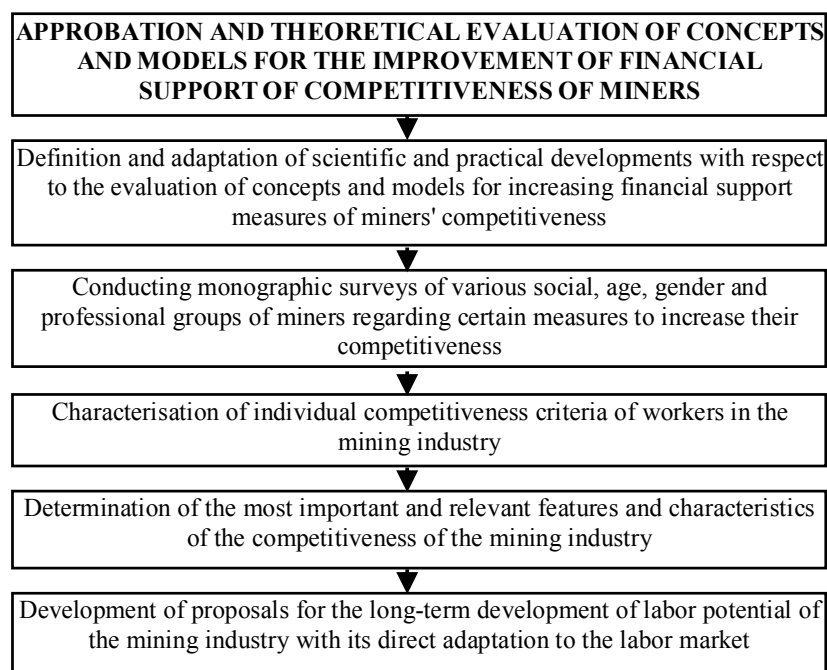

Fig. 2. The main stages of testing and theoretical assessment of concepts and models for increasing of financial support measures for the competitiveness of mining workers

Thus, the aforementioned approach involves a profound elaboration of theoretical concepts regarding the financing of human resources development in the mining industry and their effective practical implementation. At the same time, their application should help identify the most important components for improving the competitiveness of miners who need to improve, or to identify and finance the development of new ones.

In our opinion, *the formation of a long-term strategy for financing the development of human resources capacity of the mining industry is an equally important stage in providing financial support towards miners' competitiveness*. Thus, it should ensure the

implementation of the following measures at the expense of public and private institutions at the macro and micro levels:

- financing the development and implementation of a comprehensive state program of employment of depressed regions and unprofitable sectors of the economy (identification of priority areas for training, and retraining of future and current workers in the mining industry);
- financing of the employment system by the state or private mining companies (with partially jobs guaranteed by the state) (allocation of state funds for employment of the population in the relevant economic entities);
- financing and formation of a state order for the training of future mining specialists, taking into account the state and prospects of the labor market in this area (reduction of ineffective state expenditures for the training of specialists for which there is no demand in the labor market and directing these funds towards support of employment and increase of incomes of mining employees);
- financing the improvement of qualification of miners in modern domestic and foreign technologically equipped enterprises, institutions and organizations (competitive selection of the best experts in the mining industry and payment of their internships in the respective economic entities);
- financing of the system of re-training of workers in the mining industry in relation to this field (related to this field may be any specialisation related to work in heavy industry and the processing industry);
- financing a program of employment of disabled people with occupational diseases obtained as a result of work in this area (preferential taxation of economic entities employing this category of population);
- privileged income taxation for employees of unprofitable mining companies (granting of tax privileges on personal income, a single social contribution, value added tax, corporate income tax, etc.), etc.

We believe that all the above measures will not only increase the competitiveness of the miners, but will also contribute to their effective employment in this area and the improvement of welfare in general. They can also be used *as proposals for the effective implementation of financial support measures for the competitiveness of mining workers.*

5 Conclusion

Thus, as a result of the analysis, we have established that the competitiveness of an employee of the mining industry implies his ability to fully exercise his right to work in an economic entity of the industry and receive an appropriate remuneration for it at any time.

Taking into account the aforementioned interpretation, we have identified the main stages of the financial provision of the competitiveness of the mining industry. They foresee: financial support of the scientific and practical process of determining the criteria for competitiveness of miners and conducting its sociological assessment;

formation of the leading components of financial support for the competitiveness of workers in the mining industry; definition of directions for increasing financing of miners' competitiveness; approbation and theoretical assessment of the developed concepts and models of increasing the financial support measures of the mining industry's competitiveness; formation of a long-term strategy for financing the development of the human resources potential of the mining industry.

However, as a result of the monographic survey, we have established that there is a significant disparity between individual groups of respondents regarding the implementation of the above-mentioned stages. Thus, the activities of the heads of the mining enterprises and their deputies are aimed at minimizing the costs of human resources, while hired workers prefer to secure their own welfare at the expense of employers.

In order to avoid the above disparity, we have identified measures to increase the competitiveness of miners. They provide financial support for the implementation of professionally oriented personnel policies by employers for hired workers, periodically assessing the quality of work of each miner and providing them with appropriate material and socio-psychological incentives.

The above-mentioned approach will promote a higher level of competitiveness, employment and income of miners, as well as complex development of human resources potential of enterprises of the mining industry as a whole.

Further scientific research will examine the results of the application of the described stochastic positional model and the complex methodological approach to financial support for the competitiveness of mining workers at enterprises and substantiated the use of recommendations for the formation of a long-term strategy, including the application of preferential taxation of profits for workers of non-profit mining companies.

References

1. Statistical Yearbook of Ukraine for 2015. Government service of statistics of Ukraine, Kiev (2016)
2. Cardoso, A.: Behind the life cycle of coal: Socio-environmental liabilities of coal mining in Cesar, Colombia. *Ecological Economics*. 120, 71–82 (2015)
3. Chan, T.H.: Basic concepts economy forges production. Products of mineral-resource complex. Natural and productive potential. *Molodoj uchenuj*. 11.4, 229–232 (2015)
4. Fedotova, N.V., Fedotov, P.K., Zelynskaya, E.V.: Economics and Management mining production. Academia Estestvoznanyya, Moscow (2017)
5. Gayko, G.I., Beletsky, V.S.: History of Mining. Kievo-Mogylyanska academia, LADO, DonDTU, Kiev-Alchevsk (2013)
6. Ivanov, V.V., Komarov, V.M., Pavlov, P.N.: Questions of modernization: the role of social capital. Delo RANXyGS, Moscow (2014)
7. Kozlov, S.S.: Lecture on discipline – Occupational safety in the mining industry to prepare students of the Institute for Energy and Energy Efficiency qualification level “specialist” and “master”. NTUU KPI, Kiev (2013)

8. Mahdevari, S., Shahriar, K., Esfahanipour, A.: Human health and safety risks management in underground coal mines using fuzzy TOPSIS. *Science of the Total Environment*. 488, 85–99 (2014)
9. Maiti, J., Chatterjee, S., Bangdiwala, S.: Determinants of work injuries in mines – an application of structural equation modeling. *Injury control and safety promotion*. **11**(1), 29–37 (2004)
10. Mossakovskyy, Y.V.: *Economy mining industry: a textbook is for higher educational*. Gornaya knyga, Moscow (2014)
11. Nagornuy, V.P., Globa, V.M.: *Mining. The road length in millennium*. Akadempriodyka, Kiev (2014)
12. Polishchuk, L.I.: *Or severally report. Social capital cities in development*. Strelka Press, Moscow (2014)
13. Prno, J.: An analysis of factors leading to the establishment of a social licence to operate in the mining industry. *Resources Policy*. **38**(4), 577–590 (2013)
14. Ryfkyn, J.: *Financial capital against social capital Third Revolution: How horizontal interaction change Energy, economy and the world in general*. Alpina non-fiction, Moscow (2014)
15. Dobrenkov, V.I. (ed.): *American sociological thought*. MSU, Moscow (1994)
16. Perevozova, I., Babenko, V., Kondur, O., Krykhovetska, Z., Daliak, N.: Financial support for the competitiveness of employees in the mining industry. *SHS Web of Conferences*. **65**, 01001 (2019). doi:10.1051/shsconf/20196501001

Fractal Analysis of the Economic Sustainability of Industrial Enterprise

Andriy Matviychuk¹[000-0002-8911-5677], Oleksandr Novoseletskyy²[0000-0003-3757-0552], Serhii Vashchaiev¹, Halyna Velykoivanenko¹[0000-0001-6326-3965] and Igor Zubenko²

¹ Kyiv National Economic University named after Vadym Hetman, 54/1, Peremogy Ave., Kyiv, 03680, Ukraine

editor@nfmte.com, dean.fisit@kneu.edu.ua, ivanenko@kneu.edu.ua

² National university of Ostroh academy, 2, Seminarska Str., Ostroh, 35800, Ukraine
oleksandr.novoseletskyy@oa.edu.ua, admin@oa.edu.ua

Abstract. The article deals with the method of calculating the fractal analysis, the time series of economic sustainability of the industrial enterprise on the trend-resistant sustainability were investigated by estimating the depth of the long-term memory of the time series and constructing a phase portrait. According to the approach used, the “depth of the long memory” is estimated in terms of fuzzy sets. The approach to the estimation of the index of economic stability is developed, based on the methods of forming an integrated indicator consisting of an assessment of such subsystems as the industrial and technical, financial-economic and subsystem of main parameters of the market environment. These helps to estimate the economic stability of the enterprise in the conditions of incomplete information from purpose of making effective management decisions. Combination of techniques for the formation of an integral index and a fractal analysis of the assessment of its trend stability showed an effective result, which was confirmed by the experiments.

Keywords: economic sustainability, R/S-analysis, trend stability, time series, quasicycle, fuzzy set.

1 Introduction

Industrial enterprises in a modern economy are often characterized by nonlinear behaviour. It is necessary to solve the problem of identification and rapid response of the financial and production system of the enterprise to the influence of destabilizing factors. One of the directions of the solution of this problem is the use of a system of economic and mathematical models of evaluation and taking into account the economic stability of the enterprise, which will allow to diagnose the current state of the economic system (from the standpoint of dynamics and taking into account the risk) and timely use mechanisms that return the system to equilibrium. It is necessary to estimate the level of economic stability from the position of dynamics using the tools of nonlinear dynamics and fractal analysis. Based on these methods, the Hurst index and the level of long-term memory of the time series are calculated, as well as its trend-stability is

established. So, the purpose of research is investigation of economic sustainability of an enterprise by analysing the stability of the trends of its time series using the tools of fractal analysis.

2 Study Summary

The method of sequential R/S analysis is presented in [1]. The basis of this technique is a fractal analysis of time series. Let's consider it in more detail using the notation of the time series $Z_\tau = z_1, z_2, \dots, z_\tau, \tau = 3, 4, \dots, n$, for each of which the current average is calculated $\bar{z}_\tau = \frac{1}{\tau} \sum_{i=1}^{\tau} z_i$. Next for each $Z_\tau, \tau = 3, 4, \dots, n$, we calculate the accumulated deviation for segments of its length τ : $X_{\tau,t} = \sum_{i=1}^t (z_i - \bar{z}_\tau), t = \overline{1, \tau}$. After that we calculate the difference between the maximum and minimum accumulated deviations $R = R(\tau) = \max_{1 \leq t \leq \tau} (X_{\tau,t}) - \min_{1 \leq t \leq \tau} (X_{\tau,t})$, which is called "range R ". The next step is to rate R/S by adjusting it to a standard deviation of the time series segment $Z_\tau, 3 \leq \tau \leq n$ [2].

The Hurst index $H = H(\tau)$ is determined from the equation $R/S = (\alpha \cdot \tau)^H$. Logarithmizing both parts of this equation and assuming, respectively [1], that $\alpha = 1/2$, we obtain the values of Cartesian coordinates $(x_\tau; y_\tau)$ of points in H -path, the ordinate of which

$$y_\tau = \frac{\log(R(\tau)/S(\tau))}{\log(\tau/2)}, \quad (1)$$

and abscissa

$$x_\tau = \log(\tau), \quad \tau = 3, 4, \dots, n. \quad (2)$$

The output of the algorithm of R/S -analysis is also R/S -trajectory, represented in logarithmic coordinates by a sequence of points, abscissa in which $x_\tau = \log(\tau)$, and ordinate $y_\tau = \log(R(\tau)/S(\tau))$. By connecting the neighbouring points with a segment $(x_\tau; y_\tau)$ and $(x_{\tau+1}; y_{\tau+1}), \tau = 3, 4, \dots, n-1$, we obtain graphic mapping of the R/S -trajectory in the logarithmic coordinates.

The initial stage of the fractal analysis of the time series $Z = Z(z_i), i = \overline{1, n}$ is the formation of the family $S(Z) = \{Z^r\}, r = 1, 2, \dots, m$. The time series of this family is obtained by extracting the element z_1^{r-1} in the series Z^{r-1} . The level of the index r , which reaches the maximum value at the point of trend change in its R/S -trajectory, determines the value of m . The output timeline is assigned a zero value of the r index [1].

Let's consider the essence of economic sustainability as a system characteristic of an industrial enterprise [3], the time series of which we will examine.

Economic sustainability reflects the ability of the system to maintain an equilibrium state during its operation, to freely manoeuvre with technologies, resources, etc. in the event of the effect of destabilizing external and internal factors, adapt and fulfil the

stated purpose in conditions of permissible level of risk for further effective development. That is, the quantitative indicators of the assessment of the level of stability should characterize the economic status of the industrial enterprise, as well as reflect the possibilities and nature of its further development.

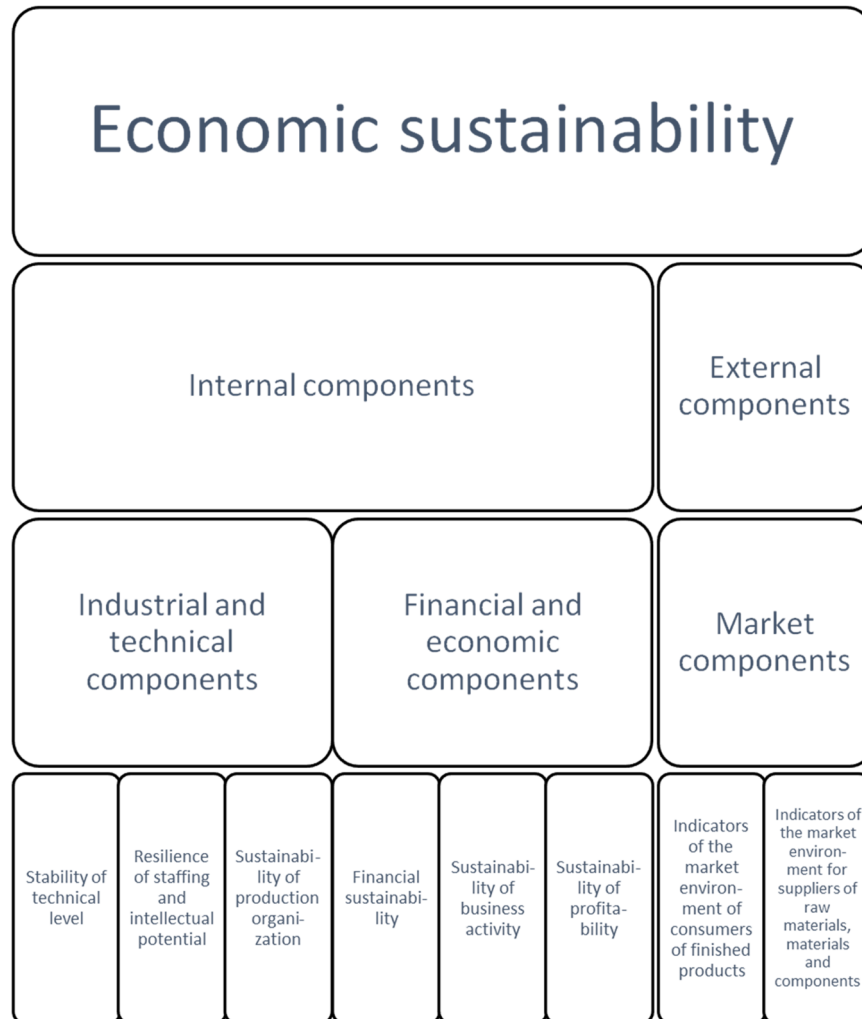

Fig. 1. Dominant hierarchy of estimation of economic stability of the enterprise.

The hierarchy analysis method involves decomposing the problem into separate components, ensuring its structuring and simplification with the construction of hierarchies containing different criteria. The relative advantage of various quantitative and qualitative detailed criteria is determined separately for each indicator of the

hierarchical structure from the point of view of the element, which is directly at the highest level of the hierarchy.

Using the hierarchy analysis method an algorithm for assessing the economic sustainability of an enterprise will consist of the following steps:

Step 1. Formation of a multilevel hierarchical structure, containing an integrated index of economic stability at the upper level, on the following - partial criteria, etc. at the lowest level of the hierarchy there are detailed indicators. We propose to highlight the next indicators:

- indicators that characterize the industrial and technical component of enterprise sustainability \tilde{S}_1 . This is the ratio of the residual value of fixed assets in the currency of the enterprise balance sheet, the coefficient of depreciation of fixed assets, the coefficient of renewal of fixed assets, the coefficient of labour output and return on assets, etc. The choice of these indicators is due to the fact that they allow you to see the level of material, personnel and intellectual potential and the industrial and technical state of the enterprise.
- indicators that characterize the financial and economic component of enterprise sustainability \tilde{S}_2 . These indicators include: coefficient of equity concentration, independence coefficient (autonomy), rapid liquidity ratio, coefficient of manoeuvrability of equity, ratio of own and borrowed funds, coefficient of turnover of equity capital, turnover ratio of material working capital, asset mobility coefficient, return on equity, sales and profitability of the core business. The choice of these indicators in the aggregate is due to the fact that they reflect the financial status, the state of business activity and profitability of the enterprise;
- indicators characterizing the market environment \tilde{S}_3 . This is the coefficient of firm sustainability in the consumer market and in the supplier market. Their choice was due to the fact that the position of the company in these markets determines its economic status.

Step 2. Construction of matrices of pairwise comparisons of elements of the hierarchical structure, which are at each level of the hierarchy (in addition to the integrated one) in terms of the criterion of a directly higher level.

Step 3. Calculation of the vector of weight coefficients of the detailed indicators of the level of stability of the enterprise, located at the lowest level of the hierarchical structure. That is, the quantitative values of the weight coefficients of the detailed indicators are calculated and their rationing is carried out. The obtained indicators k_i , $i = 1, \dots, n$ must satisfy, in particular, the condition $\sum_{i=1}^n k_i = 1$, $k_i \geq 0$, $i = \overline{1, n}$.

Step 4. Calculation of the integral index of economic sustainability. To calculate the quantitative assessment of the level of economic stability use the following formula of the integral indicator:

$$S_C = \sum_{m=1}^n \alpha_m \tilde{S}_m, \quad (3)$$

$$\sum_{m=1}^n \alpha_m = 1, 0 \leq \alpha_m \leq 1, m = \overline{1, n}.$$

The normalized value of partial criteria for economic sustainability of the enterprise \tilde{S}_m includes industrial and technical components \tilde{S}_1 , financial and economic components \tilde{S}_2 and market environment \tilde{S}_3 [4].

The sustainability level of each subsystem of the economic system including the specific gravity of each of the selected detailed indicators (criteria) \tilde{K}_i calculated as follows

$$S_m = -1 + \prod_{i=1}^n (1 + \tilde{K}_i)^{k_i}, \quad m = 1, \dots, 3, \quad \sum_{i=1}^n k_i = 1. \quad (4)$$

The calculated indicators S_m should be normalized \tilde{S}_m .

Step 5. Determination of the dynamics of the level of economic sustainability and the nature of the development of the economy of the industrial enterprise. To do this, we will use instrumentation of nonlinear dynamics, namely, non-linear models of R/S -analysis to determine the Hurst index, the availability of long-term memory and the assessment of its depth, as well as trend stability, which will characterize the importance of economic sustainability of the enterprise for several periods of its further functioning.

In Figures 2-4 there are presented the graphical representations of the time series of index of economic sustainability of the industrial enterprise PJSC Consumers-Sklo-Zorya (Ukraine) [5] and the fragment of the R/S - and H -trajectories obtained as a result of the application of the R/S -analysis algorithm to this time series.

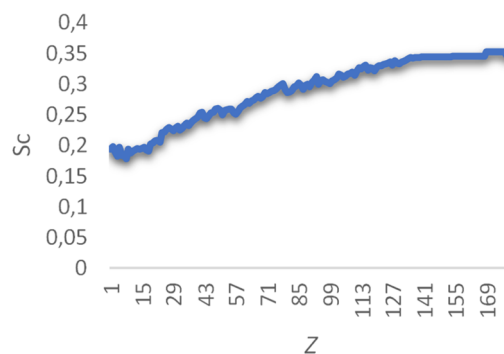

Fig. 2. The time series of index of economic sustainability.

The Fig. 4 shows us that the point $\tau = 4$ is in the area of white noise and at this point there is a breakdown to the black noise area (the value of $H(5)=0.66$), which allows preliminary estimate the depth of the memory in this area of the studied time series Z_4 by number 4. Changing the trend of the R/S -trajectory at the point $\tau = 4$, followed by the transition of the H -trajectory into the black noise zone, allows us to estimate the depth of long-term memory by the number 4. The initial time-series of sustainability has a weak trend-resistance. However, further the series is trend-resistant, which is confirmed by its presence in the vicinity of black noise.

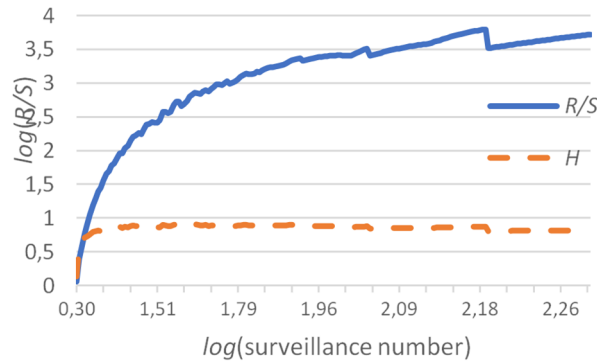

Fig. 3. *R/S*- and *H*-trajectories of the time series of economic sustainability of enterprise.

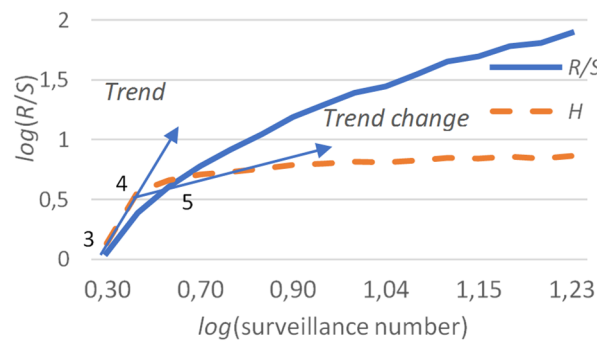

Fig. 4. A fragment of the *R/S*- and *H*-trajectories for time series of economic sustainability of enterprise.

Time series of the economic system are not random variables in pure form, the distribution of which probability is subject to a uniform, normal or other known law. Such series have a memory effect and they are called persistent or trend-resistant [6]. Preservation of the trend (probable) for the short-term period may be due to an increase (decrease) in such a series for a limited period. The specified trend stability in some sense is the opposite of short-term “Markov” memory, and we are talking about a time series with memory, in which older events have a tangible impact.

We propose to use the algorithm [7] for estimating the “depth of long-term memory” of the whole time series of economic sustainability and presenting it in the form of a fuzzy set consisting of next steps:

Step 1. Formation on the basis of the time series of index of economic sustainability of the enterprise of Z family $S(Z) = \{Z^r\}$, $Z^r = \langle z_i^r \rangle$, $i = 1, 2, \dots, n_r$, $r = 1, 2, \dots, m$, consisting of m time series Z^r , where by the index i are marked elements of a r -series obtained from the $(r - 1)$ time series Z^{r-1} by removing its first element z_1^{r-1} . Here m is defined as the largest value of the index r such that the series $Z^m = \langle z_i^m \rangle$, $i = 1, 2, \dots, n_m$ still have a point of trend substitution in its *R/S*-trajectory; the output Z -series also belongs to the family $S(Z)$, in which it is assigned the index value $r = 1$.

Step 2. It is carried out a consistent R/S -analysis of time series of economic stability of the family $S(Z)$. The result of the second step is to transform data to form a fuzzy set of values of the depth of memory of the time series.

Let for each time series $Z^r = (z_i^r)$, $i = 1, 2, \dots, n_r$, $r = \overline{1, m}$, as a result of applying to it a sequential R/S -analysis algorithm, built R/S -trajectory and H -trajectory, which determine the number of the point l_r , in which the trend was changed, that is l_r the number $i = l_r$ of the first point, which is “higher” than the white noise area, in which the H -trajectory received a negative gain, and the R/S -trajectory changed the trend.

Enter the following notation: $N(l)$ – the number of all the time series stability Z^r of the family $S(Z)$, each with a point number of the trend change l_r is equal to the number l ; $l^0 = \min_{1 \leq r \leq m} l_r$; $L^0 = \max_{1 \leq r \leq m} l_r$; $m = \sum_{l=l^0}^{L^0} N(l)$; $d(l) = \frac{N(l)}{m}$ – the result of such series in the family $S(Z)$, each with loss of memory occurred at a depth of l ; $L(Z) = \{l\}$ – the range of point numbers trend change in the ranks of the family $S(Z)$; $L(Z) = \{l, \mu(l)\}$, $l \in L(Z)$ – fuzzy set “depth of memory” [8, 9] for a time series Z as a whole, $\mu(l)$ – membership function to the “depth l ” of the fuzzy set $L(Z)$. Values $\mu(l)$ are proportional to the numbers $d(l)$, $l \in L(Z)$, at the output of step 2 they are obtained by a special normalization of the values of shares $d(l)$ so that $\mu(l) < 1$ for any $l \in L(Z)$.

For the time series of index of economic sustainability Z of the industrial enterprise PJSC Consumers-Sklo-Zorya [5], the result of calculations of fuzzy sets of depth of memory of time series is presented in Table 1.

Table 1. Intermediate results of calculations of fuzzy sets of depth of memory of time series Z .

l	$N(l)$	$d(l)$	$\mu(l)$
4	9	0.06	0.18
5	15	0.10	0.30
6	35	0.23	0.69
7	44	0.29	0.87
8	19	0.12	0.38
9	18	0.12	0.36
10	9	0.06	0.23
11	8	0.05	0.21

The values of the elements $\mu(l)$ of the last line are calculated as follows. First, they found the maximum share $d(l^*) = \max_{l \in L(Z)} d(l)$ (in Table 1 value $d^* = 0.29$) and its corresponding depth l^* ($d^*(l) = l^*$, value $l^* = 7$). Next, for this depth l^* the meaning of the membership function $\mu^* = \mu(l^*)$ was expertly identified. Then for the remaining items $l \in L(Z)$ the corresponding value were calculated by the formula $\mu(l) = \frac{d(l)}{d(l^*)} \cdot \mu(l^*)$.

Step 3. By way of pairwise union of elements $N(l)$ and $\mu(l)$, it is formed the fuzzy set of “depths of memory” of the time series of economic stability in general. In our case, it is:

$$M(Z) = \left\{ (4; 0.18), (5; 0.30), (6; 0.69), (7; 0.87), \right. \\ \left. (8; 0.38), (9; 0.36), (10; 0.23), (11; 0.16) \right\}. \quad (5)$$

For clarity, Fig. 5 shows a graphical representation of the depths of memory time series economic sustainability of the enterprise.

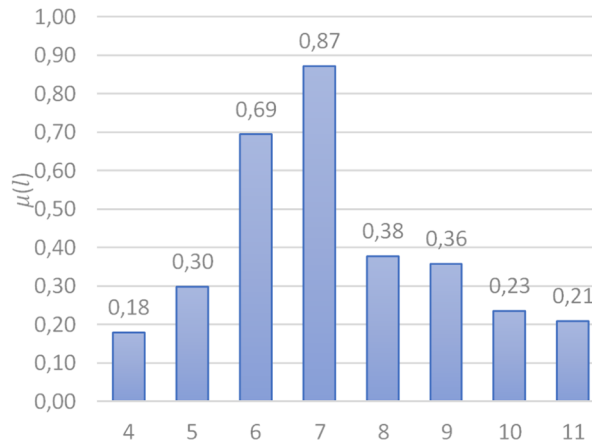

Fig. 5. A graphical representation of a fuzzy set memory depth time series of economic sustainability.

The result obtained indicates that the memory depth of a particular time series is not a fixed number; its value varies along the studied time series, that is, for each of its segments it is different. For example, as can be seen from Table 1, for the time series of economic sustainability numerical values of depth memory ranges on a segment of a natural 4, 5, ..., 11.

Detection of the depth of long-term memory should serve as ground for constructing a predictive model, which may consider all the essential factors that determine the presence of this memory. In the context of the prediction problem, it is useful to note the basic position of the decomposition analysis [10] of time series. In accordance with this provision, in the general case, the time series can be divided into 4 components: trend, cyclic component, seasonal variation and irregular or final component. In this case, the cyclic component, if it exists, can be a carrier of sufficiently valuable information to make a forecast. In an arsenal of modern methods of prediction of time series, such an approach as visualizing their phase portraits becomes of great importance.

As you know, when you build a phase portrait for a particular time series is fundamentally important question about its dimension ρ . This dimension must be no less than the dimension of the attractor of the studied series. In turn, the dimension of the attractor can be estimated with a fairly acceptable accuracy by using the fractal dimension. The latter is calculated by the formula $C = 2 - H$. Since for the time series considered in this paper the value is given $H \in (0; 1)$, we obtain an estimate $C < 2$. Thus, for our purposes, there are reasons to use a phase space $F(Z)$ of dimension $\rho = 2$ [1].

Such a phase trajectory of the time series of economic sustainability is presented in Fig. 6.

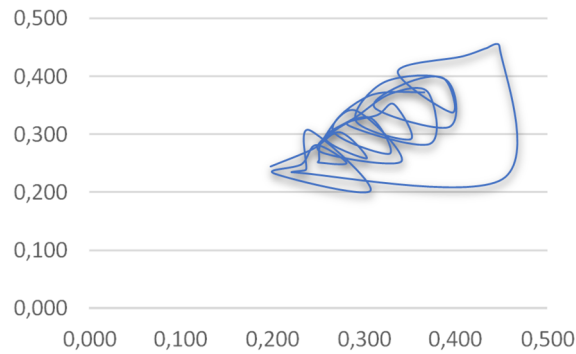

Fig. 6. A phase portrait of a time series in a two-dimensional phase space.

For its construction we used calculated data from Table 2.

Table 2. Output for abscissa and ordinates.

Period	Indicator value z_i	Indicator value z_{i+1}	Period	Indicator value z_i	Indicator value z_{i+1}
1	0.198	0.244	25	0.448	0.451
2	0.244	0.274	26	0.451	0.222
3	0.274	0.303	27	0.222	0.234
4	0.303	0.258	28	0.234	0.237
5	0.258	0.292	29	0.237	0.240
6	0.292	0.330	30	0.240	0.307
7	0.330	0.370	31	0.307	0.202
8	0.370	0.372	32	0.202	0.232
9	0.372	0.283	33	0.232	0.248
10	0.283	0.315	34	0.248	0.281
11	0.315	0.333	35	0.281	0.250
12	0.333	0.351	36	0.250	0.251
13	0.351	0.291	37	0.251	0.255
14	0.291	0.323	38	0.255	0.290
15	0.323	0.390	39	0.290	0.341
16	0.390	0.393	40	0.341	0.253
17	0.393	0.312	41	0.253	0.269
18	0.312	0.345	42	0.269	0.307
19	0.345	0.387	43	0.307	0.328
20	0.387	0.396	44	0.328	0.266
21	0.396	0.337	45	0.266	0.306
22	0.337	0.408	46	0.306	0.366
23	0.408	0.434	47	0.366	0.372
24	0.434	0.448	48	0.372	

Consider this phase portrait in the form of a trajectory, namely, in the form of a sequence of points in which each adjacent pair is connected by a segment or curve. In this trajectory we also select its segments, which are called quasicycles [11]. The definition of quasicycle is close to the concept of a cycle. The difference between these two concepts is that the initial and final quasicycle points do not have to match. The end point of a quasicycle is determined by its occurrence in the baseline of the initial point, while self-propelling the initial and final links of the quasicycle is allowed, if this leads to a maximum approximation of the initial and final points. In reality there are such series of economic processes in which phase portraits contain such pairs of non-neighbouring time points, in which the coordinates in the phase space actually coincide. The presence of such pairs of points actually destroys the cyclic structure of phase trajectories.

So, overall, the trajectory of the phase portrait (Fig. 6) the time series of economic stability consists of eleventh quasicycles C_r , $r = 1, \dots, 11$. Fig. 7-10 shows some fragments of these quasicycles.

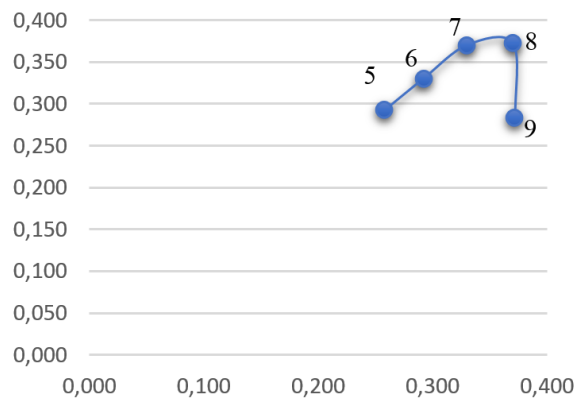

Fig. 7. The second quasicycle of the output timeline Z.

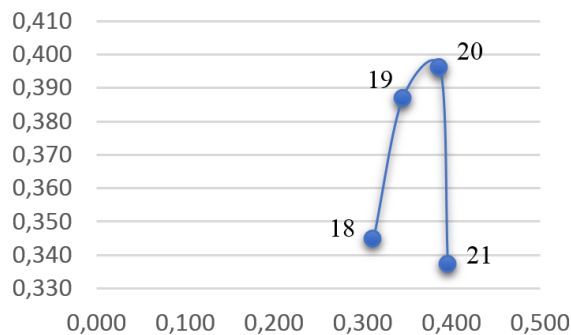

Fig. 8. The fifth quasicycle of the output timeline Z.

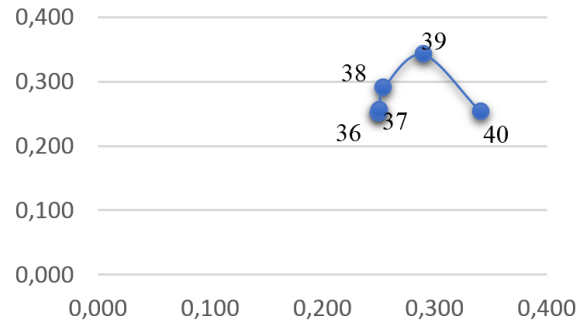

Fig. 9. The ninth quasicycle of the output timeline Z .

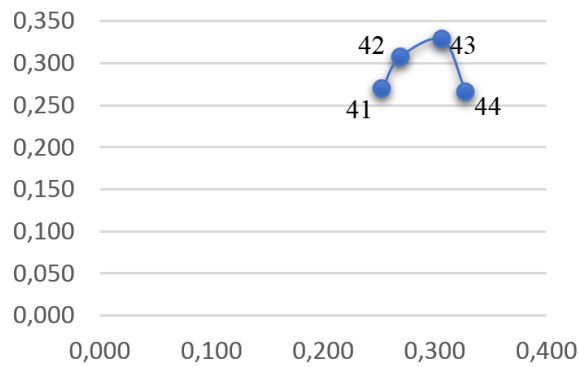

Fig. 10. The tenth quasicycle of the output timeline Z .

The dimensions L_r of these quasicycles are presented in Table 3.

Table 3. Quasicycles and their dimension are the result of a phase portrait for the time series of economic stability.

C_r	C_1	C_2	C_3	C_4	C_5	C_6	C_7	C_8	C_9	C_{10}	C_{11}
L_r	4	5	4	4	4	5	5	4	5	4	4

Compare the depth of memory of the investigated time series, which is represented by a fuzzy set (5) with the quantifiers of the quasicycles, which are reflected in the second row of Table 3. From this comparison it follows that the presence of long-term memory in the analysed time series, along with other factors, is also due to the cyclical component of this time series.

3 Conclusions

The algorithm for calculating the depth of long-term memory developed on the basis of fractal analysis showed that the depth of a particular time series is not a fixed number

but is changing. One of the reasons for this is the cyclical time-series component, based on which we can talk about the creation of predictive models.

Implementation of the considered methodology at the industrial enterprise showed that the time series of economic sustainability of the enterprise is trend-resistant. This means that the level of economic stability will remain within the trend during a certain period of further enterprise operation due to available assets and reasonable administrative policy of management.

References

1. Maksishko, N.K., Perepelica, V.A.: About two approaches to R/S analysis of time series. *Visnik of the Volodymyr Dahl East Ukrainian national university*. 5, 134 (2005)
2. Soloviev, V., Solovieva, V., Solovieva, K.: Comparative analysis of the dynamics of the stock market of Ukraine using fractal measures of complexity. *Bulletin of Cherkasy University. Series of Economic Sciences*. 33, 246 (2012)
3. Maksishko, N.K.: Estimation of system characteristics of economic dynamics based on the results of complex fractal analysis. *Herald of Zaporizhzhya National University*. 2, 10 (2011)
4. Novoselytskyy, O.: Methodology for calculating the economic stability of the enterprise in the light of risk. *Formation of market relations in Ukraine*. 11, 78 (2007)
5. SMIDA. PJSC Consumers-Sklo-Zorya (Ukraine). <https://smida.gov.ua/db/participant/22555135> (2010). Accessed 21 Mar 2019
6. Peters, E.: *Chaos and Order in the Capital Markets: A New View of Cycles, Prices, and Market Volatility*. John Wiley & Sons, New York (1996)
7. Maksishko, N.K.: About applying an algorithm of sequential R/S analysis to obtain a fuzzy estimate of the depth of memory of the time series. *Herald of Lviv University*. 516 (2006)
8. Maksishko, N.K.: *Modeling of economy by methods of discrete nonlinear dynamics*. Polygraph, Zaporizhzhya (2009)
9. Maksishko, N.K., Perepelica, V.A.: *Analysis and forecasting of the evolution of economic systems*. Polygraph, Zaporizhzhya (2006)
10. Holden, K., Peel, D.A., Thompson, J.L.: *Economic Forecasting: An Introduction*. Press Syndicate of the University of Cambridge, Cambridge (1990)
11. Melikhov, E., Ebzeeva, N.: *Mathematical modeling of economic time series based on phase portraits*. Paper presented at the International Conference "Mathematics. Economy. Education", Rostov-on-Don, May 29 – June 5 2005
12. Matviychuk, A., Novoseletsky, O., Vashchaiev, S., Velykoivanenko, H., Zubenko, I.: Fractal analysis of the economic sustainability of enterprise. *SHS Web of Conferences*. 65, 06005 (2019). doi:10.1051/shsconf/20196506005

Diagnostics of Persistence for Quotes Dynamics in High-Tech Stock Markets

Nataliia Maksyshko^[0000-0002-0473-7195] and Oksana Vasylieva^[0000-0002-6332-2707]

Zaporizhzhia National University, 66, Zhukovskogo Str., Zaporizhzhia, 69600, Ukraine
maxishko@ukr.net, oksanabay@ukr.net

Abstract. The research purpose is diagnosis of the persistence property for the stock quotes time series of leading companies belonging to the high-tech sector: Apple Inc., Microsoft Corporation and Samsung Electronics Co. The persistence property or the trend-stability of the time series is crucial meaning for the investor. As a result of the application of the R/S-analysis, it is proved that the stock quotations dynamics of these companies have the persistence property. Also, the method of sequential R/S analysis is applied: the leading characteristics of the long-term memory are discovered, which makes it possible to carry out a comparative analysis of their predictability. It is found that the time series of profitability do not have the properties of persistence. However, the tests for diagnostic of a deterministic chaos reveal the appearance of the persistence property in the time series of “delayed” profitability. The obtained results allows to state the fractal nature for the time series of quotations, while the characteristics of the persistence (depth of memory) determined by the research can be useful to the investor in terms of the investment instrument choice and the investment horizon as well as can be used in selecting the parameters for a forecasting model.

Keywords: stock market, persistence, long-term memory, Hurst exponent, R/S-analysis.

1 Introduction

Stock markets are one of the most important components of the global financial system. Created for communication between business and investors, they are now indicators of the world economy state as a whole.

An overview of stock markets and their stock segments suggests that, despite the overall positive dynamics of the world stock market, there is a cyclical nature changes in the economic performance of national stock markets and trading platforms not only in developing countries but also in highly developed countries of the world. So it can be noted that the stock market again fell at the end of 2018. Hence, before investing in certain stock market instruments, investors need to make a detailed analysis of this solution, consider all the pros and cons.

In order to conduct well-considered investment actions and make effective decisions in managing a portfolio of securities, an investor who wishes to invest should take into

account a number of factors that determine the level of risk and the list of expected results and allow making a well-balanced conclusion. At the same time it is necessary to note the significant role by modern information technologies and economic and mathematical methods for modeling processes and stock markets dynamics.

Traditionally, linear dynamics methods were used to assess the dynamics of stock markets [1-3], these methods are actively being used now [4-10]. However, in the 1990s, the nonlinear paradigm, which is represented by the hypothesis of the fractal market, began to develop actively [11, 12]. This direction became widespread and was used in works [13, 14]. Within this paradigm it was discovered that for many time series, reflecting the development processes dynamics in the socio-economic and other spheres of human activity inherent a long-term memory or the property of persistence [15, 16]. Its presence means that observations are not independent. Each observation has a memory of the events that precede it. And that is not a short-term memory, often called “Markov’s” one. This is a different type of memory – a long-term memory, theoretically it is stored permanently. Recent events have an impact larger than distant events, but the residual effect of each event is always tangible.

The persistence property or trend-stability of the time series is positive for the investor. The presence of the persistence property and, accordingly, the effect of long-term memory in the time series of the investment instrument, on the one hand, provides for better predictability of its dynamics, and, on the other hand, reduces the risks of accidental changes within the planning horizon. The purpose of this work is to diagnose the presence of the persistence properties and to identify the characteristics of long-term memory in the time series of highly liquid instruments in the high-tech segment of the stock market to obtain practical recommendations on the possibility forecasting the dynamics of these securities.

2 Materials, Methods and Results

The input data of the work were selected the value of stock quotes companies, which are American blue chips: Apple Inc. (AAPL) and Microsoft Corporation (MSFT), and the main Apple’s rival – South Korean company Samsung Electronics Co (SSUN). These companies belong to the high-tech sector, according to estimates Forbes [15] they are among the 20 largest companies in the world and have gilt-edged security [16]. The time series length is the last 10 years period – from 2009 to 2018 [17, 18].

2.1 Investigation of stock quotes time series

Consider three time series (TS) of stock quotes Apple.Inc. (AAPL), Microsoft Corporation (MSFT) and Samsung Electronics Co (SSUN) for the period from 2009 to 2018:

$$V(i) = \langle v_t(i) \rangle, t = \overline{1,2516}; \quad (1)$$

where $i \in \{AAPL, MSFT, SSUN\}$.

The visualization of the Apple.Inc., Microsoft Corporation and Samsung Electronics Co stock quotes dynamics is presented in the figure 1.

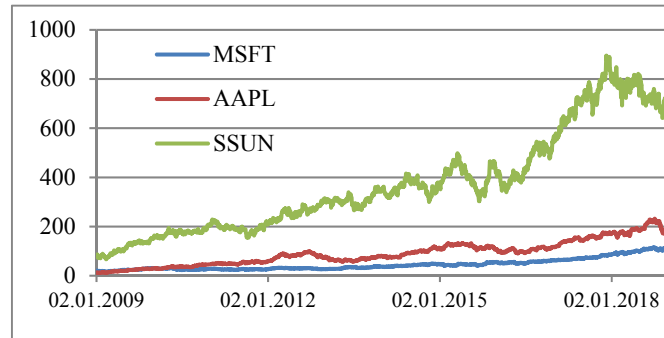

Fig. 1. Stock quotes dynamics of Apple.Inc. – V(AAPL), Microsoft Corporation – V(MSFT) and Samsung Electronics Co securities – V(SSUN) for the period from 2009 to 2018.

One of the most common indicators that diagnoses memory in time series, and, consequently, nonlinearity is the Hurst exponent.

If the system for a sufficiently long period of time shows a high value of the Hurst exponent H , this indicates interrelated events. As a measure of interrelated events, it is known there is a correlation coefficient. The influence the present-day to the future can be given by the following correlation ratio [11]:

$$C = 2^{2H-1} - 1, \quad (1)$$

where C – measure of correlation, H – Hurst exponent.

If $H \in (0.5; 1]$, then TS is persistent or trend-resistant [11, 12] and is characterized by the effect of long-term memory. The events are all the more correlated, the closer the value of H to 1 (C is also close to one or to 100% correlation according to (1)).

We apply R/S-analysis [11, 12] to the output time series. The results of R/S-analysis are shown in Table 1. This indicates the existence of the persistence properties in the output time series. This fact is also confirmed by the results of a mixing test (Table 1). According to its results, the Hurst exponents for the mixed time series are close to 0.5.

Table 1. Hurst exponents for the time series and mixed time series of Apple Inc., Microsoft Corporation and Samsung Electronics Co stock quotations from 2009 to 2018.

V (i)	H	H_{mixed}
V (AAPL)	0.965	0.587
V (MSFT)	0.953	0.539
V (SSUN)	0.964	0.571

To avoid false judgments, let's take into account the experience of the previous researches on the particularities of calculating the Hurst exponent: with an increase in

the length of a series, the Hurst exponent tends to be overestimated. To take into account this feature, we calculate the Hurst exponent for the last year from the study period:

$$V^{2018}(i) = \langle v_t(i) \rangle, t = \overline{1,251}$$

where $i \in \{\text{AAPL, MSFT, SSUN}\}$.

As a result of calculations, we get the Table 2.

Table 2. Hurst exponents for the time series and mixed time series of Apple Inc., Microsoft Corporation and Samsung Electronics Co stock quotations per 2018

V (i)	H	H_{mixed}
V (AAPL)	0.912	0.605
V (MSFT)	0.91	0.545
V (SSUN)	0.904	0.631

The obtained values are confirmed by our assumption that the stock quotes time series (TS) of three companies have the property of persistence, and, as a result, the presence of long-term memory.

However, the Hurst exponent characterizes the behavior of the time series in the whole, but does not allow quantifying the memory depth of the time series. Because over time, this characteristic may change, so we do not deal with a uniquely determined value, but with a value that is characterized by uncertainty: the depth of memory can take some value from the set of possible values. For its description and definition, we use the sequential R/S-analysis method specified in [19]. The result of this method is the construction of a memory depth fuzzy set:

$$L(i) = \{(l, \mu(l)), l \in L^0\}$$

Graphical representations of the memory depth fuzzy set for each time series are shown in the Figure 2.

The value of the membership function $\mu(l)$ determines the degree of belonging of the natural number l ("depth l ") to the fuzzy set $L(i)$. Therefore, to characterize and compare the behavior of time series, it is important to establish, firstly, the memory depth that is most commonly found in the time series, and secondly, the range of time slices l for which the trend-stability of the series is typical (the value of the membership function μ exceeds 0.6). This information is presented in Table 3.

Table 3. Information about the fuzzy set of memory depths for stock quotations.

V (i)	The range l , if $\mu(l) \geq 0.6$	Memory depth l with the largest $\mu(l)$
V(AAPL)	8-15 days	9 days
V(MSFT)	9-17 days	15, 14 days
V(SSUN)	6-18 days	11 days

Thus, it is found that all three time series have close values of memory depth. However, if for AAPL and SSUN securities they are 9 and 10, 11 days respectively,

then MSFT is 15 days. At the same time for this time series (MSFT) there is the smallest range of depth distribution - from 9 to 17 days. The obtained results allow us to assert that the long-term influence of the previous values of a series on its subsequent ones exists. And in comparison with other three securities the most stable time series is V(MSFT). This can be used as an advantage in assessing the risk of investing, predictability of its outcome and, consequently, to determine the investment horizon.

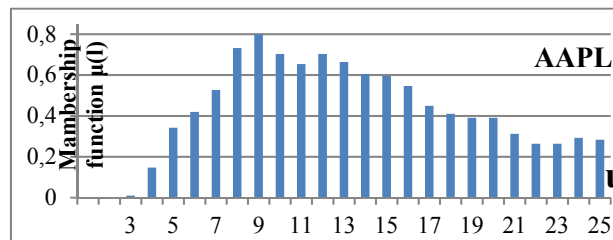

a)

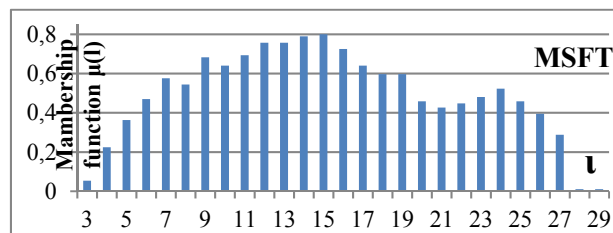

b)

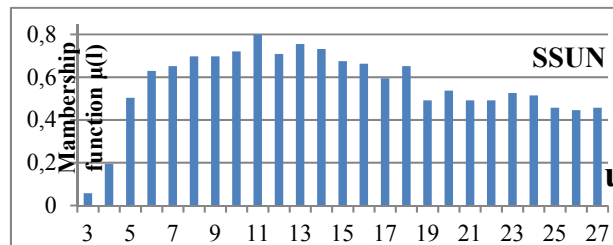

c)

Fig. 2. Fuzzy set $L(i)$ of memory depths for the time series of Apple Inc. (a), Microsoft Corporation (b) and Samsung Electronics Co (c) securities.

Thus, in analyzing stock quotations of selected companies, their fractality was established, which enabled the use of discrete nonlinear dynamics methods to obtain important characteristic indicators of the dynamics of these time series.

2.2 Profitability time series of stock quotations

In the analysis of stock quotations on the financial market it is accepted to work not only with the sequence of absolute prices, but with the sequence of relative changes, that is, the yield or profitability of the security.

The sequence of relative prices has certain advantages over the sequence of prices.

First, the transformation of the price sequence into the sequence of relative changes allows for greater comparability of different assets.

Secondly, for the sequence of relative changes, the average and variance are more stationary than the average and variance of the sequence of absolute prices values [20, 21].

We find out the question of the persistence properties availability for the time series of the above financial instruments (stock quotations).

Consider the profitability TS calculated by the formulas:

$$P(i) = \langle p_t(i) \rangle, \quad (3)$$

$$p_t(i) = \frac{(v_t(i) - v_{(t-1)}(i))}{v_{(t-1)}(i)} * 100\%, \quad (4)$$

where $v_t(i)$ – the quotation of the investment instrument at a day t , $i \in \{AAPL, MSFT, SSUN\}$.

The obtained time series of profitability are checked for the existence of persistence properties using the Hurst exponent. The Hurst exponents for stock quotations profitability are close to 0.5 (Table 4), indicating the random nature of the changes in the increment of quotations and the absence of internal ties between events.

Table 4. The Hurst exponents for the profitability time series depending on the value of lag.

i	The Hurst exponent for $P_s(i)$							
	S=1	S=5	S=10	S=15	S=18	S=21	S=25	S=42
AAPL	0.58	0.71	0.77	0.80	0.82	0.83	0.84	0.87
MSFT	0.55	0.699	0.76	0.79	0.80	0.81	0.83	0.85
SSUN	0.54	0.66	0.73	0.77	0.78	0.80	0.81	0.84

The obtained Hurst exponents show there are no signs of fractality in the selected time series. In this way, families of profitability time series with a certain lag were constructed and investigated [22].

The time series of the “delayed” profitability are constructed by the formula:

$$p_t^s(i) = \frac{(v_t(i) - v_{(t-s)}(i))}{v_{(t-s)}(i)} * 100\%, \quad (5)$$

where $v_t(i)$ – the quotation of the investment instrument at a day t ; s – is a lag value.

Then profitability time series is equal to:

$$P_s(i) = \langle p_t^s(i) \rangle, \quad (6)$$

where $i \in \{AAPL, MSFT, SSUN\}$.

However, the question remains: how quickly this property acquires the time series of so-called “delayed profitability”.

The character of the profitability dynamics varies depending on the magnitude of the time lag (Table 4) and, as it grows, the time series acquire the properties of persistence (the property of memory).

The graphic representation of the Hurst exponent dependence on the lag is shown in Figure 3:

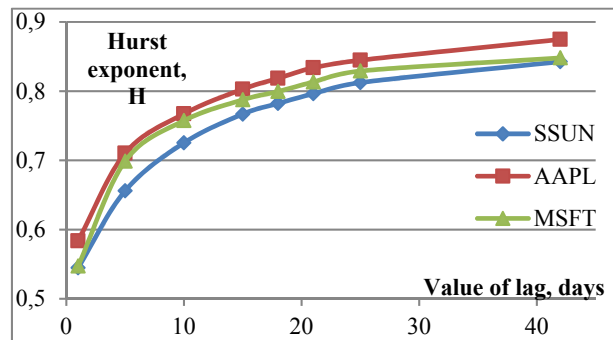
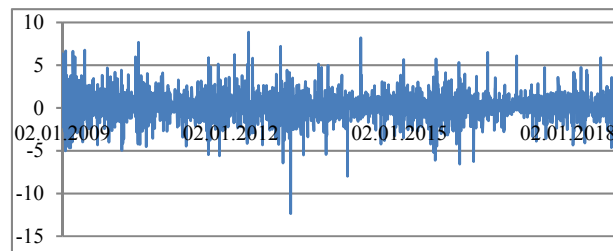
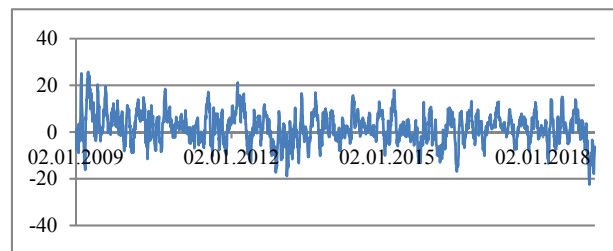

Fig. 3. Hurst exponent depending on the value of lag.



a)



b)

Fig. 4. Dynamics of profitability time series for Apple Inc. (AAPL) with: a) lag 1; b) lag 15.

Figure 5 shows that the Hurst exponent grows parabolic with increasing lag magnitude. The persistent one is that time series, if its Hurst exponent equal to or greater than 0.8.

Moreover, the growth rate of H in the profitability of different securities is different: for AAPL this lag is 15 days, for MSFT – 18 days, for SSUN – 21 days.

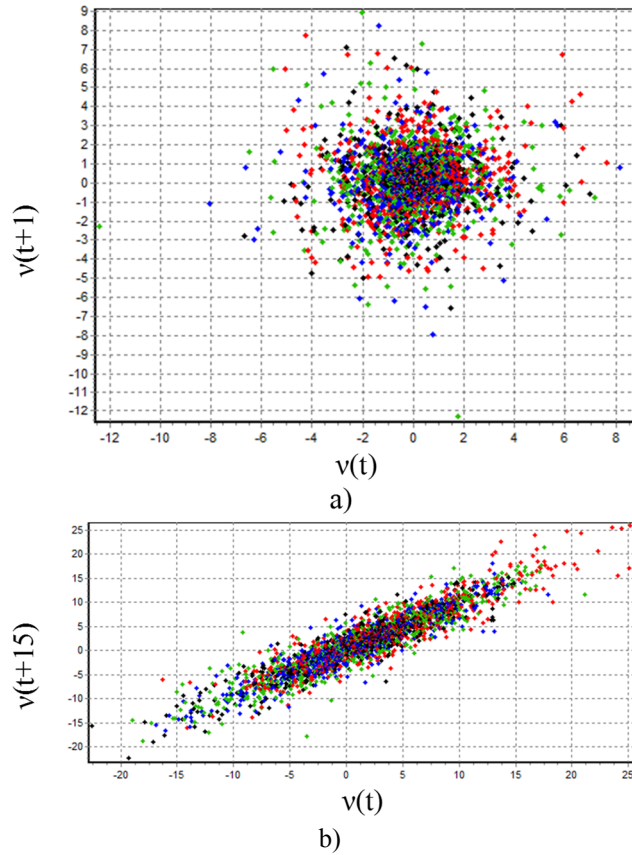

Fig. 5. Pseudo-phase spaces with tests on a drifting attractor for profitability time series of AAPL with: a) lag 1 – P_1 (AAPL); b) lag 15 – P_{15} (AAPL).

For the received persistent time series we carry out their diagnostics for the presence in their structure of deterministic chaos. Since the results of the AAPL, MSFT, and SSUN profitability are similar, we consider the results of the tests for AAPL stock quotations. Figure 4 shows the profitability TS for Apple shares with the lag 1 (a) and 15 (b).

Figure 4 shows how the time series structure changes and how periods of growth or decline in profitability appear. Moreover, not one of the time series has any signs of stationary behavior, this means the expediency of further diagnostics by the methods of deterministic chaos [23].

At the next stage, pseudophase spaces are constructed and drift attractor' tests are performed. Graphic representation is shown in Figure 5.

The construction of the pseudophase space allows to establish the relationship between the events of the series in time for the delayed profitability and to put forward the hypothesis of the attractor presence. Conversely, the time series of the AAPL

profitability with the lag 1 shows accumulation near the point (0, 0) with a random deviation from it. That is, for the time series of profitability $P_1(\text{AAPL})$, the hypothesis regarding the presence of such deterministic chaos features as a drifting attractor or joker is rejected, and events of the time series are defined as independent of each other.

Figure 6 shows a graphical representation of the Gilmore test [24].

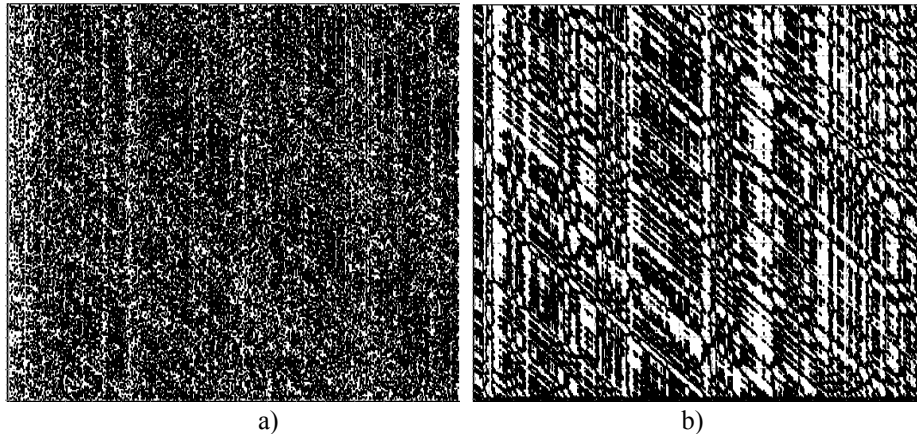

Fig. 6. Gilmore graphic test for profitability time series of AAPL with: a) lag1 – $P_1(\text{AAPL})$; b) lag 15 – $P_{15}(\text{AAPL})$.

The Gilmore test demonstrates changes in the dynamics of the two time series $P_1(\text{AAPL})$ and $P_{15}(\text{AAPL})$ from random to deterministic chaos. Figure 6 b) shows the presence of close trajectories, as well as empty sections and diagonal bands, which may indicate an interval joker.

Thus, the resulting time series of delayed profitability acquire characteristics of fractal dynamics (deterministic chaos) and become suitable for analysis by nonlinear dynamics methods. Using the sequential R/S-analysis method [19] we obtain the values of the depth memory, which characterizes the ranges of the trend-stability of the time series (Figure 7).

Table 5 shows the memory depth l with the largest value of the membership function $\mu(l)$ and the time period for which the membership function $\mu(l)$ exceeds the value of 0.6.

Table 5. Information about the fuzzy set of memory depths for the delayed profitability time series.

$P_s(i)$	The range l , if $\mu(l) \geq 0.6$	Memory depth l with the largest $\mu(l)$
$P_{15}(\text{AAPL})$	6-13, 15	12
$P_{18}(\text{MSFT})$	10-16	11
$P_{21}(\text{SSUN})$	8-14	9

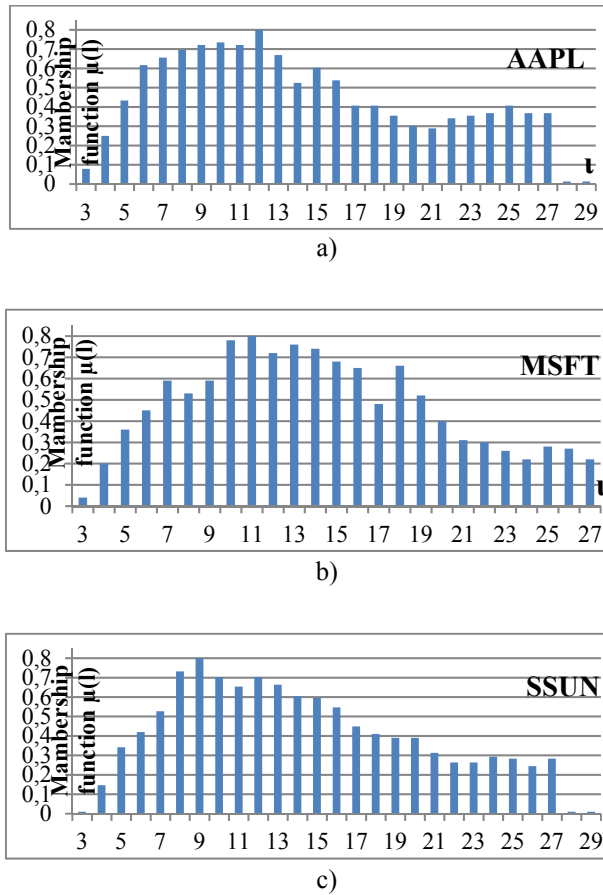

Fig. 7. Fuzzy set of memory depths for the profitability time series of: a) AAPL with lag 15 days; b) MSFT with lag 18 days; c) SSUN with lag 21 days.

From table 5 it follows that the most persistent is the time series P_{15} (AAPL), despite the least time lag s .

3 Conclusions

The persistence property or trend-stability of the time series is crucial for the investor. The presence of persistence and, accordingly, the effect of long-term memory in the time series of the investment instrument, on the one hand, provides for better predictability of its dynamics, and, on the other, reduces the risk of accidental changes within the planning horizon. In this work, a diagnostic of the persistency are conducted for the stock quotations time series of Apple Inc., Microsoft Corporation, and Samsung Electronics Co., Ltd.

As a result of the application of the normalized Hurst range (R/S-analysis), it is proved that the stock quotations dynamics of these companies have the persistence property. Applying the sequential R/S analysis method, the leading characteristics of the long-term memory are discovered, it makes possible to carry out a comparative analysis of their predictability.

At the next stage, time series of stock returns (the profitability time series) were studied. It was found that the profitability time series do not have the properties of persistence, and the values of profitability are independent of each other. However, the use of the drift attractor test and the Gilmore test, as well as R/S-analysis, allows revealing the appearance of the persistence property in the “delayed” profitability time series. For persistent time series of profitability, fuzzy sets of memory depths were built and time intervals for which memory is characteristic were revealed.

The set of results obtained allows us to assert the fractal nature of the quotations time series, while the characteristics of the persistence (depth of memory) determined by the research can be useful to the investor in terms of the investment instrument choice and the investment horizon as well as can be used in selecting the parameters of the forecasting model.

References

1. Fama, E.: Random walks in stock market prices. *Financial Analysts Journal*. **21**(5), 55–59 (1965)
2. Fama, E.: Efficient capital markets: a review of theory and empirical work. *J. of Finance*. **25**, 383–417 (1970)
3. Fama, E.: Efficient Capital Markets: 2. *J. of Finance*. **46**(5), 1575–1617 (1991)
4. Gümüs, F., Zeren, F.: Analyzing the Efficient Market Hypothesis with the Fourier Unit Root Test: Evidence from G-20 Countries. *Ekonomski horizonti*. **16**(3), 225–237 (2014)
5. Gupta, N., Gedam, A.: Testing of Efficient Market Hypothesis: a study on Indian Stock Market. *J. of Business and Management*. **16**(8), 28–38 (2014)
6. Chen, C., Metghalchi, M.: Weak form market efficiency: Evidence from the Brazilian stock market. *Intern. J. of Economics and Finance*. **4**(7), 22–32 (2012)
7. Ananzeh, I.E.N.: Testing the weak form efficient market hypothesis: Empirical evidence from Jordan. *Intern. Business and Management*. **4**(2), 119–123 (2014)
8. Ogbulu, O.M.: Weak-form market efficiency, estimation interval and the Nigerian stock exchange: empirical evidence. *Intern. Academy of Business Review*. **3**(1), 42–61 (2016)
9. Onali, E., Goddard, J.: Are European equity markets efficient? new evidence from fractal analysis. *International Review of Financial Analysis* **20**, 59–67 (2011)
10. Singh, S.K., Singh, K.B.: Market reaction around mergers and acquisitions announcements in India: a test of Efficient Market Hypothesis. *Gurukul Business Review-Gbr*. **13**, 37-41 (2017)
11. Peters, E.: Chaos and order in the capital markets – a new view of cycles, prices, and market volatility. John Wiley & Sons, Inc., New York (1991)
12. Peters, E.: Fractal market analysis. Applying chaos theory to investment and analysis. John Wiley & Sons, Inc., New York (1994)
13. Wang, X.Y., Lei, T., Liu, Z., Wang, Z.B.: Long-memory behaviour analysis of china stock market based on Hurst exponent. Paper presented at the 29th Chinese Control And Decision Conference (CCDC), Peoples R China, Chongqing, 28-30 May 2017

14. Erokhin, S., Roshka, O.: Application of fractal properties in studies of financial markets. Paper presented at the International Scientific Conference on Business Technologies for Sustainable Urban Development (SPbWOSCE), Peter Great Saint Petersburg Polytechnic University, Inst Ind Management Econ & Tr, St Petersburg, 20-22 December 2017
15. Forbes Global 2000: The world's largest public companies. June 6, 2018. <https://www.forbes.com/global2000/#3e840633335d> (2018). Accessed 05 March 2019
16. Financial portal Nasdaq. <https://www.nasdaq.com/investing/glossary/b/blue-chip-company> (2018). Accessed 05 March 2019
17. Yahoo Finance. <https://finance.yahoo.com/> (2018). Accessed 01 Feb 2019
18. Global financial portal Investing.com. <https://www.investing.com> (2018). Accessed 01 Feb 2019
19. Maksyshko, N.K.: Modeliuvannia ekonomiky metodamy dyskretnoi nelinejnoi dynamiky (Modeling of economics by methods of discrete nonlinear dynamics). Polihraf, Zaporizhzhia (2009)
20. Bidyuk, P.I.: Prognosis of volatility of financial processes for alternative models. Sciences. Visti NTUU "KPI". **6**, 36–45 (2012)
21. Borimsky, Yu.S.: Algorithms of the investment portfolio of the investment and the assignment of active parts in the investment capital. Sciences. Visti NTUU "KPI". **3**, 5–10 (2009)
22. Vasylieva, O.V., Maksyshko, N.K.: Research of dynamics in the gold market: the investment aspect. Investytsiyi: praktyka ta dosvid. **19**, 8–15 (2017)
23. Sergeeva, L.N.: Nelineynaya ekonomika: modeli i metody (Nonlinear Economy: models and methods). Polihraf, Zaporizhzhia (2003)
24. Gilmore, C.G.: A new test for chaos. J. of economic behavior and organization. **22**, 209–237 (1993)
25. Maksyshko, N., Vasylieva, O.: Diagnostics of a persistence property for quotations dynamics on high-tech stock markets. SHS Web of Conferences. **65**, 06009 (2019). doi:10.1051/shsconf/20196506009

Author Index

B

Vitalina Babenko	345, 444
Anna Bakurova	284
Vitaly Bezkorovainyi	320
Andrii Bielinskyi	420
Olha Bilaska	371
Liliia Bodnar	274
Anton Boiko	297
Victoria Bozhenko	134
Iryna Buchatska	15

C

Oleksandr Chernyak	181
Iia Chudaieva	54

D

Nadiia Daliak	444
Hanna Danylchuk	1, 211
Natalia Datsenko	320
Oksana Davydova	345
Nadiya Dekhtyar	100
Viktoriya Denysenko	249
Vasily Derbentsev	320
Olga Deyneka	100
Ivan Donchev	274
Tetiana Dotsenko	297
Tatiana Dubovyk	15
Kathrin Dumanska	121

F

Yurii Filei	284
-------------	-----

G

Leonid Galchynsky	66
Vyacheslav Glushchevsky	405
Illona Gorbachova	5
Kateryna Gorbatiuk	194
Svitlana Grygoruk	169

H	
Nataliia Havadzyn	157
Valery Heyets	308
Liliana Horal	157
Pavlo Hryhoruk	169
I	
Mykola Ivanov	395
Sergey Ivanov	385
Oksana Ivanylova	27
Larysa Ivashko	357
K	
Liubov Kibalnyk	1, 211
Arnold Kiv	1, 274
Anatoliy Kholodenko	308
Nila Khrushch	169
Inesa Khvostina	157
Olena Kolotilina	134
Anna Kostenko	5
Bohdan Koval	38
Oksana Kovtun	27
Tatyana Koycheva	274
Olena Kravchenko	434
Hanna Kucherova	371
Zdzisław Kulczyk	345
Tatyana Kungurtseva-Mashchenko	5
Olha Kuzmenko	134
L	
Serhiy Leonov	297
Maryna Leshchenko	434
Dean Linok	147
Vita Los	237
M	
Andriy Makarenko	226
Olena Makarenko	54
Liubov Makhanets	335
Nataliia Maksyshko	467
Olha Mantalyuk	194
Dariia Marushchak	434
Maksym Matskul	147
Andriy Matviychuk	1, 455
Tetiana Melikhova	226

Olena Mikhailytsa	226
Iryna Moroz	15
N	
Oleksandr Novoseletskyy	455
O	
Dmytro Ocheretin	237
Alla Opalenko	27
Oleksandr Ostapenko	111
P	
Mariia Pasichnyk	284
Iryna Perevozova	345, 444
Nataliya Ponomaryova	121
Vasyl Porokhnya	111
Andriy Pozhuyev	226
Oksana Proskurovych	194
Oleg Pursky	15
R	
Svitlana Radziyevska	84
Sultan Ramazanov	181
S	
Sergii Sardak	84
Anastasiia Savchuk	15
Serhiy Semerikov	1, 420
Olexandr Serdiuk	211
Liudmyla Serhieieva	54, 371
Volodymyr Shinkarenko	147
Viktor Shpyrko	38
Vladimir Soloviev	1, 420
Viktoria Solovieva	420
Oksana Sotula	249
Olga Stepanenko	320
Nina Stepanok	308
Andriy Svydenko	66
Olga Syniavska	100, 345
T	
Elina Tereschenko	284
Bogdan Tishkov	181
Denis Trček	263

U

Galyna Us	54
Ivan Us	84

V

Oleksandr Valkov	194
Serhii Vashchaiev	455
Tetyana Vasilyeva	134
Oksana Vasylieva	467
Yuriy Vdovychenko	434
Halyna Velykoivanenko	455
Alina Vinkovska	274
Valdemar Vitlinskyi	335, 405
Mykhaylo Voynarenko	121, 308

Y

Hanna Yarovenko	297
Nataliia Yurchenko	157

Z

Pavel Zakharchenko	5
Tetiana Zhukova	100
Tetiana Zhuravlova	357
Yuliya Zhuravlova	357
Igor Zubenko	455